

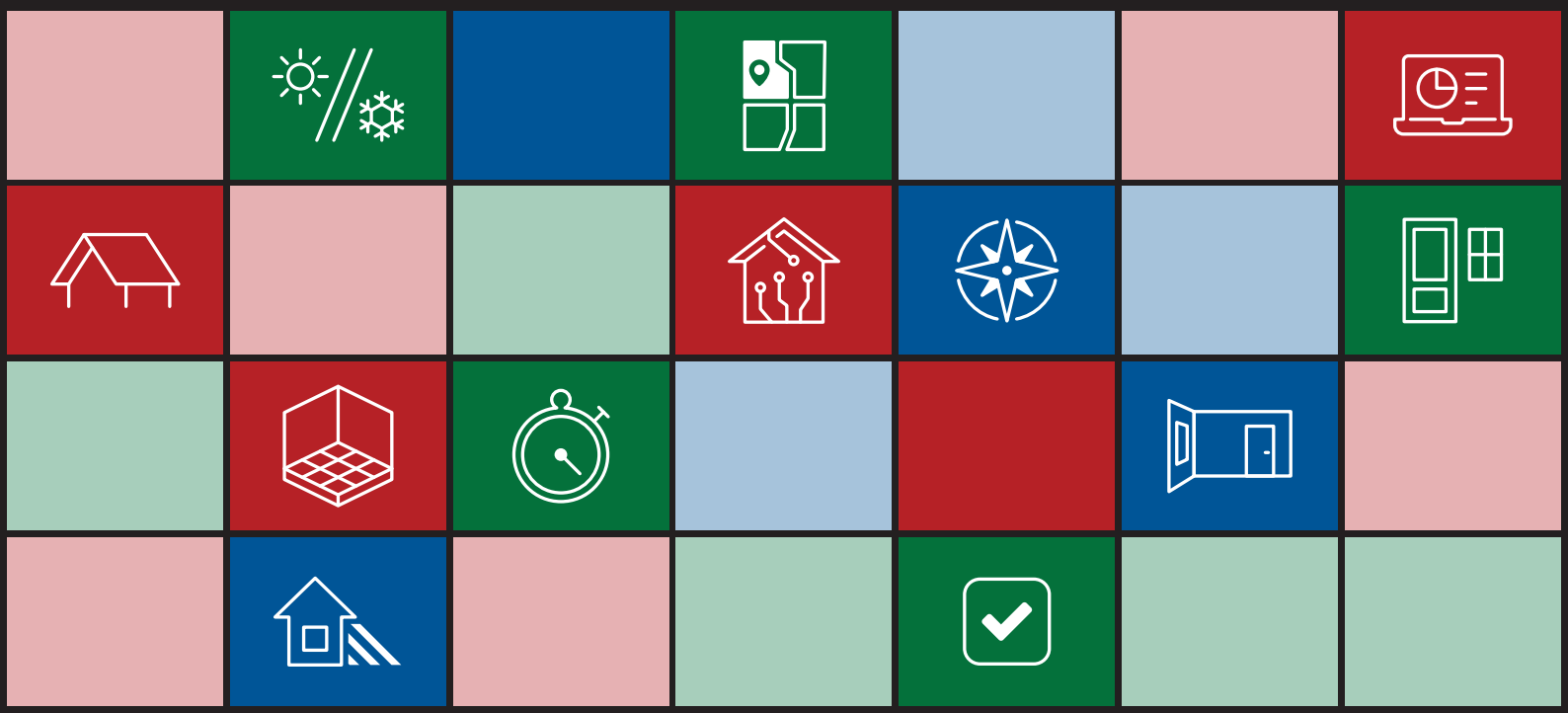

NatHERS

Assessor Handbook



Publication information

© Commonwealth of Australia 2024



NatHERS assessor handbook is licensed by the Commonwealth of Australia for use under a Creative Commons Attribution 4.0 International licence with the exception of the Coat of Arms of the Commonwealth of Australia, the logo of the agency responsible for publishing the report and some content supplied by third parties. For licence conditions, see creativecommons.org/licenses/by/4.0.

Citation

DCCEEW (2024). *NatHERS assessor handbook*, Australian Government Department of Climate Change, Energy, the Environment and Water.

Disclaimer

The material in this document is to be followed by accredited assessors and is made available for assessors who use NatHERS accredited software in 'regulatory' mode only and on the understanding that the NatHERS Administrator, the state and territory governments, and the Commonwealth Government (the Participating Bodies) are not providing professional advice, nor indicating a commitment by the Participating Bodies to a particular course of action. While reasonable efforts have been made to ensure the information is accurate, correct and reliable, the Participating Bodies, and all persons acting for the Participating Bodies preparing this publication, accept no liability for the accuracy of, or inferences from, the material contained in this publication, and expressly disclaim liability for any person's loss arising directly or indirectly from the use of, inferences drawn, deductions made, or acts done in reliance on this document. The material in this document may include the views or recommendations of third parties, which do not necessarily reflect the views of the Participating Bodies or indicate their commitment to a particular course of action.

Contents

	Chapter 1: <u>Introduction</u>	4
	Chapter 2: <u>Before you start</u>	8
	Chapter 3: <u>Data entry and retention</u>	19
	Chapter 4: <u>Climate, exposure, ground reflectance and orientation</u>	24
	Chapter 5: <u>Zoning</u>	30
	Chapter 6: <u>Floors</u>	50
	Chapter 7: <u>Walls</u>	58
	Chapter 8: <u>Windows and doors</u>	68
	Chapter 9: <u>Ceilings and roofs</u>	94
	Chapter 10: <u>Shading</u>	112
	Chapter 11: <u>Thermal bridging</u>	127
	Chapter 12: <u>Appliances (Whole of Home assessments only)</u>	138
	Chapter 13: <u>Finalising the assessment</u>	161
	Chapter 14: <u>Definitions</u>	172





The Nationwide House Energy Rating Scheme (NatHERS) provides building energy performance ratings and information to help improve Australian homes. Understanding how energy is used to heat and cool a home helps to make Australian homes more comfortable and helps people save on energy bills through smarter design choices. This handbook explains how NatHERS assessments work and is an essential tool for NatHERS assessors.

Nationwide House Energy Rating Scheme

NatHERS supports improvements to the energy efficiency of Australia's residential dwellings by providing a national standardised approach for energy rating assessment tools used for rating dwellings. NatHERS is administered by the Australian Government on behalf of the state and territory governments.

NatHERS uses a 10-star rating system to provide estimates of a home's thermal performance (heating and cooling needs). Star ratings are based on information about the home's design, energy performance, construction materials and the climate where it is built.

Each star band is defined by a maximum thermal energy load. Each energy load for a star band varies by climate zone. The star bands for different climate zones are available on the NatHERS website:

[www.nathers.gov.au/files/publications/NatHERS Star bands.pdf](http://www.nathers.gov.au/files/publications/NatHERS%20Star%20bands.pdf).

NatHERS star ratings and information can be used by building surveyors and certifiers, homeowners, prospective home buyers, builders, developers and national, state and local governments for a number of purposes, including to:

- verify that the residential dwelling meets the mandatory thermal energy efficiency requirements for new homes and major renovations/building additions required under the National Construction Code (NCC) and state and territory requirements
- compare the energy efficiency of various building designs.

NatHERS assessments are conducted by trained assessors using purpose-built assessment tools (see [Section 2.1](#)). An overview of the assessment process is provided in [Figure 1-1](#).

The Chenath engine

All NatHERS energy rating assessment tools are underpinned by, or benchmarked against, the Chenath engine. The Chenath engine has been developed by the Commonwealth Scientific and Industrial Research Organisation (CSIRO) and is based on decades of scientific research on the way residential dwellings operate in Australian conditions. It uses climate data and average user behaviour, among other factors, to predict annual energy requirements for residential dwellings.

A basic overview of how NatHERS assessment tools work is available on the NatHERS website:

www.nathers.gov.au.



1. INTRODUCTION

Understanding the workings of the Chenath engine may also be helpful to assessors. Behavioural settings and assumptions made by the Chenath engine include thermal properties of building materials, location climatic data, infiltration rate and air flow, internal heat gains, thermostat settings and operational behaviours. More detail about these underlying assumptions can be found in the Chenath repository:

<https://hstar.com.au/Home/Chenath>.

The handbook

This NatHERS assessor handbook has been developed by the NatHERS Administrator in conjunction with industry experts.

It is designed to help assessors navigate the NatHERS assessment process by describing how assessments are to be conducted, including the mandatory and recommended steps of the process. [Figure 1-1](#) outlines the typical NatHERS assessment and rating process.

This handbook also presents information that can assist assessors, regardless of which assessment tool is used. For guidance on undertaking activities in a specific assessment tool, assessors should contact their software tool provider for a copy of their specific assessment tool manual or Frequently Asked Questions.

Release of the handbook

This handbook is designed to be a living document that will be updated occasionally and in alignment with updates of the NatHERS Technical Note. Assessors are responsible for ensuring they are using the current version of the handbook. The version number of each chapter can be found at the footer of each page. Notification of updates will be published on the NatHERS website and communicated to state and territory building authorities and assessors. The latest version of the handbook is available for download on the NatHERS website: www.nathers.gov.au. Assessors can suggest the development of new content by contacting their Assessor Accrediting Organisation (AAO).

The NatHERS website also includes the Assessor Handbook version register outlining a summary of the latest versions and any previous updates. Minor amendments will be represented by a decimal point increment and will not include fundamental changes to the assessment guidance. Major amendments will be represented by a whole number increment and will represent significant content updates or amendments altering assessment guidance or processes.

Structure of the handbook

This handbook is divided into chapters based on building and environmental elements, and assessment tool functions:

1	Introduction	8	Windows and doors
2	Before you start	9	Ceilings and roofs
3	Data entry and retention	10	Shading
4	Climate, exposure, ground reflectance and orientation	11	Thermal bridging
5	Zoning	12	Appliances (Whole of Home assessments only)
6	Floors	13	Finalising the assessment
7	Walls	14	Definitions

The key requirements that must be followed to obtain a NatHERS assessment in regulatory mode are numbered and summarised at the beginning of each chapter.



Assessor requirements

Assessors who are accredited under NatHERS are professionals who are qualified to conduct NatHERS assessments using NatHERS accredited software tools and are members of an AAO. As requirements differ between states and territories, assessors should contact the relevant state or territory building regulator about any specific requirements for that state or territory.

This handbook is intended to be a helpful resource for all assessors. When conducting assessments, assessors must still follow the requirements of the current NatHERS Technical Note and the relevant state or territory requirements.

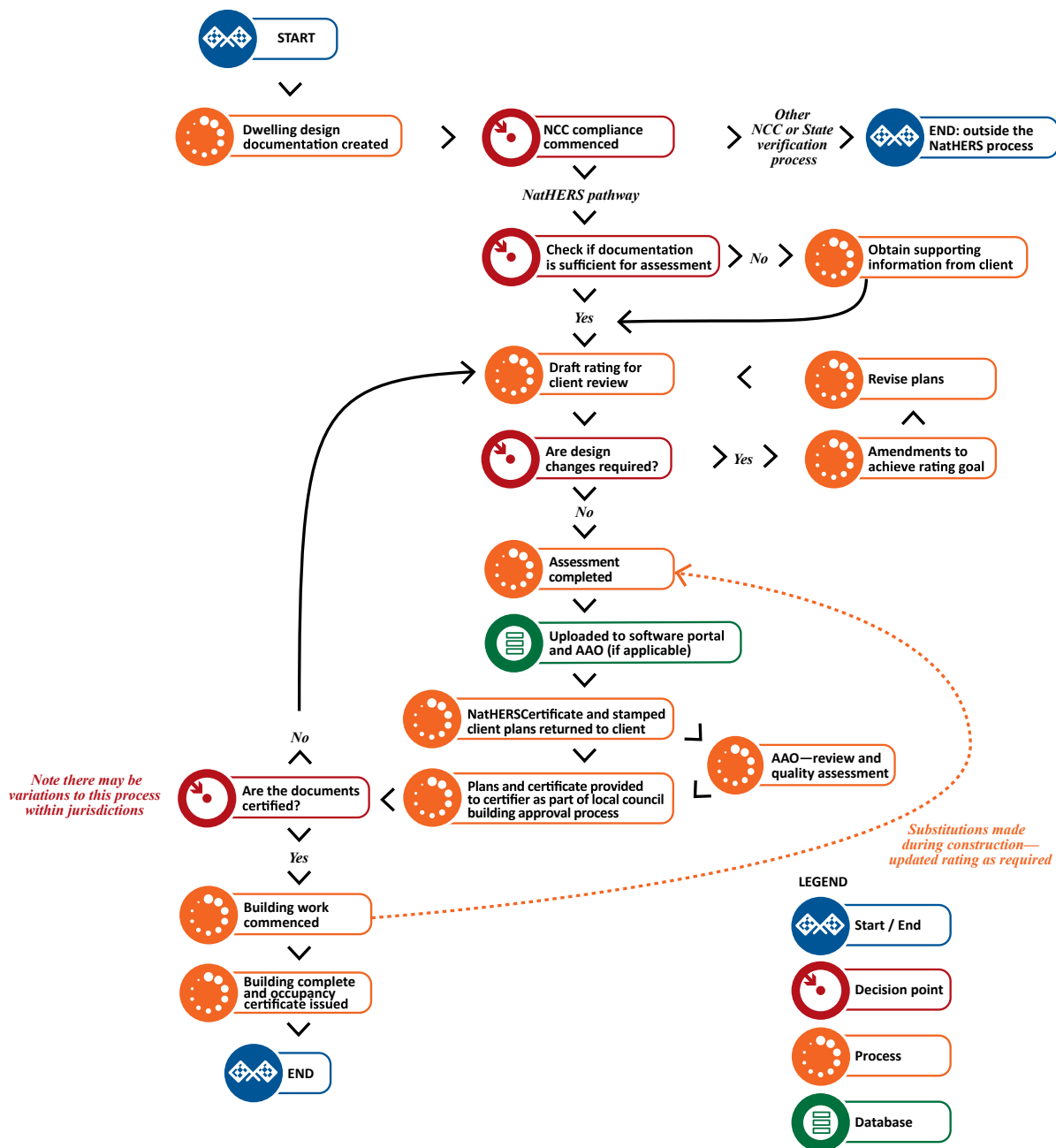

Figure 1-1: NatHERS Assessment and Rating Process

1. INTRODUCTION

NatHERS Technical Note

This handbook contains information that further explains or clarifies the NatHERS Technical Note (version October 2023). Where information relates directly to specific Tech Note clauses, the number of the clause has been provided as a reference.

Note that the guidance in this handbook is nonbinding; it supports and does not replace the use of the current Technical Note. Where there appears to be conflicting guidance between the current Technical Note and this handbook, the Technical Note takes precedence.

The NatHERS Technical Note is available on the NatHERS website: <https://www.nathers.gov.au/publications/nathers-technical-note>

Jurisdictions

The information outlined in the NatHERS Technical Note must be used by all assessors unless other state or territory regulatory obligations apply.

State or territory regulatory obligations prevail in all cases where there is a conflict between this handbook and the jurisdictional obligation, noting that jurisdictions may have alternate modelling methods to meet the NCC requirements. It is an assessor's responsibility to be aware of specific modelling requirements and to seek guidance from the relevant jurisdiction regarding any conflicts between jurisdictional obligations and the guidance in this handbook. Refer to the NCC for jurisdictional variations and the relevant state or territory authority, department and/or local council for requirements within that jurisdiction: www.abcb.gov.au.

Other guides

There may be some complex modelling situations and/or construction materials that are not covered in this handbook. Where a situation is not covered, assessors should refer to specific assessment tool manuals for guidance. If assessors are still unclear about how to proceed, or if there is uncertainty about construction material specification or how to interpret information, assessors should contact their AAO or the NatHERS Administrator at admin@nathers.gov.au for modelling advice. Only assessment tool providers can provide guidance on specific software tool issues or questions.

Further information

All enquiries and requests for additional information should be referred to either:

- the relevant AAO
- the relevant state or territory building regulator.

All enquiries and comments specifically about this handbook should be referred to the NatHERS Administrator at admin@nathers.gov.au.

For further information, visit the NatHERS website: www.nathers.gov.au.





IN THIS CHAPTER

2.1	Software tools	10
2.2	Documentation	11
2.3	Default settings	13
2.4	Individual ratings	13
2.5	Assessment goal	15
2.6	Principles of thermal performance	15





Before starting an assessment, an assessor will need to be familiar with the requirements of the National Construction Code (NCC), NatHERS accredited software tools and project documentation, and have an understanding of the relevant state or territory and local authority requirements, and the assessment goals the client requires.

This chapter provides introductory information on how the software tools are to be used, what documentation will be required for certification, default settings, individual rating requirements, assessment goals and the principles of thermal performance.

Summary of key requirements

This handbook is intended to be a helpful resource for all assessors. When conducting assessments, assessors must still follow the requirements of the current NatHERS Technical Note and the relevant state or territory requirements.

- 2a** Assessors must use NatHERS accredited software tools to obtain certification of a NatHERS assessment.
- 2b** Software tools accredited under NatHERS, to which this handbook applies, are intended to be used for assessing new dwellings and renovations where these renovations trigger NCC compliance for the dwelling. This includes Class 1, 2 or 4 buildings and attached Class 10a buildings.
- 2c** Minimum documentation required to complete an assessment includes:
 - drawing set (site plan, floor plan, elevations and sections) with a true north point
 - electrical schedule and appliance, solar panel, battery and pool specifications
 - construction details
 - window and door information.
- 2d** If the details in **2c** are not present on the drawing set or in the documentation, the drawing set or documentation must be clarified with the designer or client and the details added or amended except where default values apply. Prior to producing the final NatHERS Certificate, details on the drawing set and relevant schedules, addendums and specifications must align with the assessment. (**Tech Note clauses 3.3, 13.1**)
- 2e** If the drawing set and documentation is missing information, assessors must clarify the information. Where clarification has been sought but not received, or is unknown, an assessment must be undertaken using the default values in the NatHERS Technical Note.

2. BEFORE YOU START

- 2f** Where information is ambiguous or inconsistent, clarification must be sought from the designer or client and any appropriate revisions must be made to the design documentation before issuing the NatHERS Certificate.
- 2g** Assessors must advise the designer or client if default values are used and that some default values represent a worst-case scenario and the rating may be adversely affected.
- 2h** Every dwelling must have its own individual rating and NatHERS Certificate.
- 2i** Where a number of Class 2 multi-unit buildings are located in close physical proximity, as part of the same development or where the strata plan identifies separate lots, a summary certificate must be completed for each building/lot separately.
- 2j** NatHERS software tools must not be used to rate only a part of a dwelling. Any rating for an addition to, or extension of, an existing dwelling must include both the existing and proposed areas of the dwelling.
- 2k** The drawing set and all documentation must be retained by the assessor and produced if audited or quality assured.

2.1 Software tools

2a Assessors must use NatHERS accredited software tools to obtain certification of a NatHERS assessment.

There are currently four software tools in Australia that are accredited to assess compliance with the thermal energy efficiency requirements in the National Construction Code:

- AccuRate: developed by CSIRO
- BERS Pro: owned and maintained by Energy Inspection
- House Energy Rating & Optimisation (HERO): developed by HERO Software
- FirstRate5: developed by Sustainability Victoria.

All new assessments are to be undertaken in the latest version of the software. There may be some situations where an older version of software is acceptable; check the relevant state or territory regulations.

2b Software tools accredited under NatHERS, to which this handbook applies, are intended to be used for assessing new dwellings and major renovations where these renovations trigger NCC compliance for the dwelling. This includes Class 1, 2 or 4 buildings and attached Class 10a buildings.

Class 1, 2 or 4 dwellings are defined in the Building Code of Australia (BCA) Volumes One and Two of the National Construction Code (NCC) and can be modelled in software tools accredited under NatHERS. Class 10a buildings attached to Class 1, 2 or 4 dwellings must be modelled as part of the assessment. If a Class 10a building is not attached to the dwelling, it is to be modelled as a shading device.

Information about the NCC, building classification categories and specific state or territory requirements are available on the Australian Building Codes Board website: www.abcb.gov.au.

Software support is provided by the software tool providers:

- AccuRate: developed by CSIRO and provided by Energy Inspection
- BERS Pro: provided by Energy Inspection
- HERO: developed and provided by HERO Software
- FirstRate5: developed and provided by Sustainability Victoria.



2. BEFORE YOU START

2.2 Documentation

Assessors are to collect all information and documentation before starting the assessment. This will save time and ensure the project is fully understood before entering data into the software tool.

2c Minimum documentation required includes: (also see [Section 2.2.1](#) for more detail) (**Tech Note clause 2.5**):

- drawing set (site plan, floor plan, elevations and sections) with a true north point
- electrical schedule and appliance, solar panel, battery and pool specifications
- construction details
- window information; either an individual window and door size schedule or clearly noted floor plans or elevations showing the window operating type, height, head height, width and frame type, and skylight and roof window details.

2d If details in **2c** are not present on the drawing set or in the documentation, the drawing set or documentation must be clarified with the designer or client and the details added or amended except where default values apply. Prior to producing the final NatHERS Certificate, details on the drawing set and relevant schedules, addendums and specifications must align with the assessment. (**Tech Note clauses 3.3, 13.1**)

2.2.1 Drawings

The drawing set provides the basis of design documentation used for the assessment and is essential for certification (see **2c** and **2d**). The set of drawings must be drawn to scale and should include a version number and/or date. If the design documentation does not ensure clarity of information and readability, assessors are encouraged to request an improved standard of documentation. The set should include the items listed in [Table 2-1](#) at a minimum:

Table 2-1: Drawing set examples

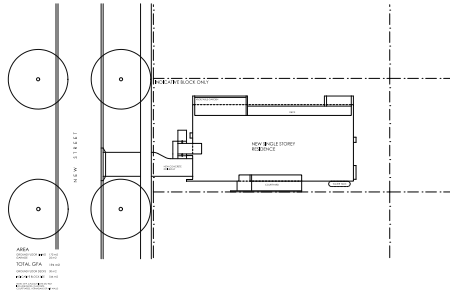
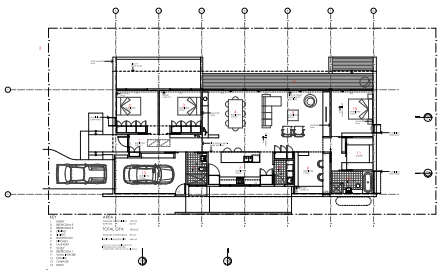
SITE PLAN		
<p>Minimum requirements include:</p> <ul style="list-style-type: none"> • north point indicating true north (See Chapter 4) • location postcode 	<p>Additional details may include:</p> <ul style="list-style-type: none"> • location of the dwelling in relation to the site • street address details • fences • contours • overshadowing structures such as adjacent buildings (see Chapter 10) • title boundary bearings 	
FLOOR PLAN/S		
<p>Minimum requirements include:</p> <ul style="list-style-type: none"> • room layout and room names or types • building and room dimensions • window and door locations • numbering of individual dwellings (for Class 2 buildings) 	<p>Additional details may include:</p> <ul style="list-style-type: none"> • window and door sizes • floor coverings • locations of ceiling penetrations such as exhaust fans and downlights • location of ceiling fans • shading structures such as eaves, pergolas and privacy screens 	

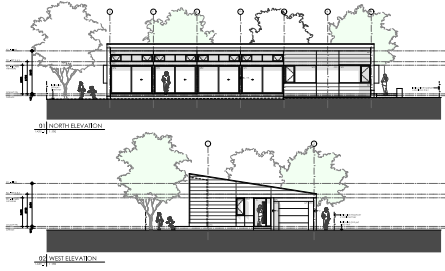
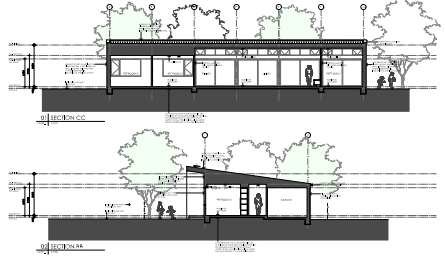

2. BEFORE YOU START

ELEVATIONS		
<p>Minimum requirements include:</p> <ul style="list-style-type: none">• window and door location, size and opening type• roof pitch, material and style• external wall materials	<p>Additional details may include:</p> <ul style="list-style-type: none">• external wall and roof colours• window openability and offset• shading structures such as eaves, pergolas and privacy screens• ground level/s, floor level/s and relative ceiling height/s	
SECTIONS		
<p>Minimum requirements include:</p> <ul style="list-style-type: none">• ground level/s, floor level/s and relative ceiling heights	<p>Additional details may include:</p> <ul style="list-style-type: none">• roof construction, materials and systems• location of insulation• subfloor construction• window head height• stair details	

Other information required as part of the design documentation to assist with the assessment may include but is not limited to:

- lighting location plan or electrical schedule, including details such as:
 - location of lighting
 - downlight or pendant type (light-emitting diode (LED), compact fluorescent light (CFL), fluorescent, etc)
 - location, type and size of ceiling or exhaust fans
 - specific insulation clearance and/or sealing details for ceiling penetrations.

If recessed light fittings information is not provided and the assessment is completed, the assessment assumes pendant lighting and it must clearly state on the NatHERS Certificate the dwelling has been assessed without downlights. If downlights are present in the dwelling, the assessment will need to be updated for compliance purposes (**Tech Note clauses 3.3 and 13.1**). This may not be required in New South Wales and Victoria; assessors should check if jurisdictional requirements prevail. (**Tech Note clause 1.5**)

- construction details:
 - of the construction components of the floor, subfloor, walls, ceiling and roof
 - information on insulation installation, floor coverings and finishes (including colours of roof, internal and external walls)
 - information and detailing of shading and overshadowing structures including neighbouring buildings.
- window and door schedule:
 - window and door types, including frame composition and opening style
 - windows and door sizes (sometimes shown as an abbreviated code on the floor plan; e.g. 1820 may refer to a window that is 1800mm width x 1200mm height)
 - glazing type and values
 - manufacturer name and window codes if specified.
- notes and other details, including:
 - all communication with the client that has been used to inform the assessment.



2. BEFORE YOU START

- 2e** If the drawing set and documentation is missing information, assessors must clarify the information. Where clarification has been sought but not received or is unknown an assessment must be undertaken using the default values in the NatHERS Technical Note (See [Section 2.3](#)).
- 2f** Where information is ambiguous or inconsistent, clarification must be sought from the designer or client and any appropriate revisions must be made to the design documentation before issuing the NatHERS Certificate. (**Tech Note clause 3.5**)

This includes where there is inconsistency between any of the documentation provided to conduct the assessment. Inconsistencies must be clarified with the client and the client needs to issue revised documentation and drawing sets before finalising the NatHERS Certificate, to ensure the rating aligns with the documentation.

2.3 Default settings

There are situations where assessors may not have the information or specific details to undertake a detailed assessment, either because decisions have not yet been made or information is not yet available. Default settings have been developed to be used in these situations (see also **2g** and **Tech Note clauses 3.8 and 3.9**).

Default values represent average practice (e.g. floor coverings) or worst-case option (e.g. roof colour).

A worst-case default value is where the documentation does not specify required details and a choice must be made by an assessor to represent the worst-performing option. Choosing the worst case as the default value means that if additional information becomes available and is changed in the assessment, the rating can only improve.

Where default values represent a worst-case scenario, assessors must test the choice to ensure the rating provided with the default value is the minimum that can be achieved. The correct identification of the worst-case default value may require multiple simulations because the outcome will be affected by other aspects of the assessment.

- 2g** Assessors must advise the client if default values are used and that some default values represent a worst-case scenario and the rating may be adversely affected.

Any default values used for the assessment must be detailed in the NatHERS Certificate 'additional notes.' (**Tech Note clauses 3.8 and 3.9**)

There are no NatHERS default values available for the average number and location of lights or ceiling penetrations within a dwelling; however, ratings can still be completed. In this case, the NatHERS Certificate will state that the dwelling has been rated without downlights or ceiling penetrations and clients should be told the dwelling will need to be rated again if these features are present.

2.4 Individual ratings

Dwelling designs are often repeated across projects. However, a wide range of features, such as the height, orientation, neighbouring obstructions and topography, will vary from dwelling to dwelling, which will change the rating.

- 2h** Every dwelling must have its own individual rating and NatHERS Certificate.

Every dwelling must have its own NatHERS certificate in accordance with the NatHERS Technical Note. This includes all Class 2 dwellings in a single building or development, even when a design is repeated on the same or different projects. The assessment and rating of each individual dwelling must reflect the individual characteristics of the dwelling modelled. (**Tech Note clauses 13.5 and 13.6**)

- 2i** Where a number of Class 2 multi-unit buildings are located in close physical proximity, as part of the same development or where the strata plan identifies separate lots, a summary certificate must be completed for each building/lot separately.



2. BEFORE YOU START

At the request of the client, a single Class 2 summary certificate can be produced for buildings that are combined and share structural elements (e.g. by a bridge, shared underground space or an enclosed walkway) where NCC requirements for combined buildings are met. (**Tech Note clause 13.6**)

2.4.1 Reusing a base file

Where dwellings are similar, assessors can build on an existing assessment file.

- **For an entirely different design:** a new NatHERS software file must be created for each project.
- **For a design that is similar to another assessment, with features that affect the result:** an existing base NatHERS software file could be duplicated and adjusted to accurately represent each dwelling's specific characteristics (e.g. height above ground, shading, orientation). This especially applies to multi-unit dwellings. For example, units in a multistorey building may have the same layout, but other conditions can vary such as the wind speed will increase and the height of a neighbouring obstruction will decrease further up the building.

If using a NatHERS software base file to duplicate units, remember to adjust the terrain exposure (see [Chapter 4](#)), orientation (see [Chapter 4](#)), height above ground (see [Chapter 6](#)) and shading from adjacent structures (see [Chapter 10](#)).

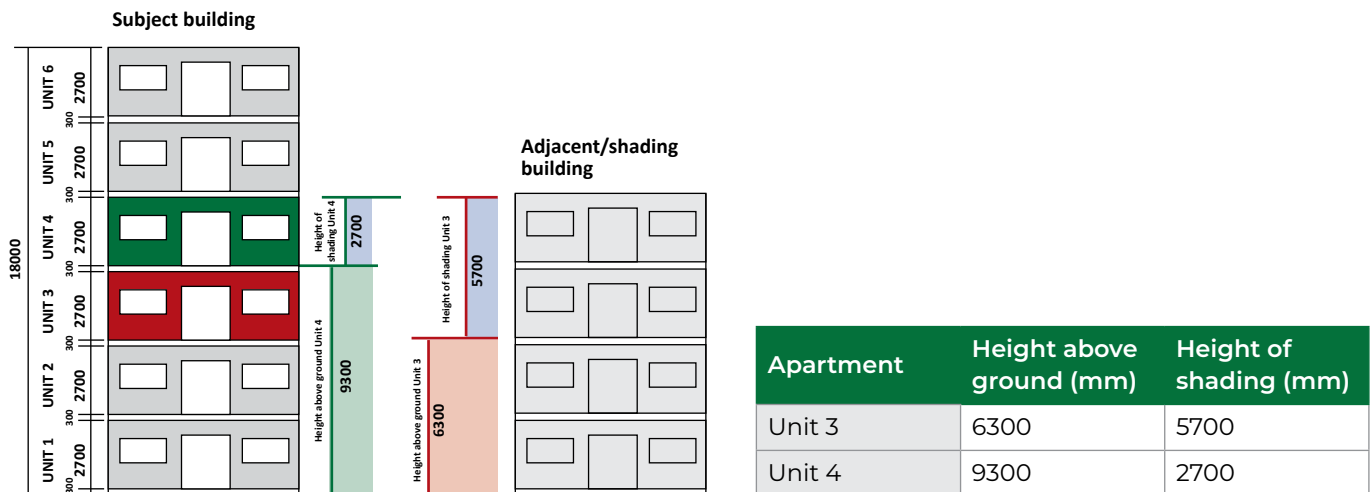

Figure 2-1: Considerations when duplicating base files for units

2.4.2 Modelling major renovations and building additions

A NatHERS assessment may be required for major renovations or additions. The requirements and definitions vary between jurisdictions and local councils; assessors should check the relevant jurisdictional regulations.

Different jurisdictions may also have different modelling methods to meet the requirement for the NCC energy efficiency requirements for additions. Assessors should refer to the NCC for jurisdictional variations and/or the relevant state or territory requirements in that specific area. (**Tech Note Introduction: Regulatory requirements**)

- 2j** NatHERS software tools must not be used to rate only part of a dwelling. Any rating for an addition to, or extension of, an existing dwelling must include both the existing and proposed areas of the dwelling.

Additions or extensions cannot be rated in isolation; they must be incorporated in a new rating for the entire dwelling. Class 10a structures are only to be included in the rating if they are attached to the dwelling. (**Tech Note clause 1.3**)



2. BEFORE YOU START

2k The drawing set and documentation must be retained by the assessor and produced if audited or quality assured.

All supporting information that informs an assessor's decision must be kept with the drawing set and documentation, and also be copied to the client so that it can be provided to the relevant building authority if required. (**Tech Note clause 3.10**)

2.5 Assessment goal

The assessment goal is the outcome the assessor needs to achieve to meet the client's requirements. When starting a project assessors must discuss with the client the state or territory requirements and the client's preferences.

The assessment goal may be:

- a regulatory goal for certification purposes:
 - to comply with the NCC
 - to comply with any state or territory building code requirements
- a particular star rating:
 - to meet a requirement set by the client, state or territory or other body
 - to provide information for a project or other purpose
- specific heating and cooling loads:
 - to meet a requirement set by the client, state or territory or other body
 - to provide information for a project or other purpose
- to provide the client with options:
 - to achieve jurisdiction compliance
 - to achieve better thermal efficiency
 - to reduce operating costs
 - to improve occupant comfort
 - to compare materials including glass, insulation and construction elements
 - to compare thermal bridging for steel frame construction
 - to compare construction methods such as cavity brick, brick veneer, lightweight construction, reverse brick veneer, etc.

2.6 Principles of thermal performance

Optimal thermal performance aims to keep the dwelling warm when it is cold outside and cool when it is hot outside. This is influenced by the climate zone where the dwelling is located; in colder climates the focus will be on keeping the dwelling warm while in warmer climates the focus will be on keeping the dwelling cool.

In adjusting the dwelling to meet a particular assessment goal, it is useful to think about some key principles of thermal performance (refer to the Your Home website for additional information: www.yourhome.gov.au). The following thermal performance principles should be considered to suit the particular climate zone and dwelling requirements of the client.



2. BEFORE YOU START

2.6.1 Maximise solar gain in cool months, minimise solar gain in hot months

Solar gain is heat transfer into the building that occurs because of solar radiation entering the dwelling. Controlling the effects of solar radiation on the dwelling means controlling how much of the sun's energy reaches the internal spaces of the dwelling.

Factors affecting solar gain include:

- **Orientation of the building:** Positioning the dwelling's orientation appropriately for the climate will enable best use of sunlight to heat the dwelling in cold climates and in colder months.
- **Window placement:** The placement of windows can affect the heat gains into and heat losses out of a dwelling. North-facing glazing can maximise solar gain in colder months and help to heat the dwelling. If coupled with thermal mass internally, north-facing windows can allow the sun in during the day to heat the mass, which allows the heat to be stored for release during the evening. There is however a balance with window placement; too much north-facing glazing can result in too much heat loss or – without appropriate shading – can result in too much heat gain.
- **Shading devices:** Shading can have a negative or positive effect on a dwelling. In some climates, particularly those dominated by cooler months, too much shading can prevent desirable solar gain, while in warmer climates adequate shading is essential all year round. The installation of adjustable shading devices is often the key to achieving different amounts of solar gain when needed throughout the year. Choosing tinted shading products suitable for the climate zone is also a way to achieve a more consistently comfortable dwelling.
- **External colour:** Darker colours absorb heat and lighter colours reflect heat. To assist with reducing indoor temperature extremes, it is preferable to use lighter and more reflective colours on the walls and roof. Some testing may be required to establish the optimum colour for the location and climate of the dwelling.
- **Insulation:** Insulation is key to maintaining thermal comfort as it ensures minimal heat escapes from the dwelling in cool temperatures and helps to retain cooler air inside in hot temperatures. To maximise these benefits, insulation should be paired with reducing opportunities for air leakage (e.g. minimising ceiling penetrations such as downlights and carefully sealing construction junctions).

2.6.2 Maximise or minimise energy transfer

Energy transfer is energy moving through the dwelling envelope because of conduction (where heat from a warm area moves through an element to a cold area). Conductive heat transfer occurs through walls (both external and internal), floors, roofs, glazing and skylights. Controlling energy transfer through a dwelling means controlling the insulating qualities and/or size of these various elements.

Factors affecting energy transfer include:

- **Dwelling shape:** Dwellings with less external wall area compared to the floor area of the dwelling have a smaller surface area through which energy can be transferred. Option A, B and C in [Figure 2-2](#) have the same floor area but the shapes give different surface areas of external wall. The wall surface area to floor area ratios are: Option A 0.73, Option B 0.87 and Option C 1.27. The greater the ratio, the greater the energy transfer.

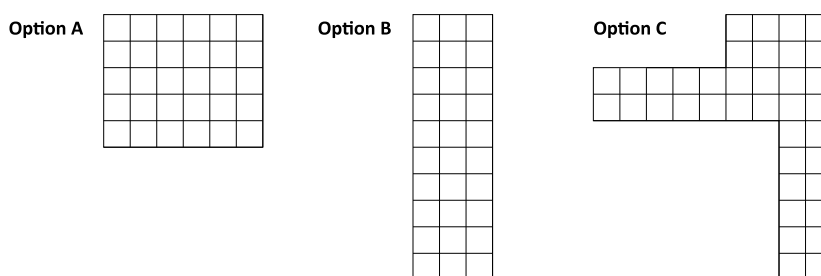

Figure 2-2: Minimising energy transfer through external surface area



2. BEFORE YOU START

- **Dwelling design:** Grouping similar zones together means the energy transfers between the internal walls are more likely to travel between like zones (see [Figure 2-3](#) below for more detail). When the assumed temperature profile is the same on either side of the wall, energy transfers are minimal. Minimising the surface area of internal walls and/or adding insulation between zones with differing temperature profiles (such as bedrooms and garages) will also minimise the amount of energy transfer.

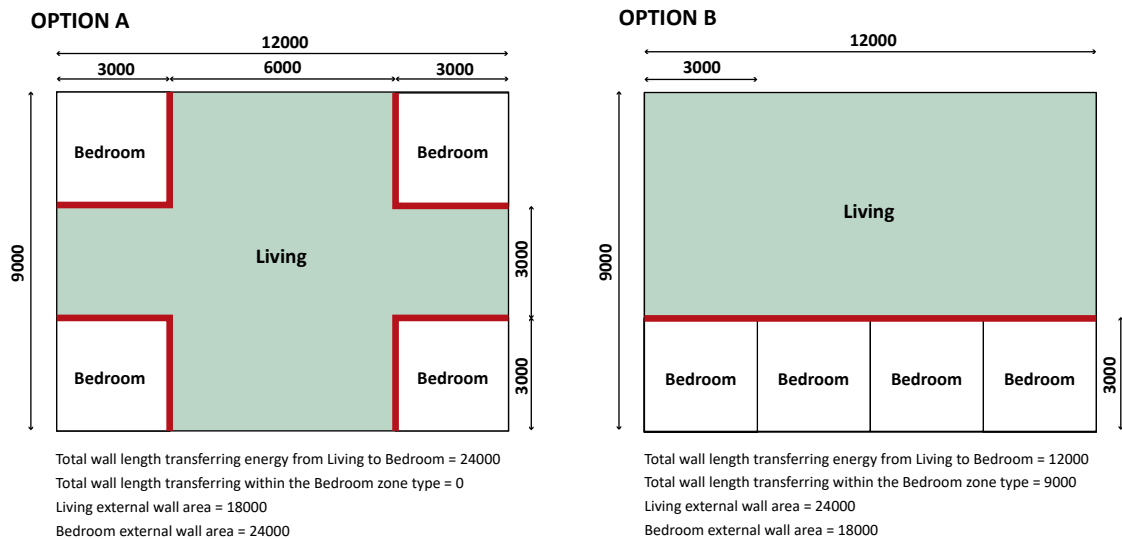

Figure 2-3: Minimising energy transfer through dwelling design

In Option A, the placement of bedrooms means that the total wall length between zones of differing temperature profiles (living and bedrooms) is 24000mm. In Option B, the new design achieves the same living space but the wall length between zones of differing temperature profiles is only 12000mm.

- **Window to conditioned floor area ratio:** Depending on climate zone, design and orientation, a high ratio can have a significant impact on the rating if the windows are the weakest point of energy transfer in the external wall. This depends on the window system (glass and frame) selected and other construction considerations.
- **Type and location of floor coverings:** Softer floor coverings (soft vinyl, floating timber and carpet) insulate the floor and may be desirable in some rooms in colder climates. However, north-facing living areas should leave the concrete slab exposed or use hard coverings (tiles, hard vinyl) for increased thermal gain; these can heat up during the day and release heat at night. A north-facing slab in a cool climate that is covered by carpet and underlay will have no thermal mass benefit. Harder floor coverings (tiles, polished concrete, hard vinyl) over a concrete-on-ground slab, allow the temperature of the ground and the mass of the concrete slab to be used to regulate the temperature of the dwelling. In hot climates, large expanses of hard floor coverings can help to moderate the temperature of the dwelling, provided adequate shading is installed to prevent the hard surfaces from heating up from direct sun. In cold climates, the ground temperature may be too cold and have too few sunlight hours to heat up at all. If this is the case, then waffle pod slabs, edge slab insulation and under-slab insulation could be considered. Approximately 80% of the heat loss from a concrete slab occurs through the slab edge. More information regarding this insulation option is available at www.yourhome.gov.au.
- **Materials and construction methods:** The selection of construction methods and materials is extremely important to the thermal comfort of a dwelling. Ensuring appropriate insulation is key to maintaining thermal comfort, as this will minimise heat loss from the dwelling in winter and retain cool air inside the dwelling in summer. Also, avoid ceiling penetrations or consider IC-4 rated downlights or similar to reduce compensation for air leakage and the negative impact to the effectiveness of the insulation.



2. BEFORE YOU START

- Increasing thermal mass internally to absorb and store heat energy can help to moderate the internal temperature of a dwelling. During hotter weather, it absorbs heat during the day and if the dwelling is vented overnight, the heat can be released to cooling breezes or clear night skies. In cooler weather, the same thermal mass can store the heat from the sun, or from heaters, and release the stored heat back into the dwelling, especially at night. A slab-on-ground design is usually an effective way of achieving consistent temperatures through the dwelling. Elevated floors, by contrast, are subject to changes in climatic conditions. Elevated floors may be useful in warmer climates where ventilation under the floor, coupled with the cooler shaded air, is beneficial to thermal comfort. In colder climates, enclosing the subfloor and placing insulation on the underside of the floor can help to re-establish stable temperatures under elevated floors.

2.6.3 Maximise ventilation and optimise infiltration

Ventilation is the movement of air by circulation or convection (e.g. through doors, windows, extraction fans). Infiltration is air movement due to the uncontrollable leakage (e.g. through construction gaps and/or unsealed penetrations). Controlling ventilation means controlling the potential air paths through a dwelling.

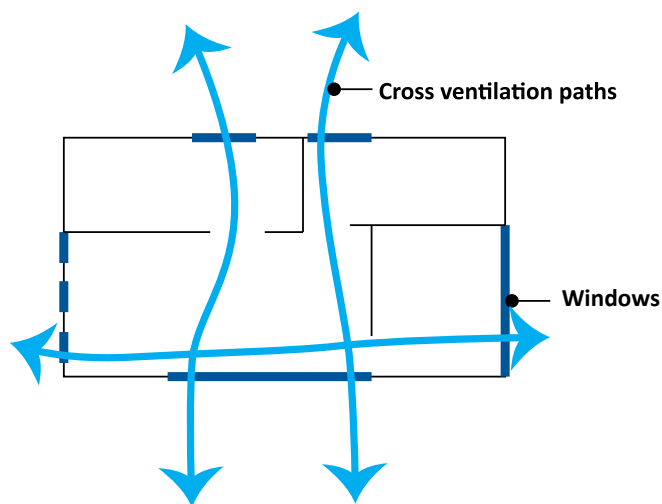

Figure 2-4: Cross ventilation

Factors affecting ventilation include:

- **Orientation of the dwelling:** Positioning the dwelling's orientation appropriately for the climate can make best use of prevailing winds to cool the dwelling.
- **Location of windows and doors:** Locating windows and doors opposite each other can allow a clear flow of air in and out of the dwelling. This cross ventilation (Figure 2-4) can passively help to cool the dwelling. The placement of internal doors and zoning of spaces can also ensure that heat within a particular space can be controlled; for example, ensuring the living areas can be closed off can help improve winter comfort and reduce energy bills as less energy will be needed to keep the room at a comfortable temperature.
- **Inclusion of downlights:** If unsealed, downlights can create an uncontrolled infiltration path from the rooms to the roof space, allowing warm or cool air in the room to escape into the roof space. In addition, downlights reduce the amount of ceiling insulation because a clearance area without ceiling insulation is generally required around the downlights for safety purposes. Assessors should consider specifying IC-4 rated downlights or similar to reduce compensation for loss of ceiling insulation.
- **Window type:** The opening type of a window or door affects its opening percentage and ventilation flow. For example, a single-pane casement window with a 90% opening percentage will provide more ventilation than a double-hung window as its opening percentage is only 45%. (See [Chapter 8](#)—Windows and doors)



3

Data entry and retention

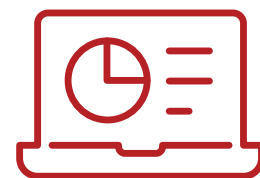

IN THIS CHAPTER

3.1	Project details	21
3.2	Scaling and measurement	21
3.3	Data retention	23

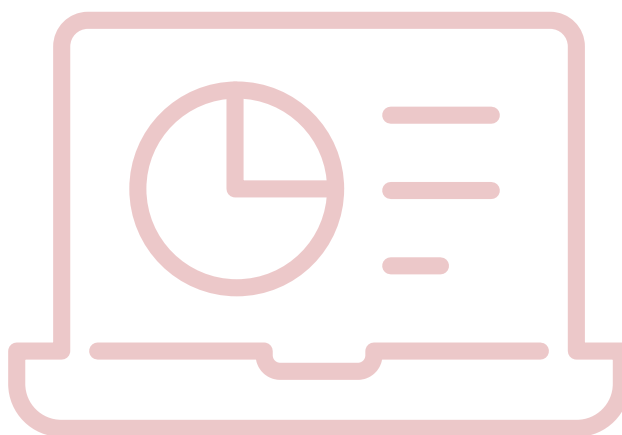

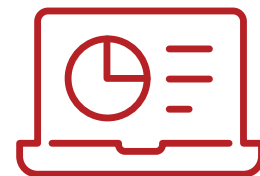

Assessors are to use a consistent, systematic approach when entering data into the NatHERS software tools to reduce errors and increase consistency and accuracy. Assessors should also check their work throughout the process.

Summary of data entry

A suggested approach for entering data into NatHERS assessment tools is:

1. Enter the project details ([Section 3.1](#)).
2. Enter the terrain and exposure (see [Chapter 4](#)).
3. Set the default settings and/or create, load or select the constructions to be used.
4. Scale the drawing canvas or plan tab and check that scaling is correct (this does not apply to non-graphical assessment tools) (see [Section 3.2](#)).
5. Zone the dwelling in accordance with the NatHERS Technical Note (see [Chapter 5](#)).
6. Adjust orientation appropriately (see [Chapter 4](#)).
7. Check the conditioning for each zone (see [Chapter 5](#)).
8. Enter or adjust the dwelling elements, including walls, windows and doors (see [Chapters 7 and 8](#)).
9. Enter or adjust the floors and ceilings, including floor coverings and under-floor insulation (see [Chapters 6 and 9](#)).
10. Check, enter or adjust the insulation details (see [Chapters 6, 7 and 9](#)).
11. Enter or adjust roofs and skylights (see [Chapter 9](#)).
12. Model thermal bridging for steel framed constructions (see [Chapter 11](#)).
13. Enter eave, overhangs, shading and overshadowing by adjacent dwellings and structures (see [Chapter 10](#)).
14. Simulate the project in the chosen NatHERS accredited software.
15. Correct any errors flagged by the assessment tool and re-simulate if applicable.
16. Use the dwelling and other reports to check the data.
17. Correct any errors.
18. Analyse and improve the assessment (see [Chapter 13](#)).
19. Check all documentation has been updated to reflect the final rating if changes have been made to optimise thermal performance.
20. Model fixed appliances, pools and spas, photovoltaic and battery storage systems to generate a Whole of Home rating (see [Chapter 12](#)).
21. Certify the assessment (see [Chapter 13](#)).

3. DATA ENTRY AND RETENTION

For further information, consult the assessment tool manuals, inbuilt and online help, FAQs or documentation issued by training organisations or Assessor Accrediting Organisations (AAOs).

3.1 Project details

Assessors are to complete the project details in the assessment tool accurately and include sufficient detail for every assessment. Project details are to be consistent with the dwelling documentation that is being used as the basis for the assessment.

3.2 Scaling and measurement

Assessors are to ensure the correct scaling is used in graphical assessment tools and that measurements from drawings being entered into assessment tools are accurate.

3.2.1 Scaling in graphical assessment tools

When using graphical assessment tools, before any data is entered it is important to take time with scaling as it forms the basis of all data entry. If the incorrect scaling is applied when the plan is imported, the rating will be incorrect as the length of walls (from the plan) and heights (entered by the assessor) will not align. It is also difficult to rescale or change data later in the assessment process if the scale is incorrect.

Assessors may be provided with a PDF of the dwelling or can create one using a scanner or from design software. To scale drawings in graphical assessment tools:

1. Follow the assessment tool manual to import or paste the image into the assessment tool.
2. Zoom in on the image and select the dimension to be used for scaling. Selecting a large dimension line will generally give the most accurate measurement for scaling.
3. Select the nodes at each end of the dimension (see the appropriate assessment tool manual).
4. Zoom the drawing or plan canvas in on the dimension to be used as the scale.
5. Using the measuring or scaling tools, enter the dimension into the assessment tool (more detail on how to do this should be available in the assessment tool manual).

To check dimensions:

6. Draw a zone of known size (it can be a real zone or a test zone that can be deleted after the dimensions have been checked).
7. Click on at least two walls of the chosen zone (it is best to use perpendicular walls) to ensure scaling is correct in all directions.
8. If incorrect, adjust by repeating steps 1 to 5.
9. If correct, begin to enter data.

These steps are general and assessment tool manuals may provide more specific instructions.

3.2.2 Measurements from drawings

Dimensions noted on drawings are to be used wherever possible. Where a dimension is not noted, use either a scale ruler or PDF software with a measuring function to obtain measurements. Take care to always use the correct scale for each drawing (e.g. a floor plan is usually 1:100, a site plan is usually 1:200).

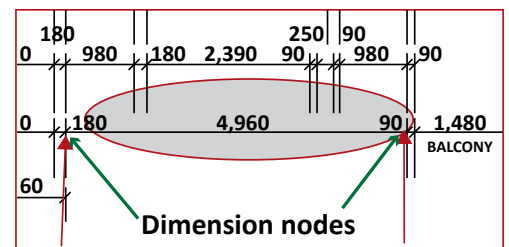

Figure 3-1: Scaling in graphic assessment tools



3. DATA ENTRY AND RETENTION

- **If using printed drawings:** Use a scale ruler to check the drawings are printed to scale by measuring a number of the dimensions in both directions because scanners can stretch images or the dimension text may have been altered. If the drawing is not to scale, assessors must either:
 - print a scale ruler to the correct scale or use techniques available on the internet, or
 - scan the drawings to make a PDF and use the PDF measuring method.
- **If using electronic and PDF drawings:** Use the PDF software scaling function to enter the scale of a drawing. Check the scale is correct by measuring a number of dimensions on the drawing. If the drawing is not to scale, adjust the scale (e.g. 1:100 might need to be 1:99) and then check the dimensions again. Repeat this until the scale is correct.

Assessors may also be able to export Computer-Aided-Drawings or PDFs into a computer program for measuring. If assessors are unsure of the drawing scale or have difficulty confirming dimensions, it is best practice to request clarity from the designer or client. See [Section 3.2.3](#) for help in calculating measurements for complex shapes.

3.2.3 Common area and volume calculations

The following common calculations may be used to obtain or verify measurements in the design documentation:

Area of a surface

$$A = h \times w$$

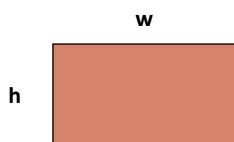

Area of a triangle

$$A = 1/2 bh$$

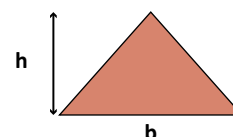

Area of a circle

$$A = \pi r^2$$

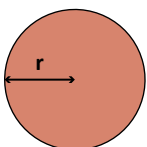

Area of a trapezoid

$$A = h \times \frac{(a+b)}{2}$$

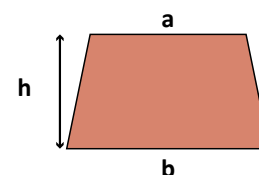

Area of a triangular prism

$$A = \frac{(w \times d \times h)}{2}$$

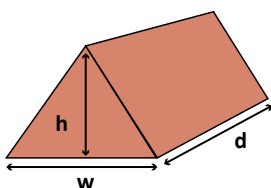

Area of a pyramid

$$A = 1/3h \times \text{base area}$$

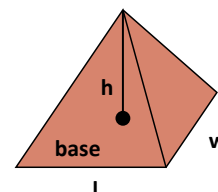

Volume of a room

$$V = l \times w \times h$$

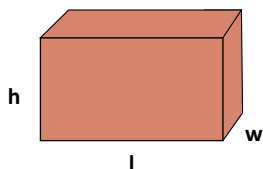

Volume of a pyramid

$$V = \frac{(l \times w \times h)}{3}$$

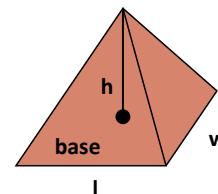

Volume of a prism

$$V = \text{area of base} \times \text{length or height}$$

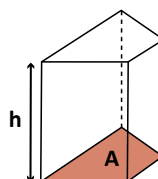
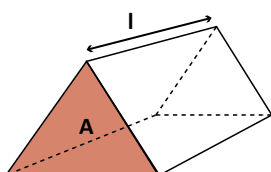

3. DATA ENTRY AND RETENTION

3.3 Data retention

The assessor must retain (for a minimum of seven years, or longer if required by the jurisdiction) all design, assessment and supporting documentation in line with the jurisdiction's requirements and for AAO and NatHERS review and quality assurance purposes. (**Tech Note clause 3.10**)



4

Climate, exposure, ground reflectance and orientation



IN THIS CHAPTER

4.1	Climate zone selection	25
4.2	Terrain and exposure	26
4.3	Orientation	28





The location of a dwelling in the environment significantly affects its thermal performance. NatHERS assessment tools take this into account by factoring in the climate zone, terrain exposure and orientation of a dwelling in the assessment.

Summary of key requirements

This handbook is intended to be a helpful resource for all assessors. When conducting assessments, assessors must follow the requirements of the current NatHERS Technical Note and the relevant state or territory requirements.

- 4a** The principal climate zone must always be used where there is no alternative climate zone for the subject location. Assessors should only use an alternative climate zone where justification is detailed in the 'additional notes' section of the NatHERS Certificate.
- 4b** Regulatory assessments must not be carried out with an incorrect postcode. The postcode used must represent the location of the dwelling.
- 4c** Assessors must use the exposure category best suited to the terrain surrounding the dwelling. To calculate the terrain exposure for an individual high-rise unit it is important to consider the height of the unit, as the exposure of multistorey dwellings generally increases with elevation. If an assessor is unsure whether the documentation is depicting true or magnetic north, assessors must clarify the direction of true north.
- 4d** Dwelling orientation is based on the rotation of the dwelling relative to true north, not magnetic north. If an assessor is unsure whether the documentation is depicting true or magnetic north, assessors must clarify the direction of true north.

4.1 Climate zone selection

NatHERS divides Australia into 69 different climate zones representing the varying climates across the country. Climate zones are generally aligned with postcode boundaries for convenience, except where there is likely to be a topographical or other feature within the postcode area that affects the local climate. In this situation, the assessment tool will offer alternative climate zone options for the postcode.

- 4a** The principal climate zone must always be used where there is no alternative climate zone for the subject location. Assessors should only use an alternative climate zone where justification is detailed in the 'additional notes' section of the NatHERS Certificate.

Assessor judgement is required where an alternative climate zone is given for a postcode. The selection of an alternative climate zone must be supported by justification detailed in the 'Additional Notes' section of the NatHERS Certificate. For example, if the subject site is in an elevated part of the postcode area not typical of the principal elevation of the given climate zone and the subject dwelling is located in an area more in line with the alternative climate zone. (**Tech Note clause 4.1**)



Figure 4-1: NatHERS climate zones

4b Regulatory assessments must not be carried out with an incorrect postcode. The postcode used must represent the location of the dwelling.

The postcode used must represent the location of the dwelling. If a newly developed suburb has not yet been allocated a postcode or the postcode is not available in NatHERS software tools, the postcode of the nearest existing suburb with similar climatic properties must be used; this must be detailed in the 'Additional Notes' section of the NatHERS Certificate. (**Tech Note clause 4.1**)

The NatHERS online climate zone map shows NatHERS climate zones: https://www.nathers.gov.au/themes/custom/govcms8_uikit_starter/climate-map/index.html. This map is for reference only and the NatHERS software tool selection of climate zones takes precedence.

4.2 Terrain and exposure

Exposure is defined as how open or protected the area surrounding a dwelling is. The exposure affects wind speeds and the dwelling's ability for air movement through ventilation and infiltration (air tightness) and thus can affect the temperature in a dwelling and its capacity to maintain heating/cooling loads. It is important to understand the different exposure types (see [Table 4-1](#)) as well as how to determine the exposure in multistorey dwellings (see [Section 4.2.1](#)).

4c Assessors must use the exposure category best suited to the terrain surrounding the dwelling. To calculate the terrain exposure for an individual high-rise unit it is important to consider the height of the unit, as the exposure of multistorey dwellings generally increases with elevation. If an assessor is unsure whether the documentation is depicting true or magnetic north, assessors must clarify the direction of true north.

The key features influencing wind pressure and speeds for a specific site and dwelling will generally include the following;





- Wind speed increases over or between hills, accelerates over open/flat areas of land or water and slows down over rougher topography.
- Adjacent buildings and vegetation decrease wind speeds at ground level when a dwelling is surrounded by taller buildings or vegetation but wind speed increases where it funnels around or between buildings.
- Wind speed and pressure increase with the height from the ground level. The higher the building, generally the more exposed it will also be to stronger winds, particularly where the building is taller than adjacent buildings and vegetation (see [Section 4.2.1](#)).

4. CLIMATE, EXPOSURE, GROUND REFLECTANCE AND ORIENTATION

A dwelling in a protected or suburban exposure category (i.e. surrounded by other buildings and/or trees) will usually encounter a slower wind speed and thus lower wind pressure than a building in an exposed or open category. The exposure category in NatHERS software tools affects predicted air movement through ventilation and infiltration.

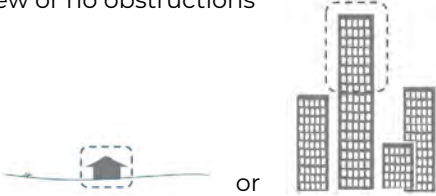
If the exposure does not fit easily into one of the four categories used in the NatHERS software tools, the assessor is encouraged to use the above information to assist in selecting the exposure category best suited to the terrain surrounding the dwelling based on the above information and assumed behaviour of prevailing winds (given the specific site information obtained). If the exposure is unclear, assessors are encouraged to use the site plan, site analysis (if available) and online maps including satellite and street view, to determine the terrain and exposure category.

Table 4-1: Terrain and exposure category guidance for single dwellings

Category	Terrain and built environment characteristics	Examples
Exposed	Few or no obstructions 	Flat grazing land, lakeside or ocean frontage, desert, exposed high-rise unit without obstructions at a similar height to the dwelling
Open	Grasslands with few well-scattered obstructions less than or equal to 10m high 	Farmland with scattered sheds, lightly vegetated bush blocks, elevated units with a few obstructions of similar height to the dwelling
Suburban	Numerous closely spaced obstructions less than or equal to 10m high 	Suburban housing, heavily vegetated bushland areas, townhouses
Protected	Numerous closely spaced obstructions greater than 10m high 	City and industrial areas

4. CLIMATE, EXPOSURE, GROUND REFLECTANCE AND ORIENTATION

4.2.1 Exposure in multistorey buildings

The terrain and exposure of Class 2 and 4 dwellings is determined by the height of the dwelling above ground and the height of surrounding obstructions.

To calculate the exposure for an individual high-rise dwelling it is important to consider the height of the specific dwelling above ground level. In many cases, lower-level dwellings will be more protected by surrounding buildings than a dwelling further up the building, so the exposure of multistorey dwellings generally increases with elevation.

For dwellings with higher elevation, assessors should first calculate the exposure for the entire building using the definitions in [Table 4-1](#). Assessors should then calculate the exposure of the individual dwelling. (**Tech Note clause 4.2**)

4.3 Orientation

Orientation is the positioning of a dwelling in relation to seasonal variations in the sun's path as well as prevailing wind patterns. Orientation, combined with the dwelling's location, design, construction, shading elements and the size and type of windows, all affect how the Chenath engine calculates solar heat gain and ventilation. These interactions, in turn, can greatly affect the star rating.

A fundamental passive solar design principle is that in dwellings south of the Tropic of Capricorn (see [Figure 4-2](#)) the living areas should be oriented so that the longest face is aligned as much as possible to north, to maximise winter sunshine and solar heat gain, and minimise solar radiation and heat gain in summer. A rectangular design that maximises exposure to winter sun is also often thought of as ideal.

Dwellings north of the Tropic of Capricorn, will receive sunshine from all directions at different times of the year and therefore northern orientation is generally less important than shading the dwelling from the sun all year round and from all sides, and capturing the prevailing breezes.

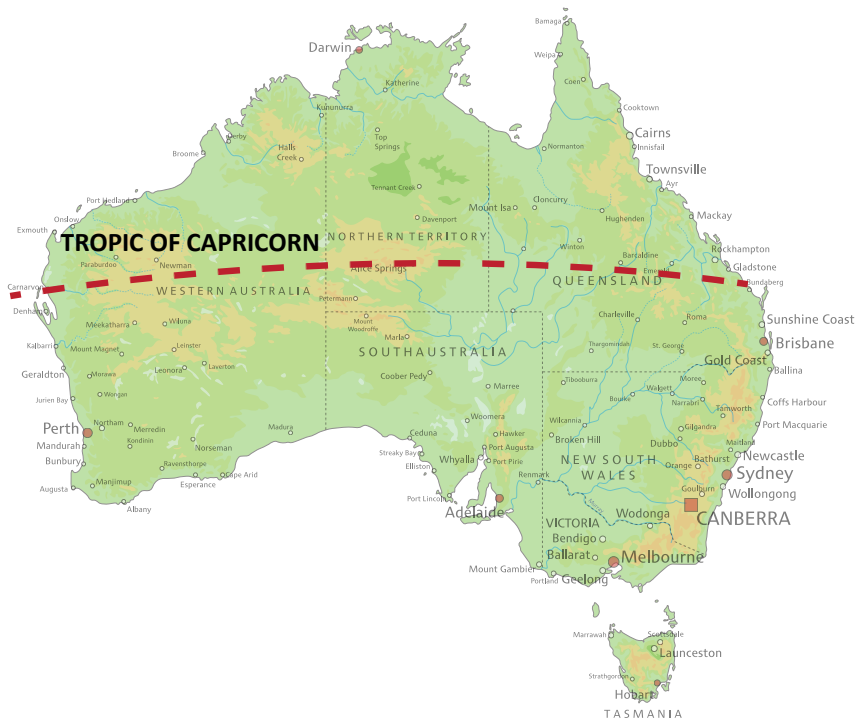

Figure 4-2: Tropic of Capricorn



4. CLIMATE, EXPOSURE, GROUND REFLECTANCE AND ORIENTATION

4.3.1 True north versus magnetic north

4d Dwelling orientation must be based on the rotation of the dwelling relative to true north, not magnetic north. (**Tech Note clause 4.4**). If an assessor is unsure whether the documentation is depicting true or magnetic north, assessors must clarify the direction of true north.

It is important to be aware of the difference between true north and magnetic north:

- **True north** is a constant direction based on the Earth's axis and is used in NatHERS software tools.
- **Magnetic north** is the direction from any point on Earth towards the Earth's magnetic north pole. As the magnetic pole continually moves over time, so does the direction of magnetic north.

The angular difference between true north and magnetic north is referred to as the angle of magnetic declination and varies with location and time. Plans and maps are generally drawn referencing true north and often include details on the magnetic declination in the area for a specified date.

The [Figure 4-3](#) below shows the declination angle in degrees for 2020 and the rate of change of declination in minutes-of-arc per year for the period 2010–20 for the Australian region.

For example, the magnetic declination of Sydney is $+12.66^\circ$ and Perth is -1.64° .

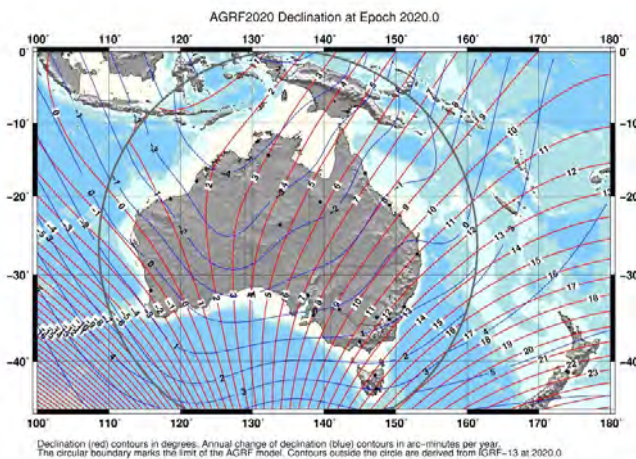

Figure 4-3: AGRF2020 Declination at Epoch 2020.0 (supplied by Geoscience Australia)

If the north point for a plot of land has been determined using a compass, it may be necessary to calculate the angle to correct for true north. To find the magnetic declination at a given location, visit Geoscience Australia's Australian Geomagnetic Reference Field model calculator: www.ga.gov.au/oracle/geomag/agrfform.jsp.

The best way to establish the orientation of a dwelling element, such as a wall or window, is to ensure that the bearings taken from the Certificate of Title are shown on the site plan. If the north point is unclear on any plans when assessing, it is recommended that assessors contact the client or surveyor for clarification. (**Tech Note clause 4.5**)

For further information on magnetic declination, see the Geoscience Australia's website: www.ga.gov.au/oracle/geomag/agrfform.jsp

For more information about orientation, see the relevant section of the Your Home website: www.yourhome.gov.au/passive-design/orientation



5

Zoning



IN THIS CHAPTER

5.1	Definition of a zone	32
5.2	Zoning the dwelling	34
5.3	Conditioning	37
5.4	Combining zones	38
5.5	Specific zoning scenarios	40
5.6	Floor and wall adjacency zones	48
5.7	Zoning ambiguous spaces	49

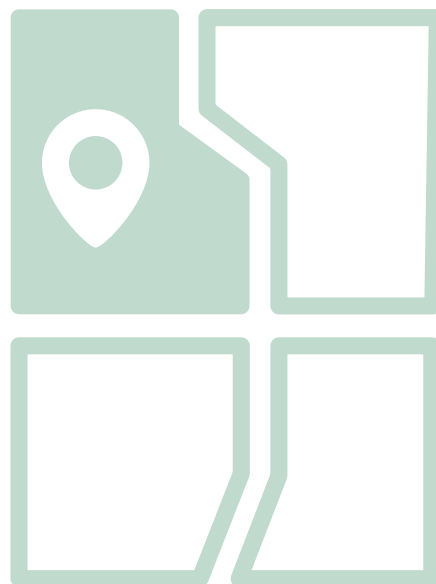



Zoning is one of the most important parts of the NatHERS data entry process and it is to be carried out as accurately as possible. The assumptions in the Chenath engine, coupled with the way the software models ventilation and airflow through a dwelling, can result in substantially different results if the zoning is incorrect.

Summary of key requirements

This handbook is intended to be a helpful resource for all assessors. When conducting assessments, assessors must follow the requirements of the current Technical Note and the relevant state or territory requirements.

- 5a** All parts within the dwelling envelope must be allocated or included in a zone. [Table 5-1](#) outlines software zoning types and definitions. This replicates Appendix 1 of the NatHERS Technical Note.
- 5b** The minimum zoning requirements for any dwelling are that:
- it must contain a minimum of three zones, excluding the garage (e.g. a kitchen/living, bedroom and unconditioned zone)
 - it must have at least one unconditioned zone
 - each zone must have walls, a floor and a ceiling and/or roof.
- 5c** Workshops, storerooms and laundries may be combined with the garage if they:
- are within the garage; and
 - can only be accessed from the garage and/or by an external door; and
 - do not contain an internal door to the dwelling (the garage can contain an internal door to the dwelling).
- 5d** A large number of zones can slow down calculations in Chenath. If the dwelling contains more than 50 zones, adjacent zones (e.g. bedrooms) may be combined if they:
- have external windows or doors to the same orientation; and
 - are the same zone type and conditioning; and
 - are open to the same internal zone (i.e. an internal hallway); and
 - do not have external ventilation to more than one orientation.
- 5e** Small non-habitable spaces such as small pantries (less than or equal to 700mm in depth), built-in robes, plumbing voids, wall voids and service ducts are included in the zone they are attached to or located in.
- 5f** Small storage spaces located under a staircase can be included in the same zone as the staircase.
- 5g** Ensuites or walk-in robes (WIRs) accessible only from a bedroom are considered night-time zones as they are more likely to have similar temperature settings and occupancy patterns to the bedroom. This is regardless of if the ensuite or WIR has a window, or if it is accessed via a door or a permanent opening.

5. ZONING

- 5h** An airlock, which is considered a small, relatively airtight space, may be modelled as an unconditioned space if it:
- is located at a dwelling entrance; and
 - has one or more external walls; and
 - has one or more internal walls; and
 - has an external door; and
 - has one or more internal doors, of which only one opens to a conditioned zone.
- 5i** Studios, bedsits and open-plan apartments must be modelled with at least three zones; kitchen/living, bedroom and unconditioned. When there are no obvious features by which to zone the open-plan studio or bedsit, the following minimum conditioned zone areas must apply (for modelling purposes only):
- kitchen/living zone area(s) = minimum of 30% of the total floor area
 - bedroom zone area = minimum of 20% of the total floor area
- These two zones shall be separated by an artificial plasterboard-on-stud internal dividing wall(s) with a wall area of no less than 40% between zones.
- 5j** Conditioned outdoor living areas (i.e. mechanically heated or cooled) must be considered within the dwelling envelope and assigned a zone when capable of being fully enclosed by solid construction elements (e.g. walls, windows, bi-fold or sliding doors).
- 5k** Outdoor living areas (enclosed or partially open), 'alfresco' spaces and detached garages are not allocated a zone and are an exception. These areas must be considered for shading purposes only.

5.1 Definition of a zone

A zone is defined as a space or group of spaces within a dwelling that have particular properties. Each zone type in NatHERS software tools ([Table 5-1](#)) has different inbuilt assumptions and thermostat settings based on the function of the room and how the different rooms within the dwelling will be used throughout the day (usage patterns). For example, the Chenath engine assumes night-time zones are heated and cooled to different temperatures at different times compared to living zones, and that cooking, occupancy and lighting at certain times of the day will affect heat loads.

To ensure an assessment is accurate, every space in a dwelling that is physically separated from other spaces with walls should be a separate zone. An exception to this is if the space is considered a small air space, in which case it may be combined with the zone it is entered from or attached to (see [Section 5.5.2](#)), or if the specific parameters for combining zones are successfully met (See [Section 5.4](#)).

Studios, bedsits and open-plan apartments can be artificially divided if required, to achieve at least three zones (see [Section 5.5.6](#)). (**Tech Note clause 5.3**)

In some jurisdictions, different zoning rules take precedence over the NatHERS zoning rules. To find more information about specific jurisdictional requirements, visit the Australian Building Codes Board website: www.abcb.gov.au/ABCB/State-and-Territory-Building-Administrations.



5. ZONING

Table 5-1: NatHERS Software tool zone type definitions (Appendix 1 of the NatHERS Technical Note)

Spaces/areas Ventilated: has a door and or an openable window on an external wall Unventilated: has neither an openable window nor door on an external wall	Zones										
	Classes 1, 2 and 4									Class 2 or 4 only	
	Kitchen / living ¹	Living ²	Daytime	Bedroom	Night-time	Unconditioned ³	Refer to the parent zone ⁴	Garage – unconditioned	Garage – conditioned	Glazed common area	Shared basement carpark
Airlock ⁵			•			•					
Bathroom ⁶ , unventilated – see also ensuite							•				
Bathroom ⁶ , ventilated – see also ensuite						•					
Bathroom with in-floor heating ventilated or unventilated					•						
Bedroom											
Cellar, conditioned			•								
Cellar, unconditioned						•					
Corridor within dwelling, fully enclosed by doors or open to other zones			•								
Corridor, public, unconditioned, glazed										•	
Dining room ²		•	•								
Ensuite, ventilated or unventilated – see also bathroom		•		•	• ⁷	• ⁸	• ⁹				
Family room ²		•	•								
Garage, conditioned								•			
Garage, unconditioned											
Gym			•								
Hallway, fully enclosed by doors or open to other zones			•								
Hallway, solely associated with a bedroom that can be closed off from the main dwelling ¹					•						
Kitchen (main) with or without meals/lounge/living/dining	•										
Kitchen (second)/kitchenette		•									
Laundry, unventilated							•				
Laundry, ventilated with door to another zone						•					
Laundry, ventilated open to another zone							•				
Lift			•								
Living ²		•	•								
Lounge ²		•	•								
Media ²		•	•								
Outdoor living area, capable of being fully enclosed, conditioned			•								
Pantry, not walk-in							•				
Pantry, walk-in			•								
Parent's retreat					•						
Pool room			•								
Powder room, unventilated							•				
Powder room, ventilated						•					
Rumpus ²		•	•								
Sauna			•								
Shared basement carpark enclosed											•
Storage							•				
Storage under staircase							•				
Study or office with either built-in wardrobe, WIR or ensuite					•						
Study or office without either built-in wardrobe, WIR or ensuite			•								
Theatre, library, prayer room ²		•	•								
VOIDS e.g. wall, plumbing, service ducts							•				
Walk-in-robe (WIR)					•						
WC, unventilated							•				
WC, ventilated						•					

- All dwellings must contain only one main kitchen/living zone. All additional smaller kitchens/kitchenettes within the dwelling must be zoned as "living".
- If there are more than two living areas (excluding kitchen/living), then:
 - the two largest living areas are zoned as "living"; and
 - the other areas are zoned as "daytime".
- Every dwelling must have at least one unconditioned zone. If no rooms fit the definition of "unconditioned", then assessors must choose the smallest zone and model this as "unconditioned".
- The parent zone is the larger zone that the smaller space is accessed from (e.g. if the parent zone is a kitchen/living zone) then assessors must default to "daytime".
- An airlock must have:
 - an external door and or openable window on an external wall and
 - one or more internal doors, of which, only one opens to a conditioned zone. If it does not meet these two criteria it must be zoned as "daytime".
- All dwellings must have at least one main bathroom and one main WC that are available for general household use (these may be combined or separate rooms).
- A secondary bathroom and/or WC (either ventilated or unventilated) that is exclusively associated with one or more bedrooms.
- A secondary bathroom and/or WC with a two-way entry and ventilated.
- A secondary bathroom and/or WC with a two-way entry and not ventilated.



5. ZONING

As briefly mentioned above, these zone descriptions are based on the Chenath engine assumptions and thermostat settings based on the main purpose of the room and the usage patterns of how the rooms within the dwelling will be used throughout the day. For example, the Chenath engine assumes that bedroom zones are heated and cooled to different temperatures at different times to living zones and that cooking at certain times of the day will add heat to the kitchen.

If after consulting [Table 5-1](#) it is still unclear which zone type to use for a particular space, assessors may want to consider how the space is heated/cooled and how often and when it may be primarily occupied, to assist in making a decision, or contact their AAO for further advice.

[Table 5-2](#) provides a summary of total sensible and latent heat load assumptions that differ depending on the zone type, including considerations of heat obtained through appliances and cooking, lighting and occupancy. The values in [Table 5-2](#) are based on a 160m² dwelling with two adults and two children, with a floor area split of 80m² for all the living areas and 80m² for all the bedroom areas. More detailed information of these assumptions, heat gains and thermostat settings can be found at Chenath repository at <https://hstar.com.au/Home/Chenath>

Table 5-2: Summary of Chenath assumptions for internal heat gains

Time	Total heat loads (Watts)		
	Living space with kitchen	Living space without kitchen	Bedroom
Midnight–7am	100	0	300
7am–8am	1260	600	0
8am–9am	760	600	0
9am–5pm	340	210	0
5pm–6pm	760	615	0
6pm–7pm	2360	615	0
7pm–10pm	910	615	100
10pm–Midnight	100	0	300

5.2 Zoning the dwelling

A number of zoning requirements must be met when conducting NatHERS assessments. These take into account the various assumptions mentioned in [Section 5.1](#) of how the rooms within the dwelling will be used throughout the day. Depending on the software tool, zoning may be defined by the room floor area or may include internal walls within the zone boundary.

5a All parts within the dwelling envelope must be allocated or included in a zone. [Table 5-1](#) outlines software zoning types and definitions. This replicates Appendix 1 of the NatHERS Technical Note. (**Tech Note clause 5.1**)

Assessors must assign zones to all parts of the dwelling that can be fully enclosed by the dwelling envelope, which is defined for NatHERS purposes as the physical separator between the dwelling being assessed and the outside environment or neighbour. The dwelling envelope comprises a dwelling's walls/windows/doors, ceilings, roofs and floors, and includes the resistance to air, water, heat, light and noise transfer. [Figures 5-1](#), [5-2](#) and [5-3](#) provide zoning examples of two dwellings.

When modelling in NatHERS software tools, the dwelling envelope includes both conditioned and unconditioned zones. This is different to the NCC definition of a building/thermal envelope, which is defined as the building's fabric that separates artificially heated and cooled spaces from the exterior of the building or other spaces that are not artificially heated or cooled. Zones of the same type cannot be combined unless the parameters outlined in [Section 5.4](#) are met. (**Tech Note clause 5.4**)



5. ZONING

For NatHERS modelling purposes, all dwellings must contain a minimum of three zones, including an unconditioned zone excluding the garage. All dwellings must also contain only one main kitchen area zone, with all other smaller kitchens or kitchenettes within the building being zoned as daytime. There is to be a maximum of two living areas, which must be the two largest living areas, with all other living areas being zoned as daytime. These requirements are just a few of the principles outlined in more detail in [Table 5-1](#). (**Tech Note Appendix 1**)

5b The minimum zoning requirements for any dwelling are that:

- it must contain a minimum of three zones, excluding the garage. For example, a kitchen/living, bedroom and an unconditioned zone
- it must have at least one unconditioned zone
- each zone must have walls, a floor and a ceiling and/or roof. (**Tech Note clause 5.2**)



Figure 5-1: Example single-storey dwelling zoning

5. ZONING

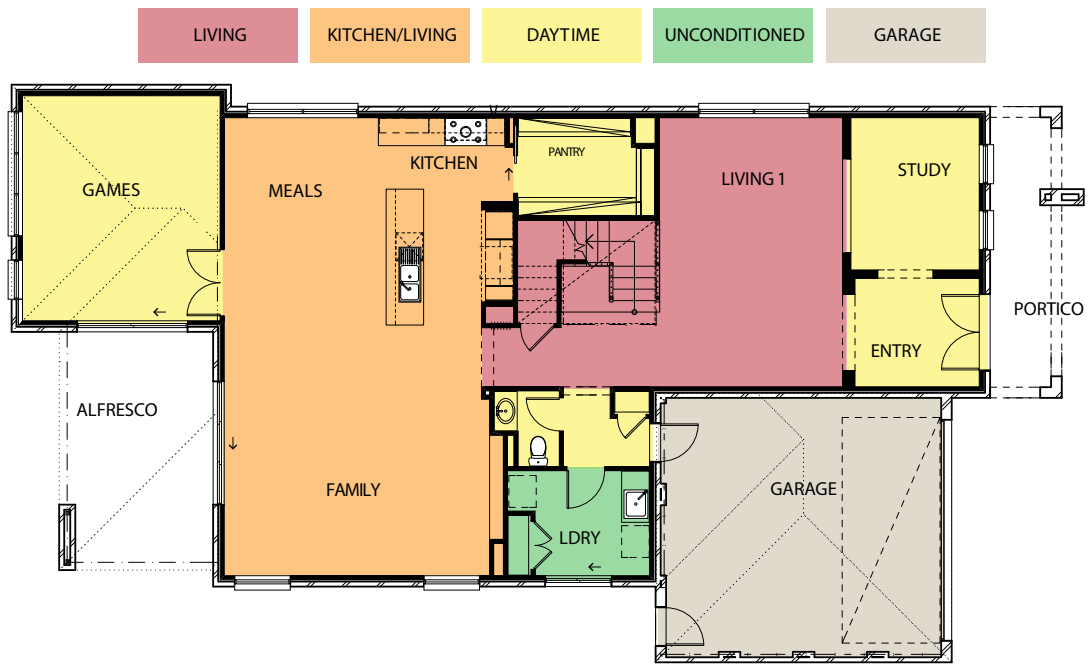

Figure 5-2: Example double-storey dwelling zoning – downstairs

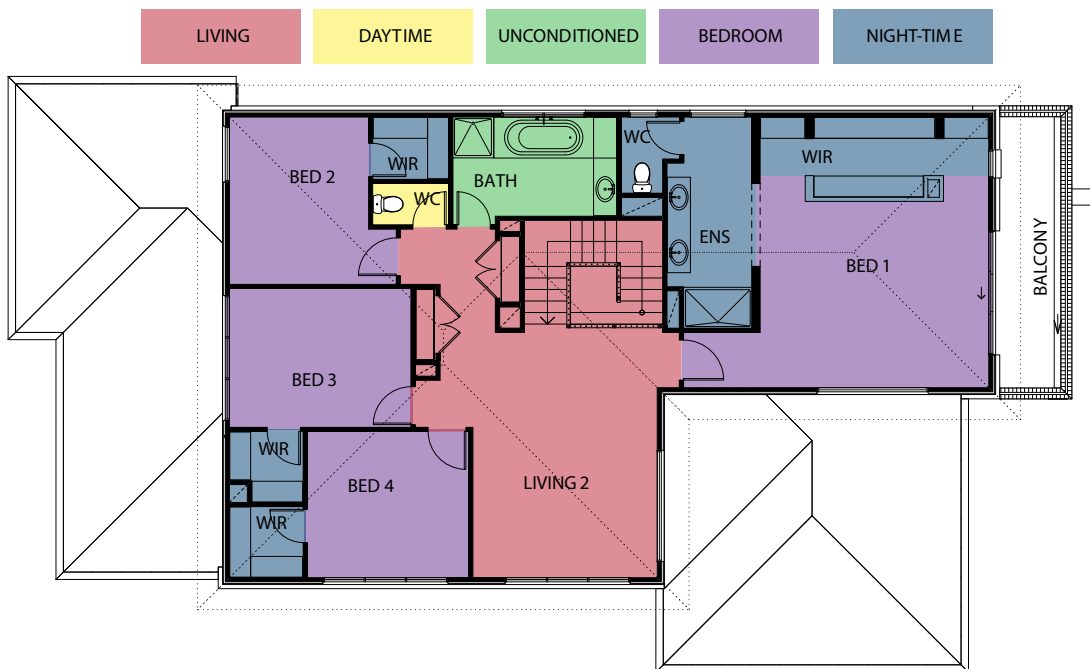

Figure 5-3: Example double-storey dwelling zoning – upstairs

5. ZONING

5.3 Conditioning

Each zone is considered to be 'conditioned' or 'unconditioned' (see Table 5-1).

Assessors must ensure the correct terminology is used when referring to conditioned and unconditioned zones, and to heated and cooled zones. The terminology has slightly different meanings in different scenarios (i.e. NatHERS, BASIX or the NCC). The words may also be used with a different meaning by different sectors of the building industry, or different state and territory governments.

In NatHERS, 'conditioning' relates to room purpose and the assumptions around usage patterns for that room. When allocating zone type it does not refer to heating and cooling appliances. Most spaces within the building envelope are considered to be conditioned, except bathrooms, WCs, laundries which have an opening to the outside, and garages (see Table 5-1).

- **Conditioned:** an area that is considered to be artificially heated and/or cooled when assessed using NatHERS software tools.

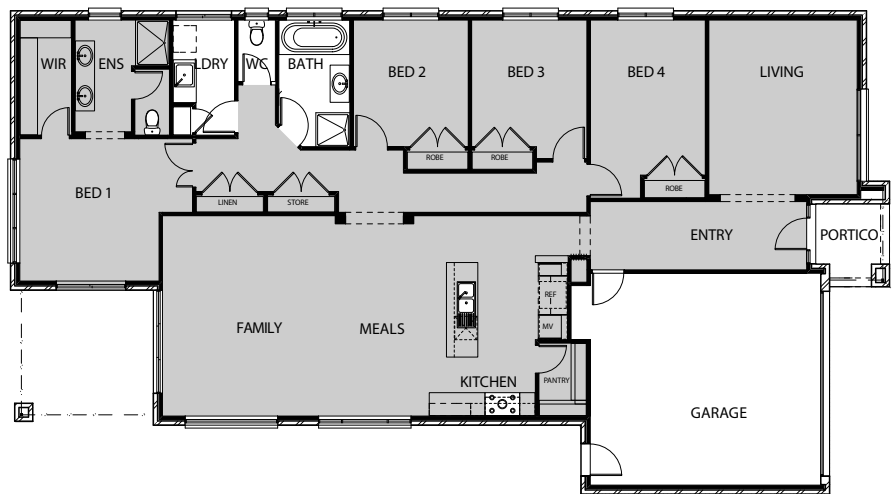

Figure 5-4: Conditioned zones of example dwelling

- **Unconditioned:** an area that is not considered to be artificially heated and/or cooled at all when assessed using NatHERS software tools.

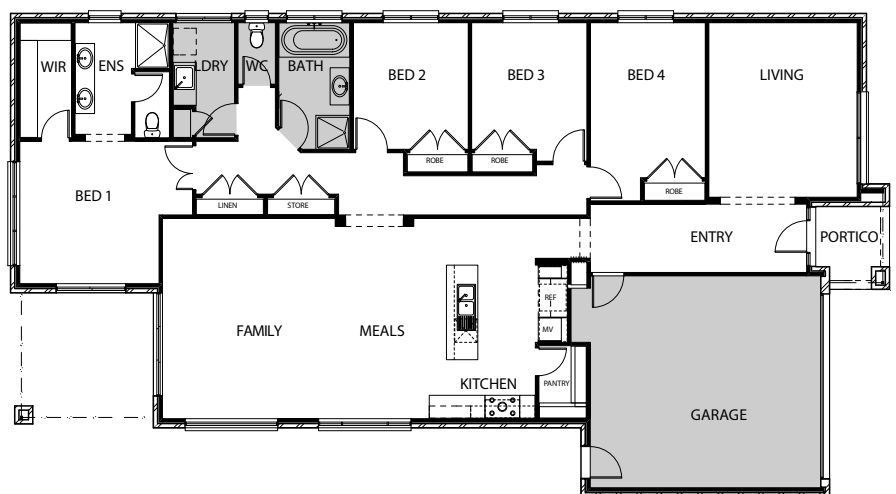

Figure 5-5: Unconditioned zones of example dwelling

5. ZONING

5.4 Combining zones

The accuracy of a rating improves as the number of zones increase. Zones must not be combined, even when the zoning types are the same. In [Figure 5-6](#) for example, even though the laundry, WC and bathroom are all unconditioned zones they must be zoned separately and not as one combined zone.

There are only two circumstances where zones may be combined, other than small air spaces (see [Section 5.5.2](#)).

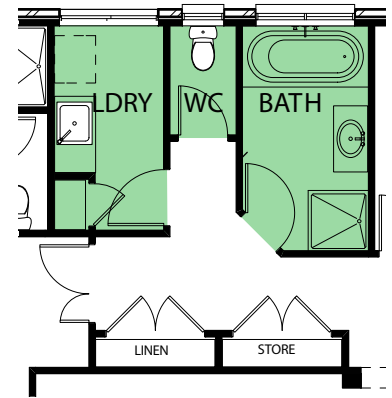

Figure 5-6: Zoning rooms separately

5c Workshops, storerooms and laundries may be combined with the garage if they:

- are within the garage; and
- can only be accessed from the garage and/or by an external door; and
- do not contain an internal door to the dwelling (the garage can contain an internal door to the dwelling).
(**Tech Note clause 5.4**)

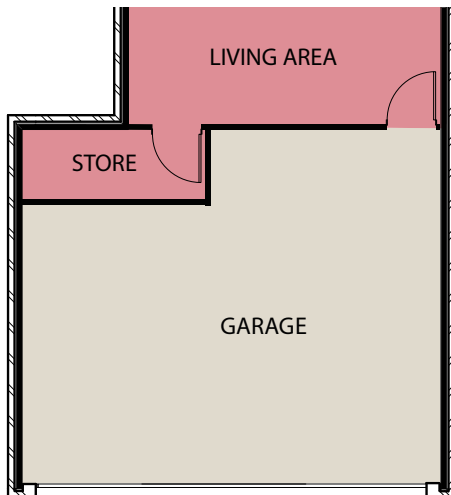

Figure 5-7: Storeroom modelled as small air space in living zone

In [Figure 5-7](#), the storeroom cannot be zoned combined with the garage as it is accessible from the living zone. In this instance, the storeroom is considered a small air space (see [Section 5.5.2](#)) and is modelled included in the living zone.

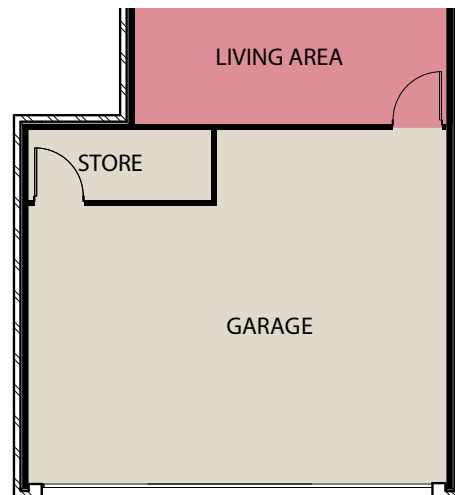

Figure 5-8: Storeroom modelled as combined with garage zone

[Figure 5-8](#) shows the storeroom and garage as one combined zone. The storeroom may be combined with the garage as it is within the garage and only accessible from the garage.

5. ZONING

5d A large number of zones can slow down calculations in Chenath. If the dwelling contains more than 50 zones, adjacent zones (e.g. bedrooms) may be combined if they:

- have external windows or doors to the same orientation; and
- are the same zone type and conditioning; and
- are open to the same internal zone (i.e. an internal hallway); and
- do not have external ventilation to more than one orientation. (**Tech Note 5.4**)

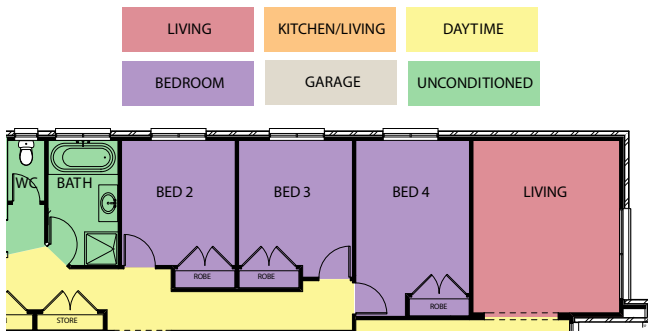

Figure 5-9: Example of combining zones of the same type when dwelling has more than 50 zones

If the dwelling in [Figure 5-9](#) has more than 50 zones, bedrooms 2, 3 and 4 can be combined as one zone. This is because all the bedrooms are the same zone type, are open to the same zone (hallway), and all external windows are facing the same orientation.

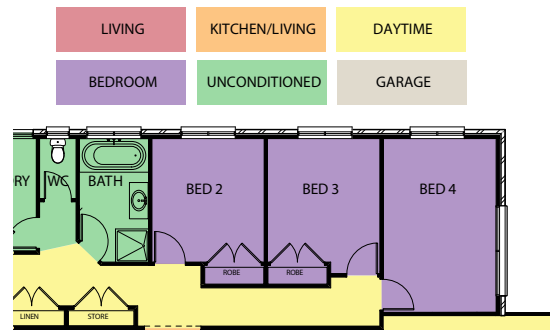

Figure 5-10: Example where only bed 2 and 3 can be combined when dwelling has more than 50 zones

If the dwelling in [Figure 5-10](#) has more than 50 zones, only bedrooms 2 and 3 can be combined as one zone. Although all the bedrooms are the same zone type and are open to the same zone (hallway), bedroom 4 cannot be combined as it has a window to a different orientation.

5. ZONING

5.5 Specific zoning scenarios

The following section provides guidance about specific zoning scenarios that may occur.

5.5.1 Stairwells

Depending on where a stairwell is located in a zone, it can be treated either as part of an existing zone or its own zone. The design documentation should contain details of the stairwell. Where this information is not available, assessors are to contact the client for more information.

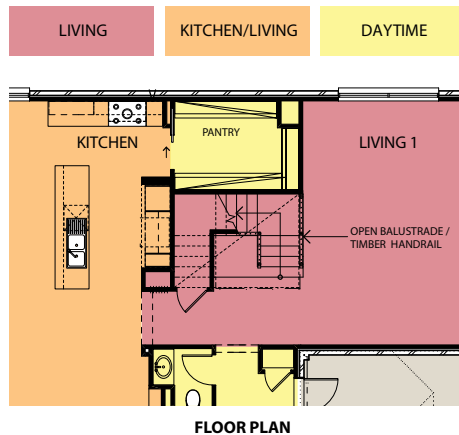

Figure 5-11: Example of stairwell with open balustrade – zoning combined

The stairwell in [Figure 5-11](#) has exposed stringers and an open balustrade. Although the hallway area of the stairs is open to the living zone, because there is no permanent boundary between the stairwell itself and the living zone the stairwell is included in the living zone.

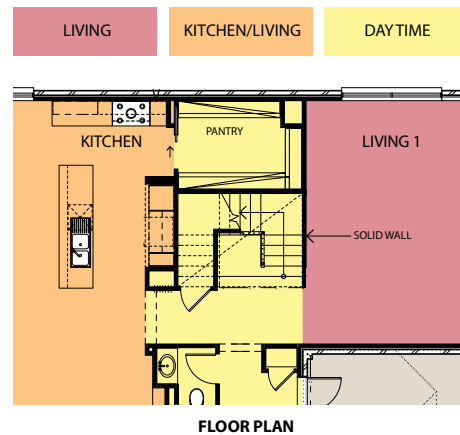

Figure 5-12: Example of stairwell partly divided by wall – zoning separate

The stairwell in [Figure 5-12](#) is separated from the living zone by a wall. Although the hallway area remains open to the living zone, because there is predominantly a permanent boundary (solid wall) between the stairwell itself and the living zone the stairwell becomes a separate daytime zone.

5.5.2 Small spaces

As a general rule, a small non-habitable space is a space that is not large enough to walk into (i.e. less than or equal to 700mm in depth). Where a cupboard or other space is bigger than this, it will become its own zone (see [Section 5.5.3](#)).

- 5e** Small non-habitable spaces such as small pantries (less than or equal to 700mm in depth), built-in robes, plumbing voids, wall voids and service ducts are included in the zone they are attached to or located in. **(Tech Note Appendix 1)**
- 5f** Small storage spaces located under a staircase can be included in the same zone as the staircase. **(Tech Note Appendix 1)**

As these small storage spaces do not usually contain ventilation they will have the same conditioning as the zone they are attached to. Powder rooms and WCs are not classified as small air spaces (predominantly because of ventilation assumptions) and must be zoned accordingly.

The treatment of small air spaces may vary between jurisdictions. To find more information about specific jurisdictional requirements, visit the Australian Building Codes Board website: www.abcb.gov.au/ABCB/State-and-Territory-Building-Administrations.

[Figure 5-13](#) gives some examples of small spaces and the correct zoning and modelling guidance.



5. ZONING

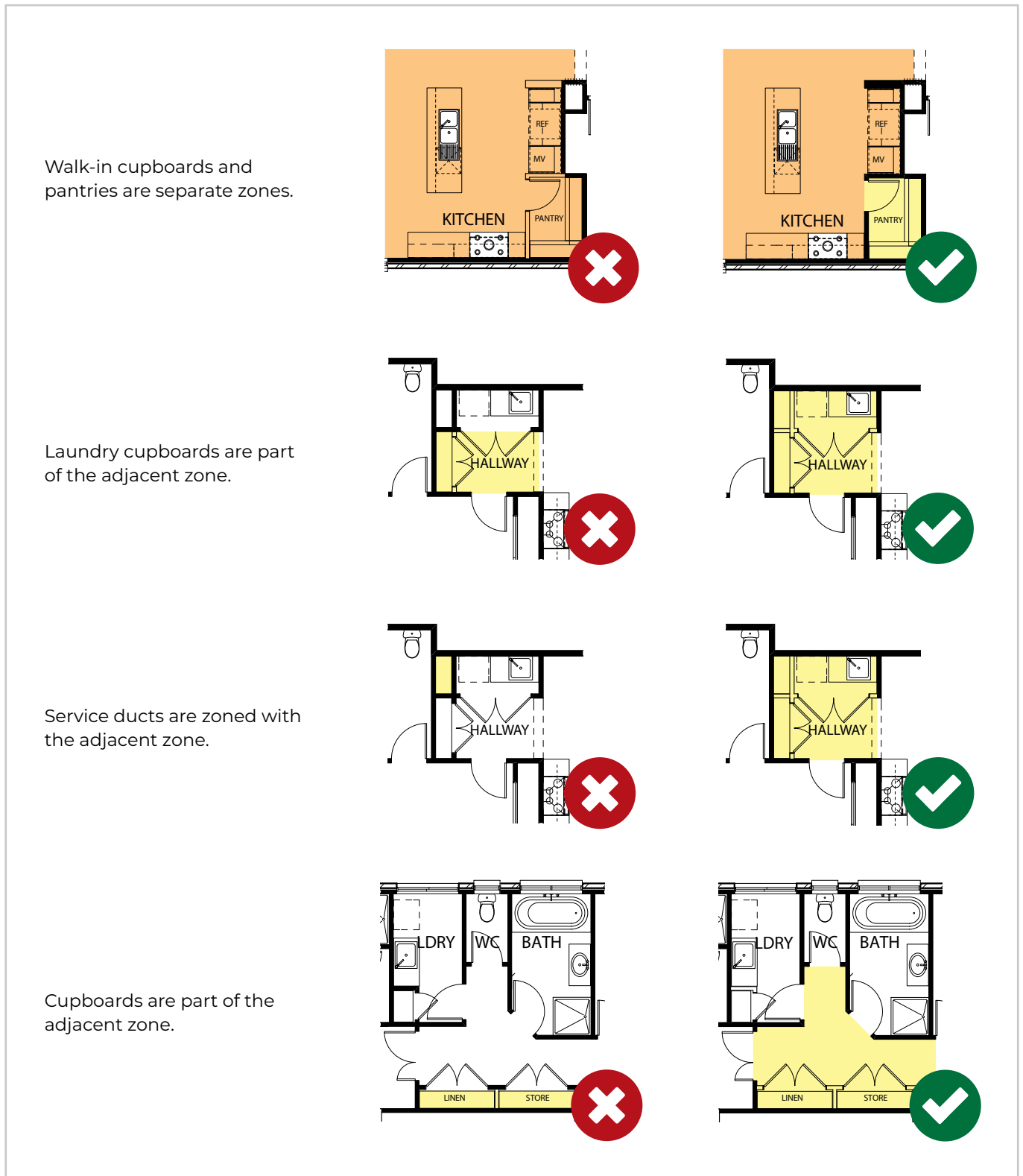

Figure 5-13: Zoning small spaces



5. ZONING

5.5.3 Ensuites, walk-in robes and cupboards

Ensuites, walk-in robes (WIRs) and cupboards large enough for a person to walk into (greater than 700mm in depth) must be modelled as individual zones, regardless of whether they have a ventilation opening. Cupboards or storage that cannot be walked into are considered small air spaces and to be included in the zone they are accessed from (see [Section 5.5.2](#)). However, in the case of studios, bed-sits and open-plan apartments there may be an acceptable exception to this requirement as outlined in [Section 5.5.6](#).

5g Ensuites or WIRs accessible only from a bedroom are considered night-time zones as they are more likely to have similar temperature settings and occupancy patterns to the bedroom. This is regardless of if the ensuite or WIR has a window, or if it is accessed via a door or a permanent opening. (**Tech Note Appendix 1**)

In [Figure 5-14](#) the WIR, ensuite and WC are each zoned separately. The WIR and ensuite are only accessed from the bedroom, therefore they are both zoned as night-time. The WC is accessed only from a night-time zone and therefore assumes the same zoning (night-time).



Figure 5-14: Zoning for ensuites, WIRs and WCs

5. ZONING

5.5.4 Parent's retreats and similar walk-in robes

A parent's retreat or walk-in robe (WIR) can be either a daytime or night-time zone, depending on how the zone is accessed:

- If a person must travel through the parent's retreat or WIR to access the bedroom from a kitchen, living or daytime zone (or other space with similar features), the space is zoned as daytime.
- If the only access to the parent's retreat or WIR is through the bedroom, the space is zoned as night-time. (See [Section 5.5.3](#))

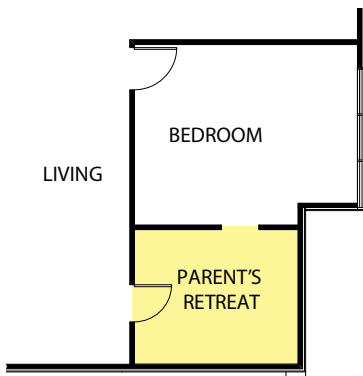

Figure 5-15: Daytime zoning – accessible from a conditioned zone

The parent's retreat in [Figure 5-15](#) is zoned daytime as it is accessible from a kitchen, living or daytime conditioned zone (living).

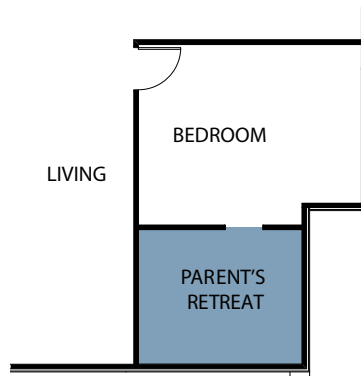

Figure 5-16: Night-time zoning – only accessible from a night-time zone

The parent's retreat in [Figure 5-16](#) is zoned night-time as it is only accessible from a night-time zone (bedroom).



Figure 5-17: Daytime zoning – WIR accessible from a conditioned zone

The WIR in [Figure 5-17](#) is zoned daytime as it is accessible from a kitchen, living or daytime conditioned zone (living).

5.5.5 Airlocks

An airlock is defined as a small, relatively airtight space that is not a hallway. An airlock is a space that separates the outside from conditioned zones (e.g. a boot/mud room). An airlock can be zoned as an unconditioned space if it meets all of the following defined requirements.

- 5h** An airlock, which is considered a small, relatively airtight space, may be modelled as an unconditioned space if it:
- is located at a dwelling entrance; and
 - has one or more external walls; and
 - has one or more internal walls; and
 - has an external door; and
 - has one or more internal doors, of which only one opens to a conditioned zone. (**Tech Note Appendix 1**)

Some airlocks shown on plans are not genuine airlocks (i.e. airtight spaces). A space that can be used to access two conditioned zones will function as a hallway and is to be modelled as such (e.g. daytime). If an assessor is in doubt, then the space is to be zoned as daytime.

5. ZONING

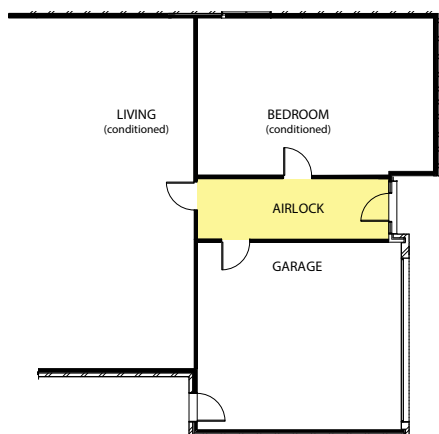

Figure 5-18: Airlock modelled as daytime

The airlock shown in [Figure 5-18](#) opens to the outside, an unconditioned zone (garage) and two conditioned zones (living and bedroom). Although the plan calls it an 'airlock', as it opens to two unconditioned zones it does not meet the NatHERS airlock requirements. In this case the airlock is essentially a hallway and must be zoned as daytime.

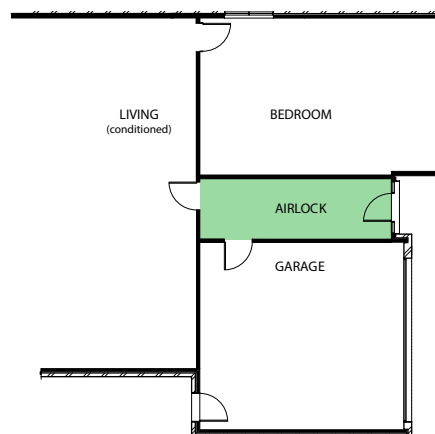

Figure 5-19: Airlock modelled as unconditioned

The airlock shown in [Figure 5-19](#) opens to the outside, an unconditioned zone (garage) and a conditioned zone (living). It meets the NatHERS airlock requirements as it only opens to one conditioned zone. In this case the airlock can be zoned as unconditioned.

5.5.6 Studios, bedsits and open-plan apartments

5i Studios, bedsits and open-plan apartments must be modelled with at least three zones:

- kitchen/living
- bedroom
- unconditioned. (**Tech Note clause 5.3**)

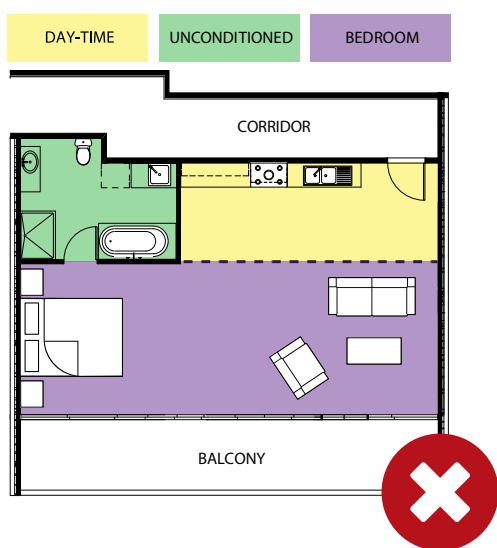

Figure 5-20: Incorrect zone division

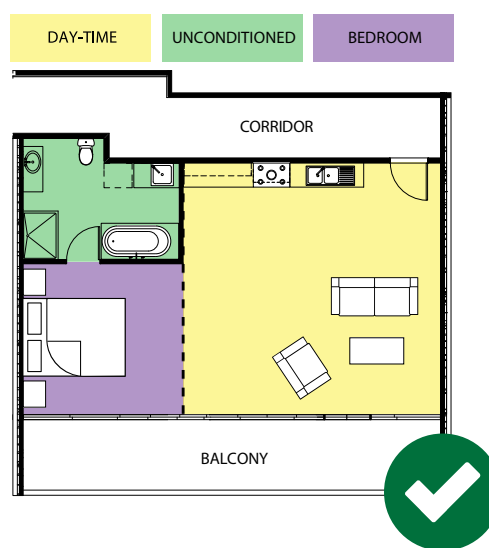

Figure 5-21: Correct zone division

5. ZONING

Note: The NatHERS Administrator is currently investigating the possibility of revising the NatHERS requirement for an unconditioned zone in studios, bedsits and open-plan apartments for situations where the entire apartment is conditioned. As this consideration would be a major change in intent of the NatHERS Technical Note, this is being explored and the impacts and implications of this change assessed so it can be considered as an option for future NatHERS updates.

Zone divisions must occur where a feature exists that would indicate the zone, and/or where furniture is likely to be located. For example, the permanent wall between the unconditioned zone and kitchen zones in the figures above is the feature in the room that indicates the line of a separate zone. The likely location of the bed is shown to identify the bedroom zone and the likely location of the sitting area is shown to identify the kitchen/living (Figure 5-21).

Between these zones with an open-plan division, assessors must model a plasterboard-on-stud internal wall with permanent openings no greater than 60% of the wall area. (Tech Note clause 5.3)

- 5i** When there are no obvious features by which to zone the open-plan studio or bedsit, the following minimum conditioned zone areas must apply:
- kitchen/living zone area(s) = minimum of 30% of the total conditioned floor area
 - bedroom zone area = minimum of 20% of the total conditioned floor area. (Tech Note clause 5.3)

5.5.7 Outdoor living areas

An 'outdoor living area' may be shown on documentation as a glazed verandah, portico, sunroom, wintergarden, conservatory, enclosed balcony/porch or other similar descriptions. Depending on the characteristics of the outdoor living area, for NatHERS modelling purposes these spaces may be required to be zoned, or just incorporated as a shading element.

- 5j** Conditioned outdoor living areas (i.e. mechanically heated or cooled) must be considered within the dwelling envelope and assigned a zone when capable of being fully enclosed by solid construction elements (e.g. walls, windows, bi-fold or sliding doors) (Tech Note clause 5.1)
- 5k** Outdoor living areas (enclosed or partially open), 'alfresco' spaces and detached garages are not allocated a zone and are an exception. These areas must be considered for shading purposes only. (Tech Note clause 5.1)

For example, if a portico is attached to the dwelling by solid construction elements and capable of being enclosed but has plastic blinds as wall elements along one side, it is not capable of being fully enclosed entirely by solid construction elements and therefore is only to be modelled for shading and not as a zone.

Another example would be an enclosed sunroom attached to the dwelling, with large bi-fold or concertina doors opening up the space to the garden. Even though the space may have a fan for cooling, or fireplace for heating for example, unless it is documented as being mechanically heated or cooled (e.g. air conditioner unit, ducted heating/cooling system or evaporative cooling specified), this space would not be zoned.

Note in both these examples it is assumed the spaces can be closed off to the rest of the dwelling. If the space was open to other zones of the dwelling and therefore permanently open to the dwelling envelope, it is not capable of being fully enclosed and must be modelled as a zone within the dwelling, regardless of if the documentation shows it as mechanically heated or cooled.

When modelling outdoor living areas with glazed roofs for shading purposes, the assessor may wish to use their professional judgement about the impacts of this on the dwelling. For example, it may be appropriate to apply a 10% shading factor when modelling a horizontal shading element/device with a clear glass material. This is similar to editing the shading factor when modelling polycarbonate shading surfaces or lattice/slats, if this feature is available in the software tool. Solid structures/materials would have a shading factor of 100%.



5. ZONING

5.5.8 Double height voids

When modelling a double height zone that extends across two levels of the dwelling, the upper void area is incorporated into the parent zone so that the void and the zone below effectively become one zone. This has been a recent improvement in the capability of the Chenath engine in version 3.21.

Modelling double height voids using this method provides improved accuracy for ratings and consistency across all NatHERS assessments and climate zones. Some of the implications for this include correct calculation of air flow between vertical and horizontal openings between adjoining zones, as this approach also allows heat from windows in the upper portion of the zone to be correctly allocated to the floor of the zone.

[Figure 5-22](#) shows the correct modelling of a double height void incorporated into the parent zone below. [Figure 5-23](#) demonstrates less accurate modelling methods, which should only be used if using Chenath engine 3.13 or earlier.

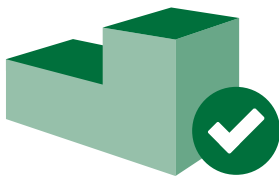

Figure 5-22: Correct double height void modelling

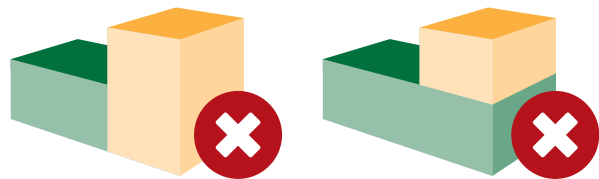

Figure 5-23: Incorrect double height void modelling

[Figure 5-22](#) shows correct modelling of a double height void, as one combined zone. See relevant software tool manual for more guidance on modelling correct heights and specific data input.

[Figure 5-23](#) shows incorrect modelling of a double height void, as two zones. These methods were acceptable when using Chenath engine version 3.13 but the improvements to version 3.21 allow the more accurate modelling method demonstrated in [Figure 5-22](#).

For detailed guidance on how to model double height voids, assessors should refer to the relevant software tool manual.

5.5.9 Modelling domestic lifts

Domestic lifts, or elevators, are designed for domestic use, usually in a single-family class 1a home. Unenclosed stair lifts do not need to be modelled.

There are two classes of domestic lift that need to be modelled in a NatHERS assessment:

1. lift with an enclosed shaft
2. lift without an enclosed shaft

5. ZONING

Lifts with fully enclosed shafts

Lift shafts may be situated internally in a dwelling (Figure 5-24) or attached on the outside of dwelling (Figure 5-25).

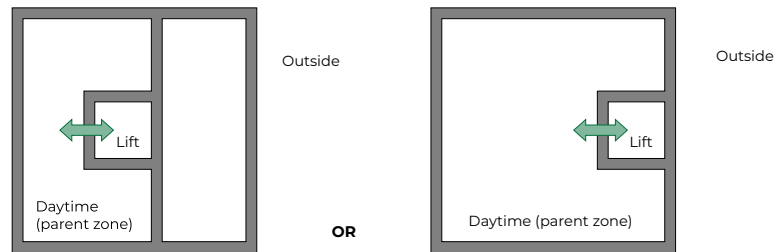

Figure 5-24: Enclosed lift shaft – internal

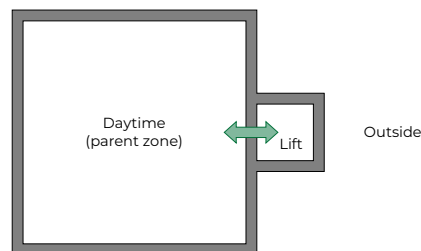

Figure 5-25: Enclosed shaft – external

The assessor should model a shaft zone at each level of the dwelling (except in AccuRate which allows an assessor to model the entire shaft as a single zone). For each shaft zone model:

- all walls with the appropriate adjacencies and construction material
- all lift doors
- any glazing on external walls
- horizontal openings between each level which fills the zone¹
- zone as 'daytime'

Therefore in a 2-storey house 2 lift shaft zones must be modelled. In a 3-storey house 3 lift shaft zones (Figure 5-26) must be modelled. The exception is AccuRate which allows a lift shaft to be modelled as a single zone.

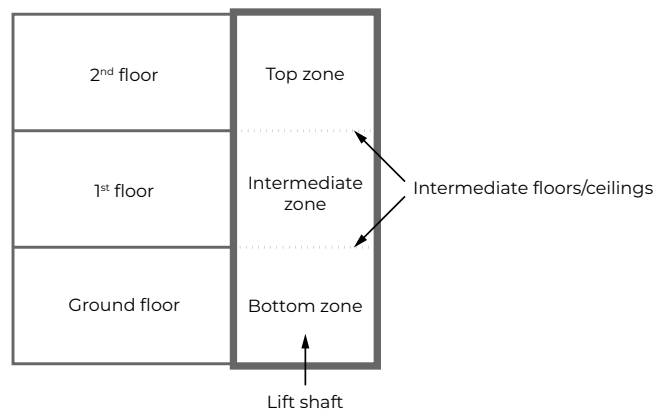

Figure 5-26: Section of a domestic lift shaft servicing 3 levels of a building

¹ In rare circumstances lift shaft documentation may be detailed sufficiently to enable the exact horizontal opening dimensions to be modelled.

5. ZONING

Semi enclosed lifts – through floor

This type of lift does not have a fully enclosed lift shaft.

Assessors should model this as a horizontal opening only - similar to a staircase between levels.

Semi enclosed – in a double height void

This type of lift is typically installed in a double height void (Figure 5-26). No modelling is required as the lift is open to the zone it is located in.

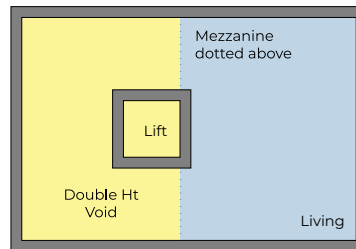

Figure 5-27: Plan view: semi-enclosed lift in a double-height void

5.6 Floor and wall adjacency zones

Chenath engine version 3.21 incorporated two zones that are required when modelling particular scenarios of floor or wall adjacency. These are the only two situations where assessors must model a zone outside the dwelling envelope.

5.6.1 'Glazed common area' zone

In Class 2 or 4 buildings, a dwelling wall may be adjacent to an external wall, another dwelling (neighbour), enclosed stairs and lifts or a common corridor (conditioned or unconditioned).

The 'glazed common area' zone is applied to unconditioned common corridors with glazing when the dwelling wall does not have open air or another dwelling on the other side of the zone. Assessors must not apply this zone if the corridor is only semi-enclosed (e.g. verandah-style) or is specified as conditioned. In either of the latter two cases the corridor is not modelled and the dwelling wall is modelled as adjacent to 'neighbour'.

When the glazed common area zone is longer than the dwelling wall, the assessor can model this in one of two ways:

- Model the zone to be the length of the dwelling and each end is modelled with internal walls adjacent to 'neighbour'. The exception to this would be where an external wall is shown – then it should be modelled accordingly.
- Model the zone to be longer than the dwelling wall – for example if there was a window opening at the end of the corridor assessors decide might be beneficial to model – this is also acceptable.

The characteristics of the zone's floor, external walls and ceiling need to be modelled (e.g. construction materials, windows and zone adjacency). The entrance door to the dwelling must not be modelled, as no ventilation to the outdoor air is assumed. The area of this zone does not contribute to the dwelling's total floor area calculations (shown on the NatHERS Certificate).

See [Section 7.5 of Chapter 7 \(Walls\)](#) for more information on wall adjacency and its application and modelling, as well as the NatHERS requirements outlined in the NatHERS Technical Note clause 7.3 and Table 3.

5. ZONING

5.6.2 'Shared basement carpark' zone

In Class 2 or 4 buildings, a dwelling's floor may be adjacent to earth, another dwelling (neighbour) or carpark or shared basement (unconditioned).

The 'shared basement carpark' zone is to be used for dwellings directly above an underground carpark (or unconditioned space), when:

- the zone floor is in contact with the ground (or another level of carpark), and
- there is a zone ceiling with a zone above, a zone roof with open air above, or a combination of both, and
- the external wall is either fully adjacent to earth, or less than 50% of the wall height is exposed to air.

The Chenath engine assumptions are that these underground carpark unconditioned spaces will be more protected than a carpark adjacent to 'outdoor air'. Hence the carpark walls should be included for ground heat loss calculations. The shared basement carpark zone is not to be used when the carpark is entirely above ground, external walls are greater than 50% above ground, or there are openings on two opposing external walls which are greater than 50% of the wall area.

When modelling this zone the entire 'shared basement carpark' level (including areas adjoining other dwellings, shared common areas or open areas) must be included in the NatHERS assessment. If there is more than one 'shared basement carpark' level, assessors are to model the uppermost level directly under the dwelling and assume it is on ground. Assessors are to model the underground external walls as retaining walls with a 5m thick soil layer at the back of the wall.

The characteristics of the zone's floor, external walls and ceiling are to be modelled (e.g. construction materials, windows, roller doors and zone adjacency). The area of this zone does not contribute to the dwelling's total floor area calculations (shown on the NatHERS Certificate).

See [Chapter 6.4](#) of Chapter 6 (Floors) for more information on floor adjacency and its application and modelling, as well as the NatHERS requirements outlined in the NatHERS Technical Note clause 6.4 and Table 2.

5.7 Zoning ambiguous spaces

Sometimes it can be hard to determine the zoning of a particular room, especially when its purpose is not specific or is ambiguous on the plans (e.g. a music room, hobby room, storage room, bar, butler's pantry, playroom, cat room, reading room or other rooms creatively named by the designer).

Assessor discretion is required in some instances where the name of a space given on the drawings may be different from the way an assessor would categorise the space for modelling purposes.

The key to determining the zoning of such spaces is to ignore the name given to the space on the drawings and instead look at the features and intended use of the room.

Answering the following questions regarding use may help to determine the zoning of such a space:

- Is the room likely to be used as a daytime or night-time space?
- What zoning does the room resemble if the name on the drawings is removed?
- Could the room be used as a bedroom?
- Does it have a cupboard or wardrobe?
- What are the adjacent spaces?



6

Floors

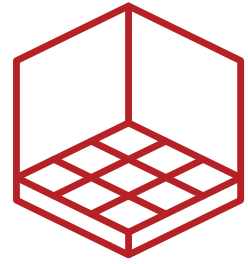

IN THIS CHAPTER

6.1	Floor height	51
6.2	Floor types	53
6.3	Floor coverings	55
6.4	Adjacent floors	55
6.5	Thermal bridging	57

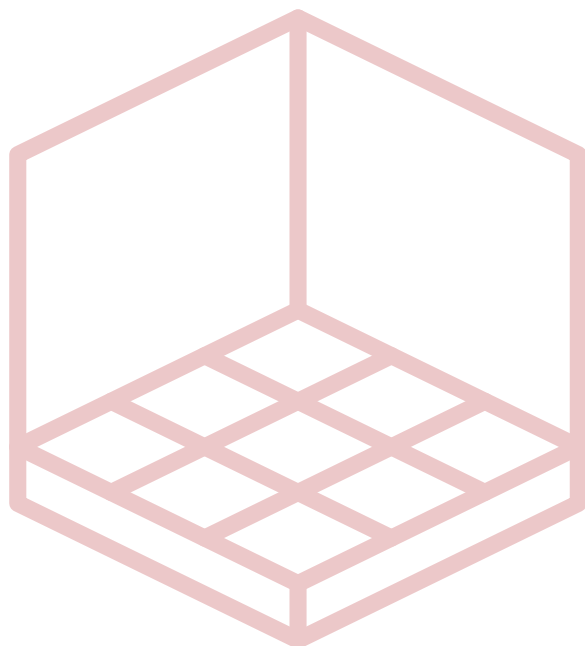

6

Floors

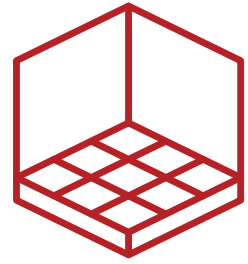

Modelling floors involves calculating floor heights and adding details of floor types, coverings and adjacency (situations where there may be a neighbour or open air underneath a floor).

Summary of key requirements

This handbook is intended to be a helpful resource for all assessors. When conducting assessments, assessors must follow the requirements of the current NatHERS Technical Note and the relevant state or territory requirements.

- 6a** The Assessor must enter the correct floor height as this determines the extents of which the dwelling is exposed to wind ([Section 6.1](#)).
- 6b** Floor types have a significant impact and must be accurately identified and entered in the software ([Section 6.2](#)).
- 6c** Where no floor coverings are specified in the documentation, assessors must use the following defaults:
 - garages have concrete floors
 - wet areas, butler's pantries and kitchens have ceramic tiles
 - small storage and void spaces have the same floor finish as the parent zone
 - all other areas have carpets with rubber underlay

If the floor covering material colour is not specified on the drawings the default colour medium (solar absorptance = 0.5) must be modelled.
- 6d** Assessors must model floor adjacency of dwellings directly above carparks or unconditioned public spaces as per [Table 6-1](#) (Table 2 of the NatHERS Technical Note). (**Tech Note clause 6.7**)
- 6e** If the dwelling is steel framed construction, thermal bridging must be modelled ([Chapter 11](#)). (**Tech Note clause 11**)

6.1 Floor height

- 6a** The Assessor must enter the correct floor height as this determines the extents of which the dwelling is exposed to wind.

For NatHERS software tools to calculate a rating, a height above ground must be entered for the ground or lowest floor, including dwellings with a concrete slab on ground. If the lowest space of the dwelling is a floor level below ground (i.e. basement) the floor level height may be entered as a negative figure. The height is primarily used to determine the extent to which the dwelling is exposed to wind. For example, the higher the dwelling is off the ground, the higher the wind speed the dwelling is exposed to. This is most relevant to Class 2 dwellings where apartments are higher above ground and significantly impacted by a change in exposure and wind speed. (see [Chapter 4](#))



6. FLOORS

6.1.1 Floor height for individual dwelling

The height of a floor above ground for an individual dwelling is one of the following:

- the finished floor level (FFL) of the concrete slab thickness above the natural ground (if known)
- an assumed FFL of the concrete slab thickness above ground (minimum 150mm)
- the average height of the FFL of a suspended floor above the ground
- the height of the FFL of the storey within a multi-level dwelling.

For multi-level dwellings, assessors should consult their relevant software tool manual and ensure correct floor and ceiling heights are modelled.

6.1.2 Floor heights on sloping sites

Floor heights on sloping sites may vary across the building footprint. The floor height above ground level on a sloping site is to be the average floor height across the building footprint.

Contours are the lines on a site plan representing the slope of the land. The closer together the contour lines are drawn, the steeper the land. Information on heights above ground level for sloping sites may also be available on elevations and sections as part of the design documentation.

To calculate the average floor height on complex sloping sites, assessors may measure the dwelling height above ground at four corners of the dwelling and calculate the average. If the slope is only in one direction, and relatively even across the length of the dwelling, assessors may choose to use a simple method of calculating the average as shown in Figure 6-2.

Add the lowest and highest points of the dwellings floor above natural ground level and divide by two.

- A = 1000mm, B = 3000mm
- Average height above ground = $\frac{A+B}{2} = 2000\text{mm}$

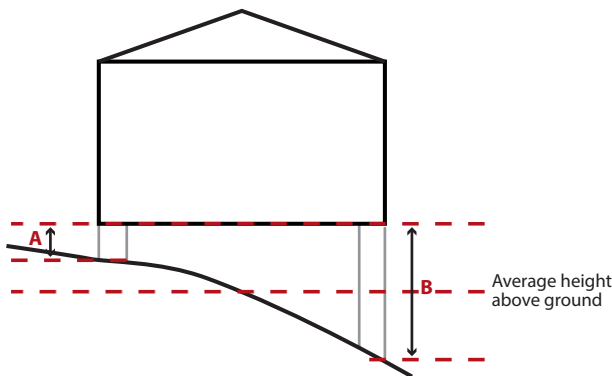

Figure 6-2: Calculating average floor height above ground

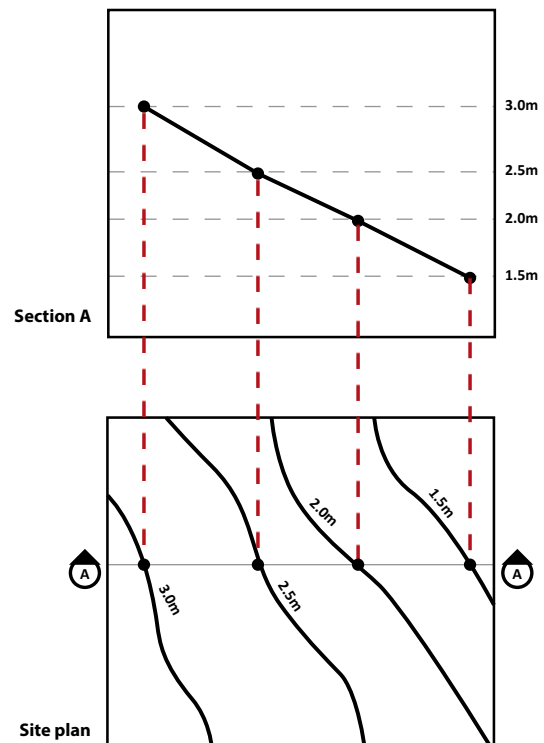

Figure 6-1: Sloping sites

6. FLOORS

6.1.3 Floor height for dwellings in a multi-unit building

The floor height for a specific apartment in a multi-unit building must use the FFL for that specific apartment. Apartments are considered as an individual dwelling. The FFL height above ground is entered in the same way as a dwelling with a suspended floor.

To calculate the floor height for an apartment within a multi-unit building, floor heights and floor thicknesses of each level below the apartment being assessed are to be added to the building FFL to determine the FFL of the apartment.

Figure 6-3 shows an example of how to calculate floor heights in multi-unit dwellings.

The floor height of level 4 is 9300mm (300 + 2700 + 300 + 2700 + 300 + 2700 + 300).

The exception to this calculation is when assessors are calculating the second storey floor level of a two-storey apartment. In this case, assessors are to use the same method as the second storey floor level of a two-storey dwelling and should consult their relevant software tool manual and ensure correct floor and ceiling heights are modelled as outlined in Section 6.1.1.

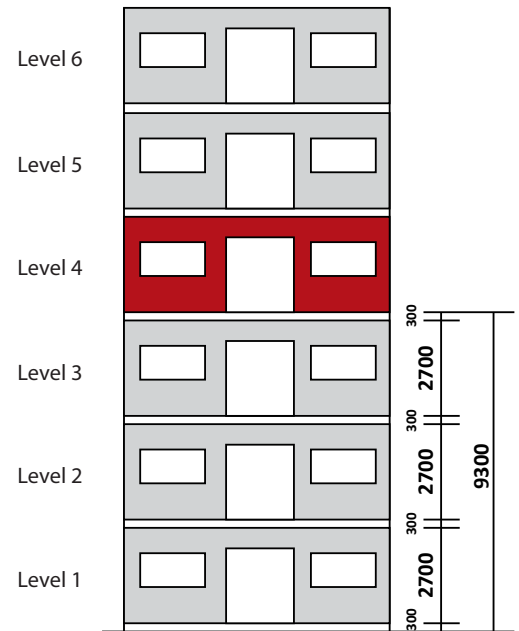

Figure 6-3: Calculating floor height in multi-unit buildings

6.2 Floor types

6b Floor types have a significant impact and must be accurately identified and entered in the software.

Floor types can have a significant impact on the thermal performance of a dwelling, particularly through the addition of thermal mass. The floors of residential dwellings are usually concrete or timber, either on ground (e.g. waffle pods) or suspended. For information on other floor types, visit the Your Home website: www.yourhome.gov.au/materials.

6.2.1 Concrete slab floors

A concrete slab that receives good solar radiation (direct sun) in winter can be a significant source of thermal mass to store heat in cold climates that need heating. As long as it is protected from the summer sun, it can also be a cooling source in hot weather.

When concrete slab floors are connected to the ground they can receive additional benefits from the ground temperature, which is generally more moderate than the air temperature – cooler than the air in summer and warmer than the air in winter.

Concrete slab floors on the ground can be insulated at the sides to prevent heat loss or gain to the air. Depending on the climate, adding under-slab insulation may also prevent heat loss. However, this may not be the case in extremely hot or cold climates, where the ground temperature may be more extreme. The Chenath engine has some limitations in modelling the ground-coupled heat transfer of slab edge insulation scenarios. If this type of insulation is specified on the documentation and assessors are unsure how to model it, they should refer to the software tool manual or contact their AAO for advice.



6. FLOORS

Some concrete slabs are suspended above the ground because the slope of the site makes a single continuous slab at the same level difficult. This can also provide cooling benefits when constructed in hotter climates. When a suspended concrete slab floor is used:

- insulation under the slab may be beneficial in colder climates (that require heating) to prevent the loss of heat through the bottom of the slab to the air
- insulation under the slab may not be beneficial in milder climates if the subfloor is enclosed and there is no central heating or air conditioning used in the dwelling, because there will not be significant heat loss or gain through the slab
- insulation under the slab may not be beneficial in warmer climates (that require cooling) as it is more beneficial for air to circulate under the elevated floor to increase the loss of heat to the slab and keep it cooler.

6.2.2 Timber floors

Timber floors are often used in lightweight construction and may be good in hotter climates. However, they provide very little thermal mass (which can help to maintain consistent temperatures inside the dwelling) and the open, ventilated subfloor results in greater heat loss or gain through the timber floor, which is not ideal in colder climates.

Timber floors, when used in colder climates that require predominantly heating, should ideally be enclosed to restrict air flow under the floor, while still allowing sufficient air movement for healthy ventilation to the floor timbers. They should also be well insulated to reduce the loss of heat through the floor. When a timber floor is used in a brick veneer construction, it is also ideal to reduce air flow between the roof space and the subfloor via the wall cavity.

In hotter climates, a raised timber floor can provide cooling by allowing heat that has built up in the dwelling to escape through the floor by the cooling effect of convection. If this is the desired effect, then the floor should not be insulated. If, however, a dwelling in a hotter climate has air conditioning, insulation should be included under the floor to reduce the entry of heat from the outside air and the loss of air conditioning through the floor.

If the dwelling has a steel framed floor, thermal bridging modelling rules may apply. Refer to [Chapter 11](#).

6.2.3 Waffle pods

Waffle pods are a construction method that uses expanded polystyrene (EPS) blocks under the concrete slab. There are a number of reasons why waffle pods may be used, including good insulation qualities, reduced amount of concrete required and assisting with particular requirements of a construction site.

Where EPS waffle pods are specified, assessors must use the waffle pod thickness:

- closest to what is on the design documentation, but never higher
- measured from the underside of the top slab to the bottom of the waffle pod construction. (**Tech Note clause 6.1**)

Where the thickness of a waffle pod is not indicated on the documentation, the default 175mm thickness (R-value 0.57) must be used. (**Tech Note clause 6.2**)

Depending on the software tool, the respective R-value of these waffle pods may be built into the material/construction types or options available. If the software tool allows this information to be entered, the thermal resistance of is to be:

- 175mm waffle pod thickness = R 0.57
- 225mm waffle pod thickness = R 0.60
- 300mm waffle pod thickness = R 0.63
- 375mm waffle pod thickness = R 0.65.

The above R-values are for waffle pods only and cannot be used for other underfloor insulation types.



6. FLOORS

6.2.4 Non-insulating void forming construction

For the purpose of a NatHERS assessment, any non-insulating void forming construction (**Tech Note clause 6.4**) must be modelled as a conventional concrete slab-on-ground construction if:

- thickness = the thickness of the top continuous concrete layer
- floor height above ground = the total depth of the void former plus the continuous concrete cover
- there is a reflective membrane underneath – include a horizontal air gap >66mm (90 nominal) unventilated reflective (0.2/0.9, E = 0.20).

6.2.5 Other floor insulation

Knowledge of insulation and airgaps is essential to getting the data entry correct because it will affect the total R-value of the element.

Assessors should have a sound working knowledge of the available insulation products and how, when and where the products can be used, including those that can be used under the floor. Information to assist assessors is available at Your Home, from manufacturers, suppliers and on the internet.

Assessors should also know how to calculate the total R-value of an element, such as a floor, and how to calculate the depth of an air gap and the emissivity associated with it. For more information about insulation, including definitions, insulation types and calculating R-values, see [Section 7.3](#).

6.3 Floor coverings

There are many floor coverings available in NatHERS software tools, the most common of which are carpet, tile, vinyl and floating timber floorboards. There may be some variation between software tools in how coverings are entered. Assessors should refer to the relevant software tool manual for more information.

6c Where no floor coverings are specified in the documentation, assessors must use the following defaults:

- garages have concrete floors
- wet areas, butler's pantries and kitchens have ceramic tiles
- small storage and void spaces have the same floor finish as the parent zone
- all other areas have carpets with rubber underlay.

If the floor covering material colour is not specified on the drawings the default colour medium (solar absorptance = 0.5) must be modelled. (**Tech Note clauses 6.5**)

When applying these provisions, assessors should inform the client that these may not represent the best possible performance and that different floor coverings may improve the rating in some climate zones.

6.4 Adjacent floors

Care needs to be taken when rating apartments to ensure that adjacent spaces and their conditioning are correctly classified. In Class 1 buildings, it is unlikely floors will be adjacent to anything other than the ground, another storey of the same dwelling or over outside air below. In Class 2 and Class 4 buildings, beneath the dwelling floor may be another apartment or a shared carpark or unconditioned public space. Common carparks and basements below Class 2 and 4 dwellings cannot be treated as subfloor zones or garages.

6d Assessors must model floor adjacency of dwellings directly above carparks or unconditioned public spaces as per Table 6-1. (**Tech Note clause 6.7 and Table 2**)

The 'shared basement carpark' zone is to be used when the dwelling is above an underground car park or unconditioned space and the zone floor is in contact with the ground (or another level or carpark), the zone ceiling is shared with a dwelling above, and the external walls are either fully adjacent to earth or less than 50% of the wall height is exposed to air. This zone type is therefore not to be used when the carpark is entirely above



6. FLOORS

ground, external walls are greater than 50% above ground, or there are openings on two opposing external walls which are greater than 50% of the wall area.

These underground carpark unconditioned zones will be more protected than assuming adjacent to 'outdoor air', and the carpark walls should be included for ground heat loss calculations. The area of this modelled zone will not be included in the total floor area calculations and external wall openings do not need to be modelled as these openings form part of the zone algorithms. The specifications of the carpark zone's floor, external wall and ceiling details are required to be modelled. When the ceiling area of the zone is to neighbouring or other dwellings it will need to be modelled as adjacent to 'neighbour'.

Table 6-1: Floor, ceiling or wall adjacencies in Class 2 and 4 buildings

#	Adjacent area	Construction feature			
		Floor adjacent to ...	Ceiling adjacent to ...	Wall adjacent to ...	Dwelling entrance door
1.	Apartment	Neighbour	Neighbour	Neighbour	Model 0% openability
2.	Shared basement carpark — enclosed	Shared basement carpark zone ¹	--	Shared basement carpark zone	Model 0% openability
3.	Shared basement carpark — ventilated	Outside air	Outside air	Outside air	Model 0% openability
4.	Garage (private) — accessed from dwelling and own vehicular access door NOT part of larger enclosed basement carpark	Garage zone	Garage zone	Garage zone	Model 0% openability
5.	Garage (private, walled) — accessed from dwelling and own vehicular access door and PART OF larger enclosed basement carpark	Shared basement enclosed carpark zone	Shared basement enclosed carpark zone	Shared basement enclosed carpark zone	Model 0% openability
6.	Commercial premises	Neighbour	Neighbour	Neighbour	Model 0% openability
7.	Common corridor — no glazing, conditioned, enclosed	Neighbour	Neighbour	Neighbour	Model 0% openability
8.	Common corridor — no glazing, unconditioned, enclosed ²	Neighbour	Neighbour	Neighbour	Model 0% openability
9.	Common corridor — with glazing, unconditioned, enclosed	Glazed common area zone ³	Glazed common area zone	Glazed common area zone	Model 0% openability

1 Model entire zone including floor (only the level directly adjacent to the dwelling and assume it is on ground); external walls and their adjacencies (including the underground external walls as retaining walls with a 5m thick soil layer), ceilings and roofs and their adjacencies.

2 e.g. corridors accessible via lifts, or stairwells, or with an airlock between corridor and external air

3 This applies if:

- the apartment wall is adjacent to any glazing or
- the apartment is directly opposite any glazing and closer than 3 times the height of the corridor's ceiling (e.g. if the ceiling is 3 metres high, model apartments opposite any glazing if they are within 9 metres)

Model either:

- entire zone or



6. FLOORS

#	Adjacent area	Construction feature			
		Floor adjacent to ...	Ceiling adjacent to ...	Wall adjacent to ...	Dwelling entrance door
10.	Common corridor — with glazing, conditioned	Neighbour	Neighbour	Neighbour	Model 0% openability
11.	Common corridor — with permanent opening to outside air	Outside air	Outside air	Wall with eaves same length & width	Model documented openability
12.	Common public area — mostly enclosed	Neighbour	Neighbour	Neighbour	Model 0% openability
13.	Common public area — highly ventilated	Outside air	Outside air	Outside air	Model documented openability
14.	Lift	Neighbour	Neighbour	Neighbour	Model 0% openability
15.	Stairwell — enclosed	Neighbour	Neighbour	Neighbour	Model 0% openability
16.	Stairwell – open	Outside air	Outside air	Outside air	Model documented openability

6.5 Thermal bridging

6e If the dwelling is steel framed construction, thermal bridging must be modelled ([Chapter 11](#)). (**Tech Note clause 11**)

Thermal bridging modelling is only undertaken for dwellings with steel framed construction. Refer to [Chapter 11](#) for background information and modelling.

· zone section adjacent to the apartment wall and including the relevant glazed



7

Walls

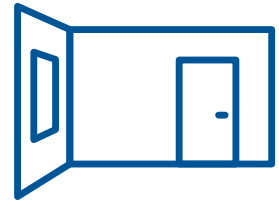

IN THIS CHAPTER

7.1	Wall types	60
7.2	Wall height	60
7.3	Insulation	61
7.4	Wall colour	65
7.5	Adjacent walls	65

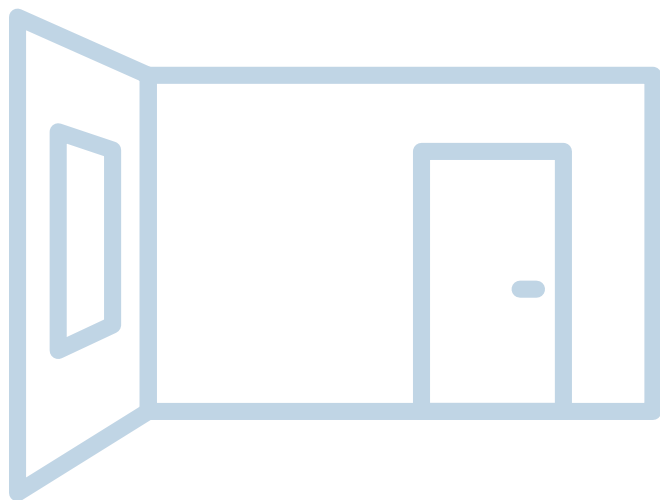

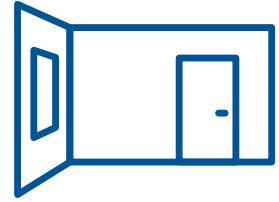

There are numerous combinations of wall constructions and insulation that can make up a dwelling. This chapter looks at the most common wall types, explains how to calculate the height of walls and provides a basic understanding of the types of insulation. This chapter also looks at wall adjacency, in terms of what is on the other side of a wall, which is particularly important in multi-dwelling buildings.

Summary of key requirements

This handbook is intended to be a helpful resource for all assessors. When conducting assessments, assessors must still follow the requirements of the current NatHERS Technical Note and the relevant state or territory requirements.

- 7a** If recommending changes to insulation, all documentation must be updated to reflect the changes before a NatHERS Certificate is finalised. Assessors must ensure recommended bulk insulation will fit within the wall cavity.
- 7b** Assessors must model the exterior wall colour or solar absorptance as detailed on the design documentation. In the absence of a solar absorptance value, this may be calculated as follows:
$$\text{Solar absorptance} = 1 - \text{solar reflectance value.}$$
- 7c** Where no exterior wall colours, solar reflectance or absorptance are specified, assessors must select the default colour as 'medium'.
- 7d** Dwelling walls adjacent to other dwellings, enclosed stairs and lifts, conditioned common corridors or unconditioned common corridors with no glazing are all to be modelled as adjacent to 'neighbour'. Adjacent dwellings are modelled as a conditioned space, regardless of the NatHERS zoning that would apply.
- 7e** Dwelling walls adjacent to common corridors open to external air (i.e. corridors with permanent openings) are to be modelled as external walls with eaves the depth and length of the corridor adjacent to the dwelling.
- 7f** Dwelling walls adjacent to an unconditioned common corridor with glazing are to be modelled as a 'glazed common area' zone. The zone must be the same width as the corridor and at a minimum, the length of the dwelling.
- 7g** If the dwelling is a steel framed construction, thermal bridging must be modelled ([Chapter 11](#)). (**Tech Note clause 11**)

7.1 Wall types

Although there are many different types of walls, most homes in Australia are built using one of several common construction methods. Some of the main construction methods used in Australia are:

- **Cavity brick** or **double brick**, in which two layers of brickwork are built side by side (with a larger gap between the layers in the case of cavity brick) and tied together at intervals for strength. This wall type has good thermal mass properties but lacks insulation properties.
- **Lightweight**, in which the walls are constructed of timber or steel framing, with timber or another kind of cladding outside, insulation in the middle and plasterboard or other lining inside. This wall type can have good insulation properties but lacks thermal mass properties.
- **Brick veneer**, in which the walls are constructed of timber or steel framing, with brick cladding outside, insulation in the middle and plasterboard or other lining inside. This wall type is similar to lightweight walls – it can have good insulation properties but lacks thermal mass properties inside the room.
- **Reverse brick veneer**, in which the walls are constructed of timber or steel framing, with brick lining inside, insulation in the middle, and timber or other kind of cladding outside. This wall type can have good insulation and has good thermal mass properties inside the room.

Other construction methods for walls include concrete blocks, composite construction systems, straw bales, autoclaved aerated concrete and mud bricks.

It is important to understand the advantages and disadvantages that construction methods may have in different climates, locations and for construction practices. More information about different construction systems is available at the Your Home website: www.yourhome.gov.au/materials/construction-systems.

The different NatHERS software tools have different types of walls available: some have the option to build walls from different wall elements, while others have a static list of options. Assessors must refer to the relevant software tool manual for more information about wall types or contact their Assessor Accrediting Organisation for modelling advice if the wall type shown on the documentation is not available in the software and they are unsure of what wall type to model.

7.2 Wall height

Wall height is the measurement between the finished floor level (FFL) and the finished ceiling level (FCL, which could include battening to the underside of the roof structure). Assessors should be aware of any variation between walls and ensure the wall height of each wall is entered accurately.

7.2.1 Wall heights in rooms with raked ceilings

Rooms or zones with a raked ceiling will have one shorter and one taller wall, and two walls that are not square. The actual wall heights of the shorter and taller walls are to be entered into the software tool. An average height is to be used for the walls that are not square unless the software tool has a raked wall function.

Figure 7-1 demonstrates this calculation method. The wall heights to be modelled in the software are:

- shorter wall (a) = 2400mm
- taller wall (b) = 2800mm (also maximum ceiling height)
- (c) = walls joining wall (a) and (b) = $\frac{a+b}{2} = \frac{2400+2800}{2} = 2600\text{mm}$

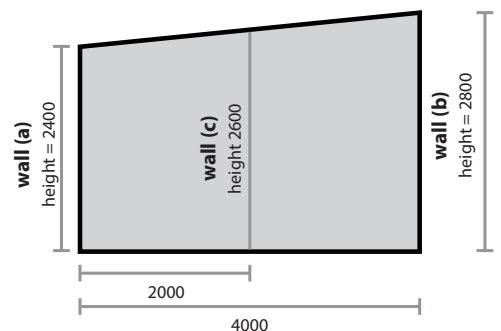

Figure 7-1: Raked ceiling calculations example – section view

7.3 Insulation

Knowledge of insulation and airgaps is essential to getting the data entry correct, as it will affect the total R-value of the element. There are some key concepts that assessors should understand about insulation and air gaps:

- **Emissivity** – Emissivity is a measure of how a surface emits or reflects heat energy and is calculated by the amount of energy emitted or radiated from a material's surface. Emissivity is a measure of how reflective a surface is; it is expressed as a number between 0 and 1. Low emissivity is more reflective, high emissivity is less reflective. Lower emissivity will produce a higher R-value in the adjacent enclosed air space.
- **K-value – Thermal conductivity**, or the measure of the rate of heat flow through a material and the ability of a material to allow the flow of heat from its warmer surface through the material to its colder surface. K-value is determined as the heat energy transferred per unit of time and per unit of surface area divided by the temperature gradient, which is the temperature difference divided by the distance between the two surfaces (the thickness of the material), expressed in watts per metre-kelvin. A material with a low k-value transmits low levels of heat (good insulator); a material with a high k-value transmits high levels of heat (poor insulator).
- **R-value – Thermal resistance** per unit area, or the measure of the resistance to heat flow through a specific thickness of a material. An R-value of 1 is equal to a U-value of 1. Higher numbers indicate better insulating properties. Thermal resistance (R-value) is the reciprocal of thermal transmittance (U-value). 'Total R-value' refers to the addition of each material/component's R-value. 'Added R-value' refers to the insulation material/component to be added to a wall, roof or floors to improve the thermal resistance of that system.

Assessors should have a sound working knowledge of the available insulation products (see [Section 7.3.1](#)) and how, when and where the products can be used. Information to assist assessors is available from manufacturers and suppliers. There is a difference between imperial and metric calculations of R-value. When researching products it is important the assessor confirms the R-value applied is suitable for Australia, particularly if the specification includes non-standard products or systems.

Assessors should also know how to calculate the total R-value of an element, such as a wall (see [Section 7.3.2](#)), and how to calculate the width of an air gap and the emissivity associated with it (see [Section 7.3.3](#)). NatHERS software tools contain default R-values for different elements. Where assessors do not have R-values for an element, NatHERS software tools contain features and calculators that allow the calculation and/or use of an element to be based on the k-value.

7.3.1 Insulation types

There are two main types of insulation:

- **Bulk insulation** – Bulk insulation reduces heat flow by creating small pockets of still air or another gas that is not a good conductor of heat. This trapped air or gas provides most of the R-value, rather than the material itself. For example, 100mm thick glass fibre insulation provides around R2.3, while 100mm glass without small pockets of air provides only R0.1. The thicker the bulk insulation, the higher the R-value. The higher the R-value, the slower the transfer of heat through the material.

The main types of bulk insulation used in Australia are:

- batts and blankets, for example fibreglass, rockwool, natural wool, jute and polyester
 - loose fill insulation, such as cellulose fibre, natural wool or granulated rockwool
 - boards (e.g. extruded and expanded polystyrene insulating boards)
 - some building materials, such as autoclaved aerated concrete blocks, strawboard and straw bales, which act as both a construction system and provide insulation as well.
- **Reflective insulation (foils)** – Reflective foil insulation usually consists of a thin layer of aluminium foil bonded onto the sides of a reinforced base ([Figure 7-2](#)). Reflective foil insulation reduces heat flow by using surfaces that are highly reflective, with low thermal emittance (does not emit heat) and absorptance (does not absorb heat). The emissivity is generally expressed as two values which describe the reflective orientation.



7. WALLS

It is not so much the material itself that provides the thermal resistance but the impact of the low-emittance surface that reduces heat flows across an air space. Therefore, unless reflective foil insulation faces an air space, it adds no additional thermal resistance.

The amount of reflection is measured as emissivity. The more reflective the surface, the less thermal radiation is emitted through the surface, so the lower the emissivity value (e.g. 0.9 is not reflective, 0.05 is very reflective).

The main types of reflective insulation used in Australia are:

- rolls (e.g. single- or double-sided rolls used for sarking)
- multi-cell insulation, consisting of two, three or four layers of laminated foil separated by partitioning
- expandable insulation (e.g. double-sided reflective foil laminate formed into an expandable concertina)
- bonded to bulk (e.g. reflective foil bonded to insulating blankets or polystyrene board).

Table 7-1 contains information that may be useful when using insulation in a NatHERS assessment.

Table 7-1: Insulation in NatHERS software

Unit of measurement	Bulk insulation		Reflective insulation (with air gap)	
	R-value (R)	Conductivity (k)	Emissivity (E)	R-value (R)
Value is represented as	>0	0–1	0.05–0.9*	>0
Format of value	To one decimal place	To two decimal places	To two decimal places	To one decimal place
Examples of values	R0.5, R1.5, R3.0	0.23, 0.33	0.9, 0.05	R1.5, R0.5, R3.0
Related to	Density (D or ρ)—Kg/m ³		Reflection into an adjacent air space	
Thickness of material	<ul style="list-style-type: none"> • Measured in millimetres and dependent on R value 		<ul style="list-style-type: none"> • 0–2mm and requires at least a 13mm air gap • May be attached to bulk product or another surface 	

*example only—check with specification/documentation to confirm this information and accurate percentage

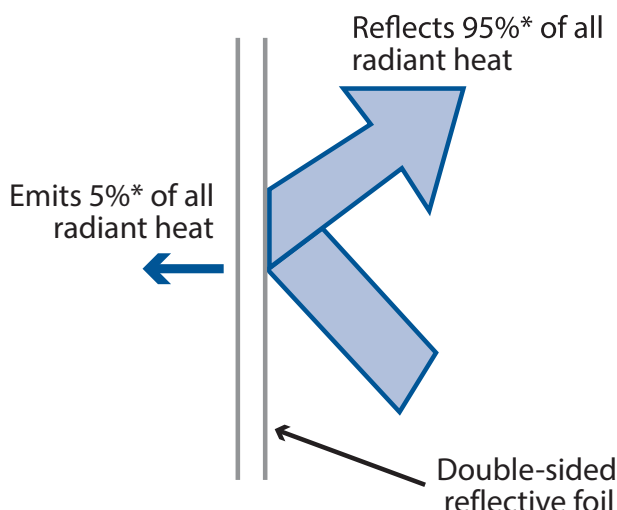

*example only—check with specification/documentation to confirm this information and accurate percentage

Figure 7-2: Thermal effect of reflective foil insulation

7. WALLS

When recommending insulation changes, assessors must ensure the product is suitable. It is important the insulation modelled as part of the assessment will fit into the designed space (e.g. wall cavity) because the NCC and Australian Standard require that bulk insulation is not compressed. Where insulation is added to a wall, assessors must remove any air gap thickness that has been replaced by bulk insulation.

7a If recommending changes to insulation, all documentation must be updated to reflect the changes before a NatHERS Certificate is finalised. Assessors must ensure suggested bulk insulation will fit within the wall cavity. (**Tech Note clause 3.3**)

Details of insulation products, including thickness, R-value and k-value are generally available from the manufacturer's website. Further information about R and k values is available from the *ICANZ insulation handbook*: <https://icanz.org.au/wp-content/uploads/2023/03/FINAL-ICANZ-HANDBOOK-PART-2-V6-FINAL-13.12.2020.pdf>

7.3.2 Calculating the R-value of a wall

R-value means the thermal resistance ($\text{m}^2\text{K}/\text{W}$) of a material, which is calculated by dividing the thickness by its thermal conductivity. The total R-value of a wall is the linear total of the R-value of each element. Any variation in the R-value of a layer within the element, including any air gap, will change the total R-value. If an air gap is increased, the overall R-value will vary, which will also differ depending on whether reflective insulation is used adjacent to the air gap (see [Section 7.3.3](#)). As the total R-value increases, the insulation benefit improves. Depending on the assessor's software tool, these R-value components may be automatically calculated.

[Table 7-2](#) provides a list of common materials with example thickness and R-value. Assessors should always use the R-value recommended by the manufacturer or included in the specification/documentation. [Table 7-3](#) provides a list of common wall constructions with example thickness and R-values, if the assessor's software tool allows custom wall construction or modification.

Table 7-2: Example of material thickness and R value

Material	Thickness (mm)	R-value ($\text{m}^2\text{K}/\text{W}$)
Brick (generic extruded)	110	0.18
Brick (pressed clay)	110	0.12
Plasterboard	10	0.06
Fibre cement cladding	4.5–14	0.06
Metal cladding	1–2	0
Timber weatherboard	9.5	0.05
Reflective air gap	13	0.6
Non-reflective air gap	13	0.16

Source: Collated by Efficiency Assessments (examples only, assessors should always use the R-value provided by the manufacturer)



7. WALLS

Table 7-3: Example of wall constructions

Cavity brick with no insulation

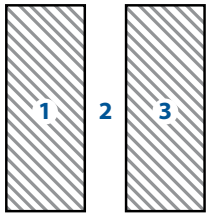

Layer	1	2	3
Material	Brick	Non-reflective airgap	Brick
Width	110mm	50mm	110mm
R-value	0.18	0.16	0.18
Total R-value	0.52		

Cavity brick with expanded polystyrene insulation

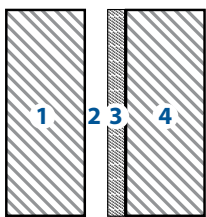

Layer	1	2	3	4
Material	Brick	Non-reflective airgap	Expanded polystyrene	Brick
Width	110mm	30mm	20mm	110mm
R-value	0.18	0.16	0.51	0.18
Total R-value	1.03			

Brick veneer with added R 2.5 studs

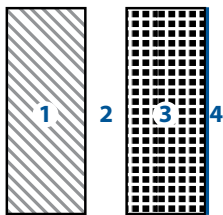

Layer	1	2	3	4
Material	Brick	Non-reflective airgap	Insulation added to stud R 2.5	Plasterboard
Width	110mm	50mm	90mm	10mm
R-value	0.18	0.16	2.5	0.06
Total R-value	2.9			

Brick veneer with no insulation

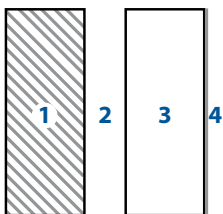

Layer	1	2	3	4
Material	Brick	Non-reflective airgap	Studs (with air gap)	Plasterboard
Width	110mm	50mm	90mm	10mm
R-value	0.18	0.16	0.18	0.06
Total R-value	0.58			

Fibre cement sheet wall with foil

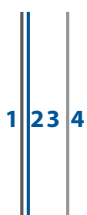

Layer	1	2	3	4
Material	Fibre cement	Single-sided foil	Reflective airgap	Plasterboard
Width	8mm	1mm	90mm	10mm
R-value	0.06	0	0.6	0.06
Total R-value	0.72			

7. WALLS

7.3.3 Calculating air gaps in walls

An air gap is the empty space between construction materials. Such gaps can provide a small level of insulation. An air gap can also be reflective or non-reflective:

- **Reflective air gap** – NatHERS software interprets the use of foils as a reflective airspace. This means there is a reflective surface facing the air gap and providing insulative qualities. Depending on the emissivity of the reflective insulation, it may be considered a 'semi-reflective air gap'. Where an air gap is accompanied by a reflective surface (e.g. foil insulation) it can have a bigger impact on the insulation properties of the wall
- **Non-reflective air gap** – Where an air gap is not accompanied by a reflective surface, the air gap is considered non-reflective.

The width of an air gap in a wall should be adjusted when insulation is added:

Modelled air gap = (width of air gap without insulation) - (thickness of uncompressed insulation)

Depending on an assessor's NatHERS software tool, the width of air gaps may need to be manually adjusted by the assessor. In others, a separate wall type is chosen to assess the changed R-value (refer to the relevant software tool manual). Assessors may also be able to specify in NatHERS software whether the air gap is 'ventilated' or 'unventilated' if this information is specified on the documentation.

7.4 Wall colour

The colour of walls affects how the dwelling reflects or absorbs heat and can be used to assist in heating or cooling the dwelling. Darker colours absorb heat while lighter colours reflect heat. It is therefore preferable to use darker colours on the walls in colder climates and lighter colours in warmer climates. For moderate climates, medium colours may be the most effective. Some testing may be required to identify the correct palette for the location and climate of the dwelling.

7b Assessors must model the exterior wall colour or solar absorptance as detailed on the design documentation. In the absence of a solar absorptance value, this may be calculated as follows:

Solar absorptance = 1 – solar reflectance value. (**Tech Note clause 7.1**)

7c Where no exterior wall colours, solar reflectance or absorptance are specified, assessors must select the default colour as 'medium'. (**Tech Note clause 7.2**)

7.5 Adjacent walls

Care must be taken when rating dwellings in multi-dwelling buildings to ensure that adjacent spaces and their conditioning are correctly classified. In most Class 1 dwellings adjacency is not a consideration because the software will assume that external walls are adjacent to 'outdoor'. This is what the software will default to unless altered by the assessor. However, in townhouses/terraces with shared walls, or Class 2 dwellings, an external wall may be shared with a neighbour and treated differently by the software. It is therefore important to enter adjacency information into the software tool.



7. WALLS

7.5.1 Adjacent to neighbour

7d Dwelling walls adjacent to other dwellings, enclosed stairs and lifts, conditioned common corridors or unconditioned common corridors with no glazing are to be modelled as adjacent to 'neighbour'. Adjacent dwellings are modelled as a conditioned space, regardless of the NatHERS zoning that would apply. (**Tech Note Table 2**)

An example of this is shown in [Figure 7-3](#), where Unit 6 is adjacent to dwellings, enclosed stairs and lifts, all of which are modelled as adjacent to 'neighbour' (red, yellow, green walls). Where the hallway has other apartments opposite and no ventilation (e.g. windows), the dwelling corridor wall (blue) is modelled as adjacent to 'neighbour'.

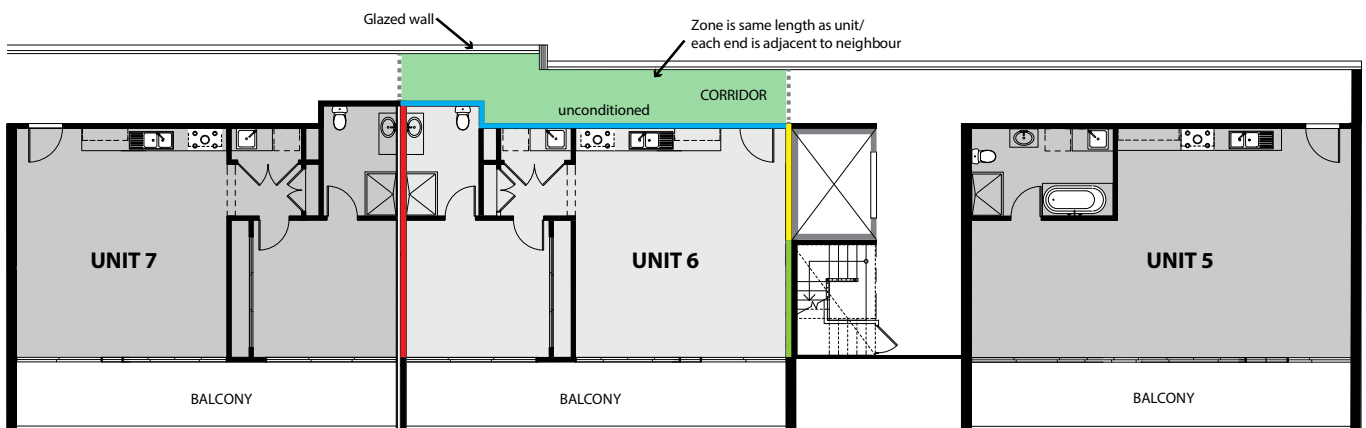

Figure 7-3: Adjacent to neighbour

7.5.2 Adjacent to external wall

7e Dwelling walls adjacent to common corridors open to external air (i.e. corridors with permanent openings) are to be modelled as external walls with eaves the depth and length of the corridor adjacent to the dwelling. (**Tech Note Table 2**)

For example, if the common corridor in [Figure 7-3](#) did not have apartments opposite, and the corridor had permanent openings (i.e. partly/fully open verandah-style), the dwelling wall (blue) is modelled as an external wall with shading the same size as the corridor or as appropriate. This is because ventilation flow is to open air when the corridor wall is only semi-enclosed.

7. WALLS

7.5.3 Adjacent to glazed common areas

7f Dwelling walls adjacent to an unconditioned common corridor with glazing are to be modelled as a glazed common area zone. The zone must be the same width as the corridor and at a minimum, the length of the dwelling. (**Tech Note Table 2**)

The 'glazed common area' zone is to be used for unconditioned common corridors with glazing when the dwelling wall does not have open air or another dwelling on the other side of the zone.

The area of this zone does not contribute to the total floor area calculations and the characteristics of the zone's floor, external walls and ceiling are to be modelled. The entrance door to the dwelling is not to be modelled as no ventilation to the outdoor air is assumed.

An example of this is shown in [Figure 7-4](#), where Unit 6 is adjacent to a dwelling and enclosed stairs and lifts, which are modelled as adjacent to 'neighbour' (red, yellow, green walls). Where the adjacent corridor is glazed, the corridor dwelling wall (blue) is modelled with a 'glazed corridor area' zone that is the same width and length as the corridor (at a minimum), and with wall adjacency to 'neighbour' or as appropriate at both ends. For detailed guidance assessors should refer to the relevant software tool manual.

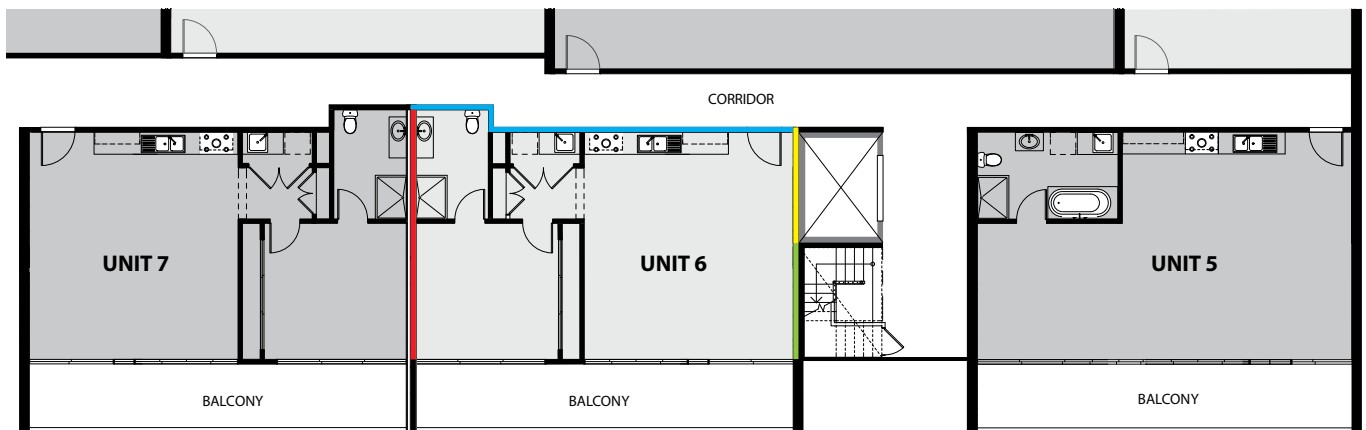

Figure 7-4: Adjacent to glazed common corridor

7g If the dwelling is steel framed construction, thermal bridging must be modelled ([Chapter 11](#)) (**Tech Note clause 11**)

Thermal bridging modelling is only undertaken for dwellings with steel framed construction. Refer to [Chapter 11](#) for background information and modelling guidance.

8

Windows and doors

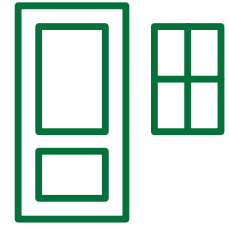

IN THIS CHAPTER

8.1	Window performance values	70
8.2	Window elements	72
8.3	Window libraries	74
8.4	Entering windows into software	83
8.5	Doors	87
8.6	Roof and high-level glazing	89
8.7	List of current NatHERS default window specifications	91

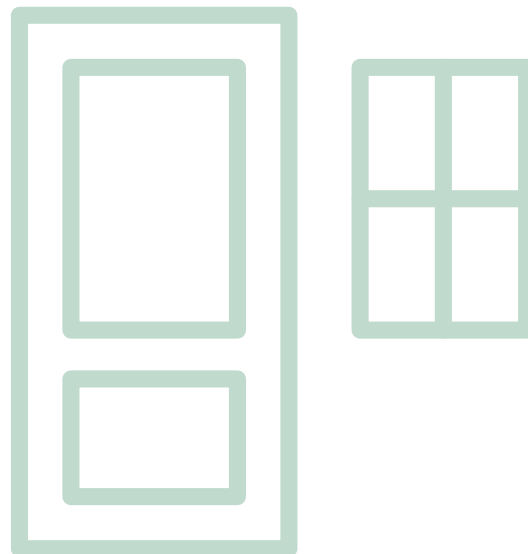

8

Windows and doors

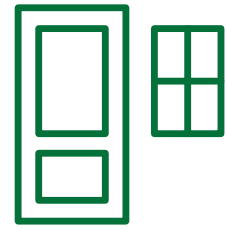

Windows have a substantial effect on the thermal performance of a dwelling. They can improve the performance by allowing ventilation, cross-breezes and solar heat gain but can also reduce the performance by allowing heat in during hotter seasons or heat to escape during colder seasons. As windows can severely affect the heating and cooling loads of a dwelling, improving the thermal performance of windows can greatly reduce energy costs and greenhouse gas emissions.

The effect of glazing on the thermal performance of a dwelling is complex. Several factors contribute to the effectiveness of windows:

- local climatic conditions – temperature, humidity, sunshine and wind
- design – the orientation, form and layout of the dwelling
- materials – the amount of mass and insulation (e.g. thermal mass can be used to store the entering sun's heat and provide night-time warmth in cold conditions)
- size and location of windows and shading – to let sunshine in when the outdoor temperature is cold, exclude it when it is hot, and allow natural cooling by cross-ventilation
- thermal properties of glazing systems – such as double-glazed, thermally broken window frames.

As glazing can significantly affect the rating, it is essential that window/door information is as accurate as possible. In NatHERS software, glazed doors are treated as windows and selected from the window libraries.

Summary of key requirements

This handbook is intended to be a helpful resource for all assessors. When conducting assessments, assessors must follow the requirements of the current NatHERS Technical Note and the relevant state or territory requirements.

- 8a** When modelling windows or glazed doors, assessors must use the Australian Fenestration Rating Council (AFRC) custom window codes corresponding to the windows specified in the design documentation or the WERSLink default window library or NatHERS default window libraries. **(Tech Note clause 8.3)**



8. WINDOWS AND DOORS

- 8b** If the software is using the WERSLink custom window library and a window is specified on the design documentation that is not available, an assessor must choose a default window from either the WERSLink default window library or the NatHERS default window library with the specified opening type as per **Tech Note clause 8.4**.
- 8c** If the specified custom window is not available in the NatHERS custom window library, assessors must model a default window from the NatHERS default window library with the specified opening type or an available custom window that meets all the parameters outlined in **Tech Note clause 8.5**. Substituted values must be based on the Australian Fenestration Rating Council (AFRC) protocol rather than, for instance, the European ratings.
- 8d** The minimum design documentation required when modelling windows and glazed doors should comprise window, skylight, roof window and door details, including size, glass type, frame type, openable percentage, opening style and location.
- 8e** When using default windows, obscure glass (for instance, in a bathroom or WC) may be considered as either clear if the glass is clear patterned, or tint if the glass is a tint or translucent laminate. (**Tech Note clause 8.6**)
- 8f** In the absence of obscure glass in the custom window libraries, assessors must model either a default clear window if the glass is clear patterned, or a default tint window if the glass is a tint or translucent laminate. If the glass is clear patterned then a clear window from the same range of custom windows that is being used (i.e. same frame type and frame material) must be modelled. If the glass is tint or translucent laminate, then a tint window from the same range of custom windows that is being used (i.e. same frame type and frame material) must be modelled. (**Tech Note clause 8.7**)
- 8g** When using the NatHERS default window library, assessors must apply the default openable percentages listed in [Table 8-3](#). (**Tech Note clause 8.8 and Table 4**)
- 8h** When using any custom windows, assessors must use the manufacturer's ventilation charts to determine the openability of the window/door. If this information is not available, apply the default percentages listed in [Table 8-3](#) (**Tech Note clause 8.8 and Table 4**)
- 8i** The glazed portion of a fully or partially glazed door is modelled as a window in NatHERS software tools. If the glazed component is less than 25% of the door, the door may be modelled as a solid door. (**Tech Note clause 8.2**)
- 8j** All unconditioned external garage doors must be modelled as not weather-stripped and all unconditioned garage windows must be modelled as not weather-stripped with insect screens, unless otherwise specified in the design documentation. All conditioned external garage doors must be modelled as weather-stripped and all conditioned garage windows must be modelled as weather-stripped with insect screens, unless otherwise specified in the design documentation. (**Tech Note clause 8.1**)

8.1 Window performance values

The factors often considered the most important in measuring the energy performance of a window are its U-value and solar heat gain coefficient (SHGC)¹. These factors indicate the ways in which windows react thermally.

The U-value (often expressed as U_w when referring to the total window system) is a measure of how readily a window conducts heat and the rate of non-solar heat loss or gain through the window unit (see [Figure 8-1](#)). The U-value includes the effect of the frame, glass, seals and any spacers. The lower the U-value, the greater a window's resistance to heat flow and the better it is at insulating and keeping the heat in or out.

¹ Reference to U-value and SHGC in this chapter (Chapter 8) refers to the total window system U_w and Solar Heat Gain Coefficient SHGC_w.



8. WINDOWS AND DOORS

The SHGC is a measure of how readily heat from direct sunlight flows through a window (see Figure 8-1); it is often expressed as SHGC_w when referring to the total window system (i.e. frame and glazing values combined). The SHGC is the fraction of incident solar radiation transmitted through a window, as well as the amount absorbed by the window and subsequently released inwards. The SHGC is expressed as a number between 0 and 1, where a lower SHGC equates to less solar heat transmitted. For example, 0 SHGC indicates that none of the available solar heat will pass through the window, while an SHGC of 1 indicates that 100% of the available solar heat will pass through the window.

In NatHERS software, the U-value and SHGC take into account the total window system values, including the individual window frame component and glazing values.

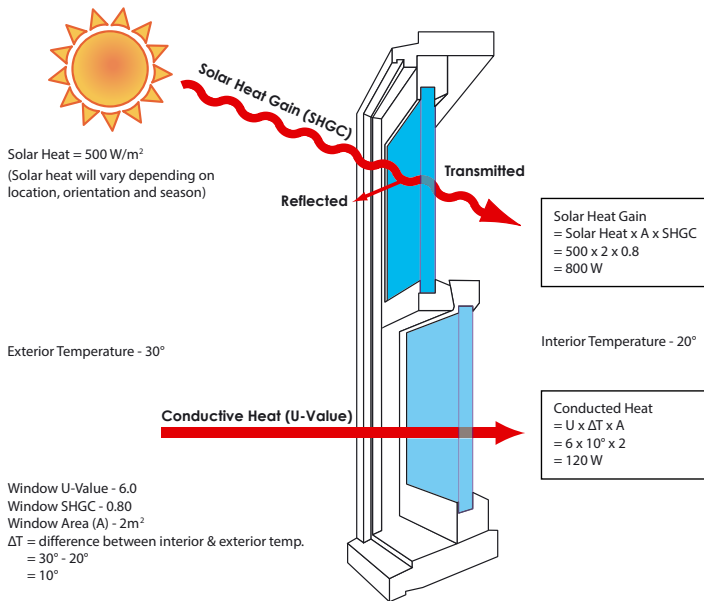

Source: Australian Glass and Window Association

Figure 8-1: Window conduction and solar heat gain

The angle at which solar radiation strikes glass – the angle of incidence – has a major effect on the amount of heat transmitted inwards. It is influenced by the position of the sun according to location (latitude), season and time of day, and the orientation of the glazing. When the sun is perpendicular to the glass it has an angle of incidence of 0°. For standard clear glass, 85% of solar heat is transmitted. As the angle increases, more solar radiation is reflected and less is transmitted, and the effective area of exposure to solar radiation also reduces. The SHGC declared by glazing manufacturers is always calculated as having a 0° angle of incidence – that is, the maximum solar heat gain.

The same window can have a vastly different solar gain depending on the angle of incidence. For example, a north-facing window in summer, when the sun is high in the sky, may have an angle of incidence of 66° in Hobart and 87° in Brisbane. In winter, the angle of incidence at midday is about 19° in Hobart and 40° in Brisbane and the glass is exposed to a greater effective area of solar radiation. The window can transmit more solar heat in winter than in summer.

A west-facing window on a summer's afternoon has an angle of incidence from near 0° up to 30°, depending on latitude, with a large effective area of solar radiation. A north-facing window in summer has a high angle of incidence and a low solar irradiation striking the window area, so can transmit less heat than a west-facing window.



In temperate and cool temperate climates such as Adelaide, Hobart, Melbourne, Perth and Sydney, northerly glazing should have a high SHGC. This is standard passive solar practice for these climates. North-facing windows are a home's solar collectors. However, these windows should also have fixed shading designed to shade as little of the glass in winter as possible, while shading as much as possible in summer (see [Chapter 10](#)).

It is a common misconception that north-facing windows should be clear and single glazed to obtain the best house energy rating. Maximising passive solar gain does not necessarily lead to the lowest annual heating energy load. Low-emissivity (low-e) double glazing with high solar transmission can often provide a better annual result because the small drop in solar gain is outweighed by the lower U-value of the insulating glass. In net terms, the low-e double glazing can return a significantly lower annual heating energy load while providing superior thermal comfort (see [Section 8.2.1](#)).

The Your Home website provides further information in the glazing section at www.yourhome.gov.au.

8.2 Window elements

The elements that make up a total window system include glazing type, frame material and operating type. These elements work together to contribute to the window performance values.

8.2.1 Glazing type

Glazing type refers to the type of glass in the window system. Different types of glazing will affect the performance values of a window. The thickness of glass has negligible impact on its U-value and SHGC; however, it does have a significant effect on noise transmission and the strength of the glazing. Many other types of glass are also available to improve impact resistance such as laminated glass and toughened or safety glass. The key types applicable to modelling in NatHERS software tools can be divided into these main categories:

- **Clear glass** refers to a single pane of standard manufactured glass.
- **Obscure glass** generally describes rolled glass with a pattern embedded into its surface. Patterns can vary and are typically used as a form of decoration or for added privacy in bathrooms. (See [Section 8.4.2](#))
- **Tinted glass** has colouring additives included during manufacture. It is available in various colours, usually bronze, grey, blue and green. The different colours provide different SHGCs. The tinting does not change the U-value of the glass as glass conductivity is unaffected by the presence of a pigment in the glass.
- **Low-emissivity glass** (commonly known as low-e glass) has either a vacuum-deposited thin-film metal coating or a pyrolytic coating. As vacuum-deposited coatings are soft, for protection and longevity they must only be applied inside an insulating glass cavity. Pyrolytic coatings are baked onto the surface in the factory while the glass is still hot, to make it hard and durable.
 - The key purpose of applying low-e coating is to control the impact of heat transmitted through the glass. High transmission/low-e glass has a coating that allows daylight and solar heat gain to pass into the house, while reducing the amount of long wavelength infrared heat from escaping from the dwelling. This type of low-e is generally clear and mainly beneficial in colder climates to capture maximum solar heat gain within the dwelling.
 - Low transmission/low-e glass has a coating that allows daylight to pass into the house while reflecting long wavelength infrared heat to reduce the amount of solar heat gain into the dwelling. This type of low-e is generally grey or tinted and primarily of benefit in warmer climates to reduce solar heat gain from entering the dwelling.
 - The thermal values of low-e glass will differ depending on which surface within the glazed unit the coating is applied to. [Figure 8-2](#) shows an example of low-e coating on the inside of the external pane of a double-glazed window but it could be applied to either surface inside the window cavity or to the interior surface of the glazing. For single-glazed units it would be applied on the internal surface of the glazing.

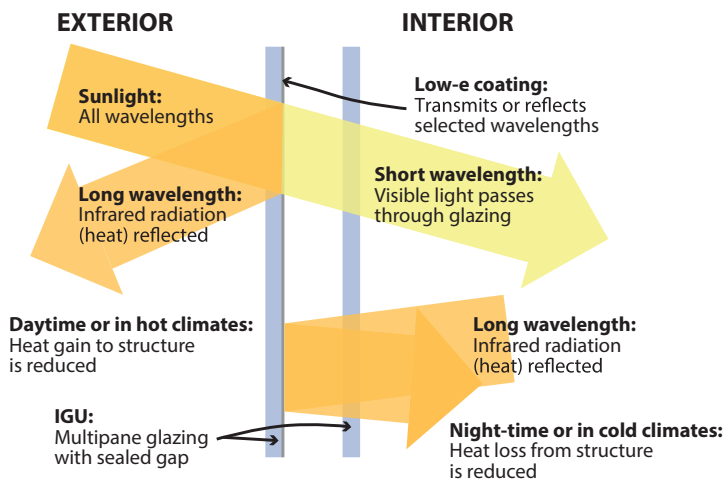

Figure 8-2: Low-emissivity coated glass to reduce solar heat gain

- Insulated glass units (IGUs)**, also known as double- or triple-glazed products, are the combination of two or three glazing panes sealed with a gap between the panes (Figure 8-3). The performance of IGUs depends on the properties of each pane of glass, the width of the cavity, the seal type and the gas (air or argon) in the cavities between the glass layers. IGU cavities may be filled with air or an inert, low-conductivity gas such as argon or krypton. IGUs with argon-filled air gaps give the best performance as argon is a denser gas and reduces the heat loss by slowing down convection of air inside the air gap. Cavity thickness usually ranges from 6mm to 18mm. Wider cavities provide lower (better) U-values, with 12mm normally accepted as the preferred gap. Triple-glazed units have a better U-value than double-glazed units because of the extra air gap and layer of glass, however they generally tend to have lower SHGC values.

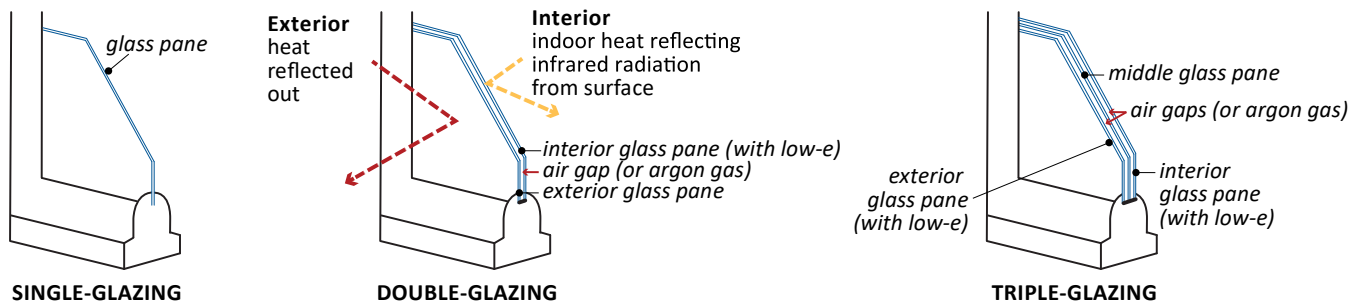

Figure 8-3: Comparison of composition between single, double and triple glazing

8.2.2 Frame material

After glazing, the frame material has the greatest effect on the thermal performance of windows. For example, aluminium frames are more conductive than timber frames and will transfer cold or heat from the outside of the frame to the inside of the room. This will be reflected in their U-value. Frame material options in NatHERS are generally divided into six main categories:

- Aluminium frames are light, strong and durable, with a variety of powder-coated and anodised finishes. However, aluminium is a good conductor of heat or cold and can decrease the insulating value of a glazing unit. Aluminium frames, especially dark coloured ones in full sun, absorb a lot of solar heat and conduct it inside, while during cold weather they can conduct the cold inside and cause condensation. Aluminium window and door frames can decrease the insulation value of the glazing unit.

8. WINDOWS AND DOORS

- Thermally broken aluminium frames are light, strong and durable, with a variety of powder-coated and anodised finishes. They have a thermal break to separate the exterior and interior pieces of the frame, using a low-conductivity component (typically urethane or other low-conductivity polymers). This reduces the heat or cold from being conducted through the frame.
- Timber frames are a good natural insulator but they require larger tolerances in openings to allow for the natural expansion and contraction of the timber. This can result in gaps that allow air infiltration, unless good draught sealing (weather stripping) is installed. They also require regular maintenance to ensure their durability, and the timber species must have naturally high durability or be treated to prevent decay and deformation.
- uPVC (unplasticised polyvinyl chloride) frames are light, durable, low maintenance and becoming increasingly popular in Australia. Their insulating properties are similar to timber and they can be moulded into complex profiles that provide excellent air seals. Unlike aluminium, uPVC is non-conductive, meaning its use in window frames does not transfer heat. It is available in a range of opening types including tilt'n'turn.
- Fibreglass frames are not readily available in Australia at present but are common overseas. They are made of glass-fibre-reinforced polyester or other fibreglass composites, which gives them strength, durability and a low U-value. Some fibreglass frames have hollow cavities within the frame that can be filled with insulation for higher thermal performance compared with timber or uPVC.
- Composite frames are manufactured using two or more different frame materials. For example, these frames could use thin aluminium profiles on the outer sections with a timber inner section. These can combine the low maintenance and durability of aluminium with improved thermal performance.

8.2.3 Operating type

Windows and doors come in a wide range of operating types, styles and configurations that affect the thermal performance of a dwelling in several ways. For example, different styles provide different opening areas, which determine how much cross-ventilation can be gained.

Window and door information needs to be obtained before modelling a dwelling. If the documentation only includes window and door sizes and locations, and the glass and frame type and/or opening style are not specified, a NatHERS Certificate should not be finalised. (**Tech Note clause 3.3**). This information is required for modelling either default or custom windows. See [Section 8.3.1](#) and [Figure 8-5](#) for more information on some of the standard default window operating type classifications.

8.3 Window libraries

- 8a** When modelling windows or glazed doors, assessors must use the Australian Fenestration Rating Council (AFRC) custom window codes corresponding to the windows specified in the design documentation or the WERSLink default window library or NatHERS default window libraries. (**Tech Note clause 8.3**).

WERSLink

In 2022 the Australian Glazing and Window Association (AGWA) WERSLink online portal was completed (wers.net). WERSLink will underpin the new WERSLink default and custom window libraries.

The WERSLink libraries will improve the way assessors can model windows by, for example, providing more accurate and consistent products and data. The window databases will be managed and provided to the NatHERS software providers by the AGWA.

The libraries will be available in NatHERS software using Chenath 3.23. See [Sections 8.3.1](#) and [8.3.2](#) for more information.



8. WINDOWS AND DOORS

8.3.1 Default window libraries

Assessors can select default windows from two databases: the NatHERS default window library and the WERSLink default window library.

WERSLink default window library (DWL) database

The WERSLink DWL database was developed to create a better representation of windows that are available on the market for selection and substitution in NatHERS software tools. The library will run alongside the existing NatHERS DWL in software using Chenath 3.23.

Windows from the WERSLink DWL can be used when the window manufacturer or supplier is not detailed in the documentation. The WERSLink DWL can also be used if the window manufacturer or supplier has been specified in the documentation but the specific window required is not available in the custom windows library.

There are 1,279 windows available in the WERSLink DWL, representing common window styles and materials. Selection of the WERSLink DWL was guided predominantly by U-value and SHGC value from more than 40,000 commercially available 'real-world' products.

WERSLink default window codes

A coding convention was created for NatHERS software WERSLink DWL. Each default window consists of an 11-letter alpha-numerical code (see [Figure 8-4](#) below). This code is for NatHERS software tool identification only and is not a code used to order windows from a builder or windows supplier.

Each code is unique according to the parameters described below and shown in [Figure 8-4](#) and [Table 8-1](#):

- The first letter of the code represents the library from which the default window is being selected.
- The second letter represents the frame material.
- The third and fourth letters represents the window operating type.
- The fifth letter represents the glazing type.
- The first three digits represent the U-value of the window with the decimal point falling after the second digit, e.g. 060 = 06.0.
- The last three digits represent the SHGC with the decimal point falling after the first digit, e.g. 051 = 0.51.

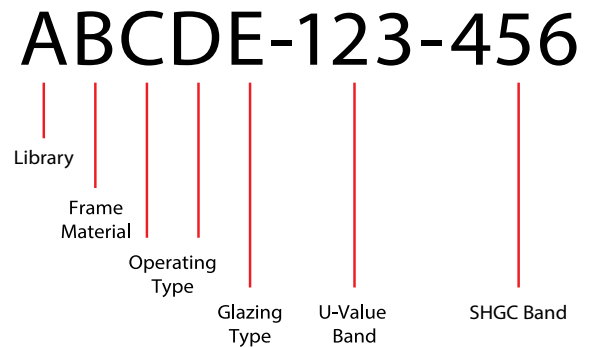

Figure 8-4: WERSLink default window code example

See [Section 8.2.2](#) for more information on frame types and [Section 8.2.1](#) for more information on glazing types.

Table 8-1: WERSLink default window code abbreviations

Library	Frame Material	Operating type	Glazing Type
H = Housing A = Apartments	A = Aluminium B = Thermally Broken Alum C = Composite P = uPVC T = Timber	AW = Awning BD = Bifold Door CW = Casement Window FW = Fixed Window FD = French Door HD = Hinged Door LW = Louvre Window SD = Sliding Door SW = Sliding Window TW = Tilt'n'turn Window WW = Window Wall	S = Single Glazed D = Double Glazed T = Triple Glazed

8. WINDOWS AND DOORS

As shown in example 1 and 2 below, the first part of the coding convention divides the WERSLink DWL into two categories, one for Class 1 (Housing) and one for Class 2 (Apartment) dwellings. For the purposes of NatHERS assessments only, apartment windows are defined as ones in buildings 15m (6 storeys) high or higher and installed using sub-frames.

The apartment category was created due to the different types and sizes of windows found between Class 1 and Class 2 dwellings. For example, there is generally a wider variety of frame material options and operating types in windows for Class 1 dwellings compared to Class 2 dwellings. Class 2 windows are generally bigger, have a lower frame fraction than average Class 1 windows and feature a higher proportion of sliding doors. They also need to contend with higher wind loads and are therefore stronger.

Example 1:

HAAWS-060-051

- Housing
- Aluminium
- Awning
- Window
- Single Glazed
- U-value = 6.0
- SHGC = 0.51

Example 2:

AASDD-045-042

- Apartment
- Aluminium
- Sliding
- Door
- Double Glazed
- U-value = 4.5
- SHGC = 0.42

A breakdown of the number of each window frame type included in the WERSLink DWL is as follows:

Housing:

- Aluminium – 429
- Thermally Broken Aluminium – 175
- uPVC – 164
- Timber – 155
- Composite – 111

Total = 1,034

Apartments:

- Aluminium – 158
- Thermally Broken Aluminium – 87

Total = 245

NatHERS default window library (DWL) database

The NatHERS DWL is available in all software tools. Windows from the NatHERS DWL can be used when the window manufacturer or supplier is not specified in the documentation. The NatHERS DWL can also be used if the window manufacturer or supplier has been specified in the documentation, but the specific window required is not in the range of windows available in the NatHERS custom window library. However, in this situation, it may be more accurate for the assessor to choose an appropriate custom window substitution (**Tech Note clause 8.5**).

There are 136 NatHERS default windows in the database available in NatHERS software, comprising six frame types and 12 glazing types. These default windows were originally developed by analysing more than 10,000 custom windows from the AFRC database of frame types, glazing combinations and operating type. Therefore, the default window performance values do not represent actual windows on the market but are only a statistical representation of products available.





8. WINDOWS AND DOORS

NatHERS default window groups and operating types

Default windows are divided into two groups based on their operating type (see [Section 8.2.3](#)), predominantly to account for the effect this has on the frame fraction of the window/door. Frame fraction refers to the ratio of frame to glass in a fenestration product. Having two groups of windows accommodates the large variations in frame fractions across the products that were derived from the statistical analysis.

Group A and B type windows are the NatHERS terminology used to define which default window should be selected for a specific openable sash. A and B type default windows do not necessarily align with window IDs in NatHERS software tools and have no association or significance to AFRC ratings or window manufacturers.

Table 8-2: Group A and B type windows descriptions

	Group A – windows and doors with a larger frame fraction such as awning windows, bifold windows and doors, casement windows, tilt'n'turn windows, entry doors, French doors and hinged doors.
	Group B – windows and doors with a smaller frame fraction such as fixed windows, double-hung windows, louvre windows, sliding windows and doors, and stacker doors.

[Figure 8-5](#) (below) provides a visual representation of these windows and their corresponding window group types.

Each group has representative performance values (U-value and SHGC) each with a U-value derived at the 75th percentile of the sample of rated windows and doors that were analysed. The SHGC values are the adjusted median from the same sample of rated windows and doors; 50% have a SHGC value less than the default value and 50% have a value greater than the default value.

8. WINDOWS AND DOORS

Awning

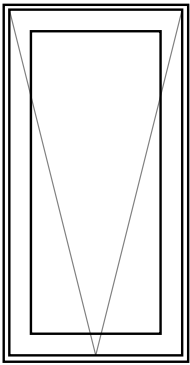

Awning windows have one or more sashes that are hinged at the top and open outwards.

Casement or hinged

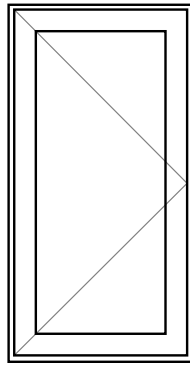

Casement windows have one or more sashes that are hinged at the side and can open outwards or inwards.

Bifold

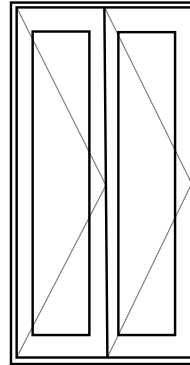

Bifold windows have two or more sashes. The first sash is hinged to the window jamb and subsequent sashes are hinged to the preceding sash and open outwards.

Tilt'n'turn

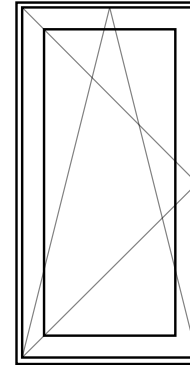

Tilt'n'turn windows have complex hinging which enables the casement sash to open inwards from the side or be tilted inwards from the bottom.

Fixed

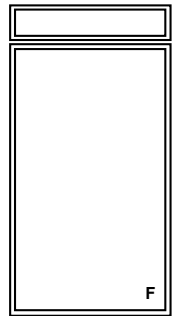
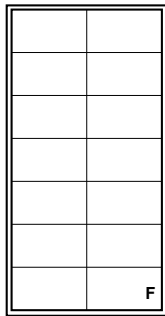
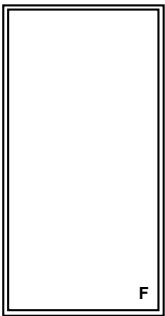

Fixed windows have no operable components and may be divided by mullions and transoms.

Double hung

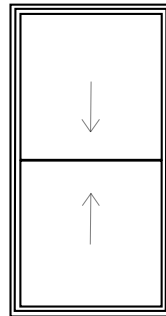

Double hung windows have two sashes that slide vertically. They can also be single hung, in which the top or bottom sash is fixed.

Tilt'n'turn

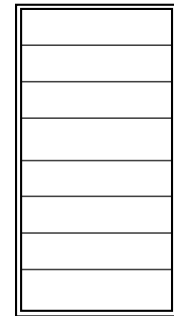

Louvre windows have multiple moveable glass panels or blades that pivot horizontally.

Sliding

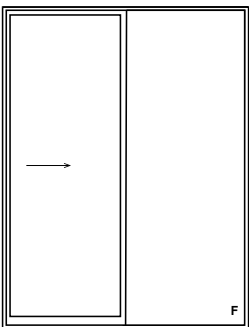

Sliding windows and doors have one or more horizontal sliding sashes.

French doors

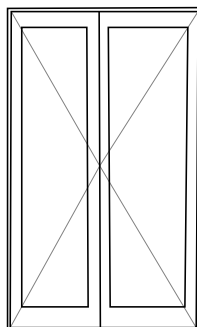

French doors have two hinged door panels and open inwards or outwards.

Stacker doors

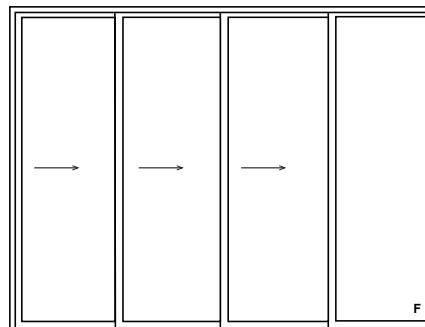

Stacker doors have two or more sliding panels that, when fully open, cover the fixed panel, or the fixed panels are not visible because the doors slide into a wall cavity.

Figure 8-5: NatHERS default window and glazed door operating types



8. WINDOWS AND DOORS

NatHERS default window codes

The NatHERS DWL uses a different coding convention to that used in the WERSLink DWL. Each default window in the NatHERS DWL consists of a nine-letter alpha-numerical code. This code is for NatHERS software tool identification only and is not a code used to order windows from a builder or windows supplier. Each code is unique according to the following parameters:

The first three letters of the window code represent the frame material of the default window:

- ALM – aluminium
- ATB – aluminium thermally broken
- TIM – timber
- uPVC – unplasticised polyvinyl chloride
- CMP – composite (these can be aluminium and timber, uPVC and timber, or uPVC and aluminium)
- FIB – fibreglass.

See [Section 8.2.2 Frame material](#) for more information on each frame type.

The first three numerals of the window code represent the group the default window is assigned to, the type of glazing (single or double glazing) and the type of air gap (air or argon):

- 001 – Group A single glazing
- 002 – Group B single glazing
- 003 – Group A double glazing with air fill
- 004 – Group B double glazing with air fill
- 005 – Group A double glazing with argon fill
- 006 – Group B double glazing with argon fill.

The last two numerals indicate the coating of the glass:

- 01 – clear
- 02 – tint
- 03 – high solar gain low-e (HSG low-e)
- 04 – low solar gain low-e (LSG low-e).

In NatHERS software, HSG and LSG refer to high and low SHGC respectively. See [Section 8.2.1](#) for more information on each glazing type.

The last letter is used by the Chenath engine when the frame material rating is calculated in the simulation process:

- A – aluminium frame with no thermal break
- B – aluminium frame with thermal break
- I – composite frame
- W – uPVC, timber or fibreglass frame.

For example, a window with an aluminium frame and Group A single clear glazing would have a code of ALM-001-01-A, and a timber awning window with double glazing and argon fill with HSG low-e would have a code of TIM-005-03-W. A full list of the current default windows is in [Table 8-2](#) in Section 8.7.

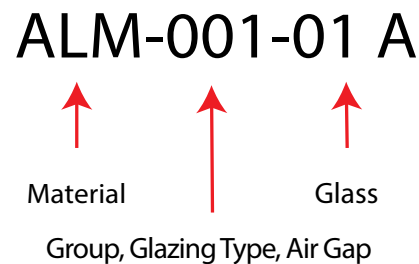

8.3.2 Custom window libraries

WERSLink custom window library

Custom windows from the WERSLink custom window library are used when:

- the window manufacturer or supplier and actual window specifications are included in the window schedule and/or documentation
- there is a request from the client for a particular window manufacturer or supplier, and actual window specifications and updated documentation to specify this has been received
- the assessor recommends window values or characteristics (e.g. U-value and SHGCw values) to demonstrate an improvement in the thermal performance of the dwelling. In this case, the client must agree to the change and provide revised documentation to include these details before the assessor produces the NatHERS Certificate.

WERSLink custom window database

The WERSLink custom window database will update the way window data is created, managed and distributed, and will improve the way assessors can model custom windows, e.g. by providing more accurate and consistent products and data. The WERSLink custom window library will become available in software using Chenath 3.23. The WERSLink custom window databases will be managed and provided to NatHERS software providers by the Australian Glass and Window Association (AGWA).

WERSLink custom windows are manufactured window products available on the Australian market that have been tested and approved using the AFRC protocols. Each custom window is a unique product, which includes the performance values for the frame material, the operating type and the glazing. The product data in the WERSLink custom window library will replicate what is currently in the NatHERS custom window library and include additional products as they become available.

Depending on software implementation and user interface development, selection of windows from the WERSLink custom window library may be able to be filtered by a variety of parameters, including manufacturer, operating type, glass type or frame type. An indication of filtering options that may be applied in NatHERS software can be found at wers.net. Assessors should refer to their relevant NatHERS software manual for more information on how to model WERSLink custom windows in NatHERS software when it becomes available.

WERSLink custom window codes

Each product in the WERSLink custom window library consists of a nine-letter alpha-numerical code. These codes are for the software to read and cannot be used to order windows. Each code is unique to the product:

- The first three letters represent the manufacturer's three-letter abbreviated name.
- The first three numerals represent the product ID.
- The last three numerals represent the glazing type.

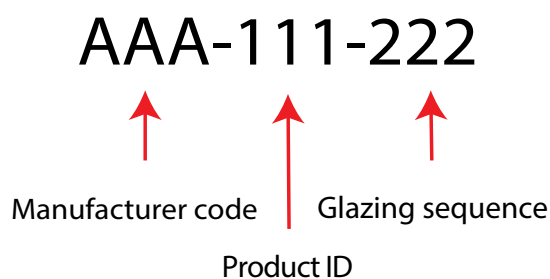

WERSLink custom window substitution

8b If the software is using the WERSLink custom window library and a window is specified on the design documentation that is not available, an assessor must choose a default window from either the WERSLink default window library or the NatHERS default window library with the specified opening type as per **Tech Note clause 8.4**.

Substitution rules for WERSLink custom windows can apply at the building certifier stage when a window installed is within the defined parameters from the one used in the assessment. This is specified on the NatHERS certificate as a total window system Solar Heat Gain Coefficient (SHGCw) $\pm 5\%$ of the window specified in the documentation.

8. WINDOWS AND DOORS

Updates to the WERSLink custom window database

AGWA has committed to regularly updating the WERSLink custom window library with new products. The timing of updated versions of the WERSLink custom window library for each software tool is agreed between the NatHERS administrator and the software tool developer.

NatHERS custom window library

Custom windows from the NatHERS custom window library are used when:

- the window manufacturer or supplier and actual window specifications are included in the window schedule and/or documentation
- there is a request from the client for a particular window manufacturer or supplier, and actual window specifications and updated documentation to specify this has been received
- the assessor recommends window values or characteristics (e.g. U-value and SHGCw values) to demonstrate an improvement in the thermal performance of the dwelling. In this case, the client must agree to the change and provide revised documentation to include these details before the assessor produces the NatHERS Certificate.

NatHERS custom window database

NatHERS custom windows are manufactured window products available on the Australian market that have been tested and approved using AFRC protocols and are (or were) listed on WERS database. Each custom window is a unique product, which includes the performance values for the frame material, the operating type and the glazing.

Assessors should note that not all windows/doors available on the market in Australia are included in the NatHERS custom window library. Additionally, assessors may notice that the manufacturer's full range of products is not listed in the NatHERS custom window library. See 'NatHERS custom window substitution' (below) for more information on modelling requirements in these situations.

The NatHERS custom window library is managed and provided to NatHERS software by the AFRC and is based on WERS ratings. The main difference between the AFRC and WERS databases is that the AFRC one is formatted for use in NatHERS software and the WERS one is consumer based and formatted for online viewing. Assessors should refer to their relevant software manual for more information on how to model custom windows.

Note: Although efforts are being taken to ensure alignment between the AFRC and WERS databases, there may be times where specific windows are in the online WERS database but not yet available in the AFRC database used in NatHERS software.

NatHERS custom window codes

Each AFRC-rated product in the custom window library consists of a nine-letter alpha-numerical code. These codes are for the software to read and cannot be used to order windows in the WERS database or anywhere outside NatHERS software. Each code is unique to the frame, operating type and glazing:

- First three letters represent the manufacturer's three-letter abbreviated name.
- First three numerals represent the frame type.
- Last two numerals represent the glazing type.
- Last letter represents the frame material code within the software and must not be used as a stand-alone selection tool.

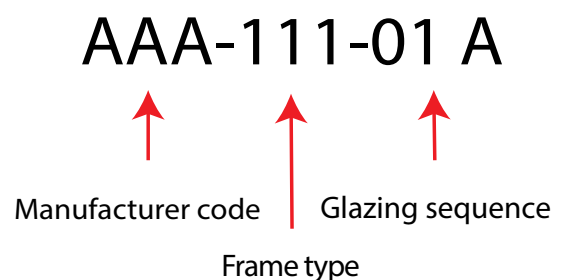

NatHERS custom window substitution

A requirement outlined in the NatHERS Technical Note allows assessors to substitute custom windows from the NatHERS custom window library. This rule improves modelling of windows in NatHERS software, while the NatHERS Administrator continues to actively work with AGWA, AFRC and NatHERS software tool providers to ensure the best outcome is achieved.

Assessors can apply this when the window specified is not available in the NatHERS custom window library. This can also cover substitution at the building certifier stage when a window installed is different (but within the outlined parameters) from the one used in the assessment.

8c If the specified custom window is not available in the NatHERS custom window library, assessors must model a default window from the NatHERS default window library with the specified opening type or an available custom window that meets all the parameters outlined in **Tech Note clause 8.5**. Substituted values must be based on the Australian Fenestration Rating Council (AFRC) protocol rather than, for instance, the European ratings.

Substituted values must be based on the Australian Fenestration Rating Council (AFRC) protocol rather than, for instance, the European ratings.

This allows flexibility to model a different custom window to that specified if these specific parameters are met (i.e. same opening type, a U-value equal to or greater than, and an SHGCw +/-5%). During construction, certifiers will be checking the custom window type, size and details (i.e. SHGCw, U-value) to confirm compliance.

Updates to the NatHERS custom windows database

The AFRC updates the NatHERS custom window library files with new products in collaboration with NatHERS software providers. The timing of updated versions of the window library files for each software tool is agreed between the NatHERS administrator and the software tool developer. For more information about the update schedule, assessors should contact the relevant software tool provider.

Note: To prevent duplication of custom window product data the WERSLink custom window library will replace the NatHERS custom window library in software using Chenath 3.23. Refer to the WERSLink custom window database subheading above.



8.4 Entering windows into software

To enter windows and glazed doors into NatHERS software, details about their glass type, frame material, operating type, openable percentage, size and location need to be noted in the documentation. This information is required for modelling either default or custom windows. Assessors will also need to select each window from either the default or custom window library (see [Section 8.3](#)).

8d The minimum design documentation required when modelling windows and glazed doors should comprise window, skylight, roof window and door details, including size, glass type, frame type, openable percentage, opening style and location. (**Tech Note clause 2.5**)

If any of these basic window/door details are not specified, the documentation must be referred to the client for clarification. The documentation must be updated to include the necessary information before the NatHERS assessment is completed. (**Tech Note clauses 3.3, 3.4 and 3.5**)

Assessors should note that the methods of modelling default windows from the NatHERS DWL in NatHERS software tools are for the purposes of NatHERS simulation and assessment only and not representative of specific window products. Modelling windows from the WERSLink DWL, available in software using Chenath 3.23, is representative of real-world products.

8.4.1 Size

Given window/door specifications may have a significant effect on a dwelling's thermal performance and are available in a large range of sizes, it is essential that the correct sizes are entered. It is therefore essential for assessors to check that the sizes of each window/door are included in the documentation before commencing a NatHERS assessment. The size modelled must be the overall window size including the frame (e.g. not just the dimensions of the opening component or glazing area). This information is required to be modelled regardless of whether default or custom windows are used.

8.4.2 Glass and frame types

Specific window information is required to be documented when assigning a default window. The information needed is the glazing type (single or double glazed), the gas (air or argon) in the gap between glass panes, the coating of glass (clear, tint, LSG low-e or HSG low-e) and the specified frame type, which consists of the material of the frame (aluminium, timber, uPVC, composite) and whether the frame is thermally broken. This information is always required; however, these window/door details can be included in the documentation as general values (for use with default windows) or can be specific manufacturer window specifications (for use with NatHERS or WERSLink custom windows). If the information is unknown, assessors must request updated documentation, including these specifications, before starting an assessment. (**Tech Note clause 3.5**)

Obscured glass (frosted, fritted, film) is classified as a complex glazing system, which is not yet approved internationally through the National Fenestration Rating Council (NFRC). Therefore, the Australian Fenestration Rating Council (AFRC) cannot obtain WERS ratings for these types of products at the moment.

8e When using any default windows, obscure glass (for instance, in a bathroom or WC) may be considered as either clear if the glass is clear patterned, or tint if the glass is a tint or translucent laminate. (**Tech Note clause 8.6**)

8f In the absence of obscure glass in the custom window libraries, assessors must model either a default clear window if the glass is clear patterned, or a default tint window if the glass is a tint or translucent laminate. If the glass is clear patterned, then a clear window from the same range of custom windows that is being used (i.e. same frame type and frame material) must be modelled. If the glass is tint or translucent laminate, then a tint window from the same range of custom windows that is being used (i.e. same frame type and frame material) must be modelled. (**Tech Note clause 8.7**)

Similarly with any custom windows, assessors may model a default clear window but also have the option to model a clear window from the same range of custom windows that is being used (i.e. the same supplier, same frame type and frame material).



8. WINDOWS AND DOORS

Complex glazing systems may be approved internationally through the NFRC and subsequently the AFRC in the future, allowing products such as obscure glass to be better incorporated into the NatHERS software and the energy assessment.

8.4.3 Location and offset

Assessors must ensure that the location of windows/doors is modelled to align with the documentation by accurately entering the locations and head heights shown on the floor plan(s), window/door schedule, specifications and elevations into the NatHERS software.

Offset refers to the positioning or dimension in the documentation that indicates where the window/door is located along a wall. For example, the window may be 250mm from the end of the wall or external dwelling corner. Refer to the relevant software tool manual for more information on correctly modelling windows/doors. This information is always required and is not affected by whether the assessor is using default or custom windows.

8.4.4 Opening style and openability

Opening style refers to the type of opening of the window/door (e.g. awning, casement, sliding) and is required for any default or custom windows. Openability (or opening percentage) refers to the percentage of the area of the window that can open – not how far the window can open for the user – and relates to ventilation rates in the NatHERS simulation.

[Table 8-3](#) lists the typical opening percentages used in NatHERS software, which are applicable to both default and custom windows. Where a complying security screen is absent, assessors must adjust window opening percentages to meet restricted opening safety requirements. If the restricted opening percentage is not specified on the design documentation where they are required, assessors must use the default opening percentage of 10% for all openable window types.

Even if a window can open fully, the opening percentage will not be 100% as the frame that remains when the window is open is deducted from the full size of the window and creates an area of available ventilation.

8g When using the NatHERS default window library, assessors must apply the default openable percentages listed in [Table 8-3](#). (**Tech Note clauses 8.8 and Table 4**)

[Table 8-3](#) lists the default window/door opening percentages that assessors must use when using any default windows in assessments or if the opening percentage for any custom windows cannot be determined from the manufacturer's ventilation charts. These percentages equate to openability and frame fraction considerations that relate to ventilation in Chenath engine simulations.

8h When using any custom windows, assessors must use the manufacturer's ventilation charts to determine the openability of the window/door. If this information is not available, apply the default percentages listed in [Table 8-3](#). (**Tech Note clauses 8.8 and Table 4**)

When modelling any custom windows, manufacturer's ventilation charts must be used to calculate window/door openability. Manufacturer's ventilation data may give an opening percentage of total window size but more commonly they will give square metres of total window size and total openable area. This can then be used to determine the available ventilation percentage.



8. WINDOWS AND DOORS

Table 8-3: Default window opening percentages (Table 4 of NatHERS Technical Note)

Type	Default opening percentage
Fixed	0%
Operable component	
WITH restricted opening safety requirements	
All window types shown with safety restrictors (Tech Note clause 8.11)	10%
WITHOUT restricted opening safety requirements	
Double hung	45% ²
Sliding	45% ³
Awning	90%
Casement/tilt'n'turn	90%
Louvre	90%

Section 8.4.5 gives examples of how to manually calculate the openability of combination window configurations or when combining similar windows for modelling.

8.4.5 Combining NatHERS default windows

The preferred method to accurately model the impact of windows in NatHERS software is to enter each window component separately. However, since this is not always practical, a NatHERS default window with multiple glazing components can be entered as a single window if certain parameters are met.

If all the window components have the same default window opening percentage the combination window would be modelled as a single window using the corresponding default window opening percentage. For example, the combination windows below would be modelled as a single window with an opening percentage of 90% (Table 8-3, Tech Note clause 8.8 and Table 4).

In Figure 8-6 below window 01 is two awning windows while window 02 is a tilt'n'turn window and a casement.

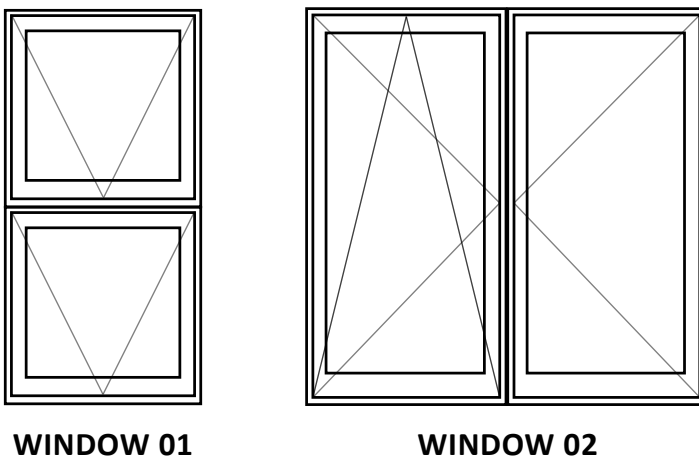

Figure 8-6: Examples of the opening percentage of combined windows

2 Two window sashes where the movable sash, or sashes, can open a maximum of 45% of the entire window
 3 Sliding window or door where the movable sash opens a maximum of 45% of the entire opening

8. WINDOWS AND DOORS

8.4.6 Combining complex NatHERS default windows (**Tech Note clause 8.10**)

When assessors are faced with windows with multiple glazing components and opening types these may be entered into the NatHERS software as a single window by calculating the windows' total opening percentages, as shown in the equation below.

$$(a \div b) \times 100 = c\%$$

where:

a = the sum of each openable glazing component's area multiplied by its corresponding default opening percentage (Table 8-3, **Tech Note clause 8.8 and Table 4**)

b = the total area of the combined window

c = the percentage openability of the single (combination) window

Note: This formula can be applied to any configuration of combination window with both fixed and openable components to calculate total opening percentage. For example, the combination window below shows one awning and one fixed glazing component.

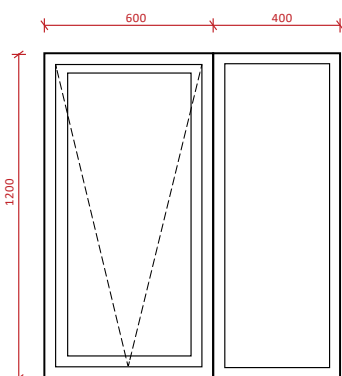

This combination window can be modelled as a single window with an openability calculated as follows:

Step 1. Find 'a'. Sum all of the windows openable component areas and multiply by the default window opening percentages from Table 8-3. For this example, the awning is the only openable component therefore:

$$\text{Awning window area} = 0.6 \times 1.2 = 0.72\text{m}^2$$

$$\text{Default opening percentage of awning window} = 90\% (0.9) \text{ (Table 8-3, Tech Note clause 8.8 and Table 4)}$$

$$\text{Area of openability of the awning window component} = 0.72 \times 0.9 = 0.648\text{m}^2$$

$$\text{The total area of openability of the combination window is } \mathbf{a = 0.648\text{m}^2}$$

Note: if there is more than one openable component to a combination window, these areas would be added together in this step but this is not relevant to this example as there is only one openable component.

Step 2. Find 'b' the area of the single (combination) window

$$\mathbf{b = 1.2 \times 1 = 1.2\text{m}^2}$$

Step 3. Find 'c' the total combination windows opening percentage using the formula

$$(a \div b) \times 100 = c\%$$

$$\mathbf{a = 0.648\text{m}^2} \text{ (from Step 1)}$$

$$\mathbf{b = 1.2\text{m}^2} \text{ (from Step 2)}$$

$$\mathbf{c = (0.648 \div 1.2) \times 100 = 54\%}$$

Therefore, this combination window's total opening percentage is **54%**



8. WINDOWS AND DOORS

Assessors should ensure the actual location of each window component in the parent wall is accurate and each component has a correct head height and vertical and horizontal offsets within the wall. This will ensure factors such as vertical and horizontal shading and air flow are correctly applied.

It is important for assessors to note that this method of combining NatHERS default windows is for NatHERS modelling purposes only. They are not to be used for ordering windows, nor are they representative of compliance with the NCC, or realistic window construction/installation methods.

- 8j** All unconditioned external garage doors must be modelled as not weather-stripped and all unconditioned garage windows must be modelled as not weather-stripped with insect screens, unless otherwise specified in the design documentation. All conditioned external garage doors must be modelled as weather-stripped and all conditioned garage windows must be modelled as weather-stripped with insect screens, unless otherwise specified in the design documentation. (**Tech Note clause 8.1**)

8.5 Doors

In NatHERS software simulations, doors and windows allow for air movement. They are assumed to be opened and closed, as appropriate, to allow the dwelling to be naturally ventilated. Ventilation benefits are taken into account when the software calculates the energy load required for mechanical heating/cooling.

8.5.1 Non glazed doors

It is important that all doors in a dwelling are modelled accurately, including their size and location, because they contribute to both air movement and zoning of the dwelling. Where the door is solid with no glazing elements, there are options in NatHERS software to enter internal and external solid doors where specified in the documentation. Assessors must refer to the relevant software tool manual for more information.

8.5.2 Glazed doors

Doors that include glazing elements should be accurately captured in the assessment. If modelling a fully glazed hinged or pivot door, the appropriate door should be selected from either the default or custom window libraries. If the custom window library or the WERSLink default window library has a glazed hinged door, assessors must use that window product code. Otherwise, it is entered as a Group A casement window from the NatHERS default window library with the appropriate default window code for the frame type and glazing.

If the documentation includes an internal glazed door, it is to be modelled as a solid internal door in NatHERS software. This is because the Chenath engine does not currently treat these as a glazing component (or glass wall) and solar transmission is not taken into account or applied.

- 8i** The glazed portion of a fully or partially glazed door is modelled as a window in NatHERS software tools. If the glazed component is less than 25% of the door, the door may be modelled as a solid door. (**Tech Note clause 8.2**) Assessors should refer to their relevant software tool manual for guidance.



For partially glazed entry doors, assessors should model the glazing effect when the glazed component equates to 25% or more of the door. When modelling these types of doors, a suggested method is to enter a solid door (adjusting the door height/width to not include the glazing component) and then model the glazing component as a separate window. The combined door and glazing size should align with the door size detailed in the documentation and the glazing component is to be modelled as a Group A casement window to ensure the openability is similar to that of the parent door. If the glazed component is modelled as a fixed window, the Chenath engine will not treat the entire door as being able to open to provide ventilation.

Examples of how to model partially glazed entry door in NatHERS software are shown in [Table 8-4](#).

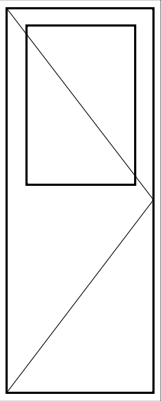
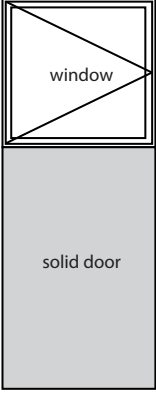
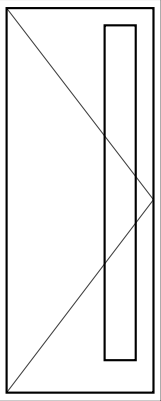
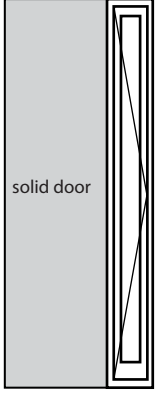
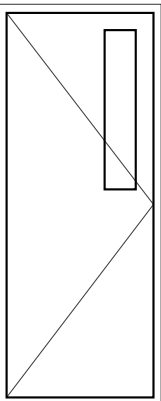

8. WINDOWS AND DOORS

Table 8-4: Examples of how to model partially glazed entry door in NatHERS software

Specified door	Modelling instructions	Modelled door
	<p>This is a half-light door. The glazing is entered as a Group A casement window and the rest of the door is entered as a solid door with the appropriate horizontal and vertical positioning of the glazing and solid door components.</p> <p>The size of the door is reduced by the total calculated glass size and the glazing is modelled separately.</p> <p>It is appropriate for the casement window component modelled to have the same opening percentage to align with the assumptions of an openable door (i.e. 100%). This is only to be edited when modelling a partially glazed door component and is not appropriate when modelling a window that is located next to the door.</p>	
	<p>This is a partially glazed door. Since the glazing component equates to greater than 25% of the door size the door should be modelled as two individual components: a solid door with decreased width and a Group A casement window.</p> <p>The size of the door is reduced by the total calculated glass size and the glazing is modelled separately.</p> <p>It is appropriate for the casement window component to be modelled to have the same opening percentage to align with the assumptions of an openable door (i.e. 100%). This is only to be edited when modelling a partially glazed door component and is not appropriate when modelling a window that is located next to the door.</p>	
	<p>In this partially glazed door the glazing component is less than 25% of the overall door size; therefore, it can be modelled as a solid door. (Tech Note clause 8.2)</p>	

8.5.3 Glazing around doors

Openable or fixed glazing components to either side or above an entry door frame (sidelights) are entered as separate Group B default fixed windows or as custom windows. It is important to locate each glazing component in the parent wall with the applicable vertical and horizontal positioning/offset within the wall. Examples of glazing treatment for entry door sidelights are shown in [Figure 8-7](#).

8. WINDOWS AND DOORS

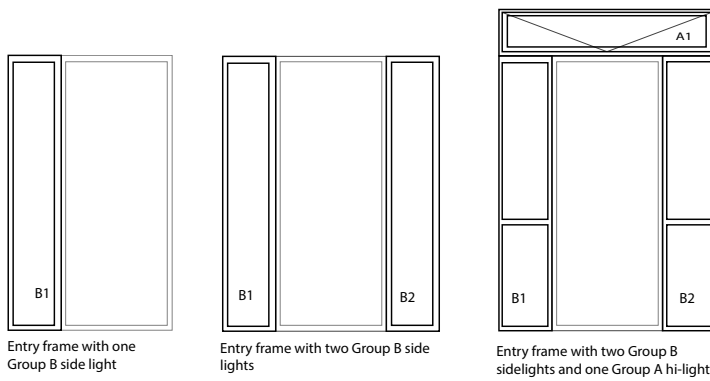

Figure 8-7: Modelling glazing around doors

8.6 Roof and high-level glazing

NatHERS software allows assessors to enter details about glazed areas in the roof and at higher levels in the walls.

Four types of glazed areas are available for roofs and at high levels as shown in [Table 8-5](#):

Table 8-5: Types of glazed areas available for roofs and at high levels

Description of glazed area type	Image of glazed area type
<p>Skylights – a glazed or Perspex element, either fixed or openable, penetrating the roof construction and connected to a zone by a shaft that passes through the roof/attic space. Some skylights may be tubular or domed, with reflective shafts.</p> <p>This definition is specific to NatHERS modelling and may differ from a broader definition of skylight characteristics and products available on the market.</p>	<p>Skylight</p>
<p>Roof windows – a glazed element in a roof that does not have a roof/attic space; it is either fixed or openable and penetrates the roof construction. Roof windows are generally pitched in alignment with the roof.</p> <p>This definition is specific to NatHERS modelling and may differ from a broader definition of roof window characteristics and products available on the market.</p>	<p>Roof window</p>
<p>Clerestory windows – a high window, either fixed or openable, in an external vertical wall to a zone. The external wall that contains the window and the clerestory window must both be modelled. They are typically fixed but may be openable to create cross-ventilation within the dwelling.</p>	<p>Clerestory window</p>
<p>Highlight windows – a glazed element located high in a wall, typically above another window or door in the same wall (see Section 8.5.3). A highlight window is entered as a window, not as roof-level glazing. This type of glazing must always be entered into the NatHERS software as it can contribute significantly to the amount of solar radiation entering the dwelling and create a path for heat to flow in and out of the dwelling.</p>	<p>Highlight windows</p>

8. WINDOWS AND DOORS

Figure 8-8 defines roof glazing terminology that may be required when inputting data into NatHERS software to model skylights or roof windows. Depending on an assessor's software tool, additional information and modelling may be required for complex scenarios. For example, a roof window modelled into an attic space may require assessors to add internal walls to the roof space for the shaft. Assessors must refer to their software tool manual or contact their Assessor Accrediting Organisation for guidance.

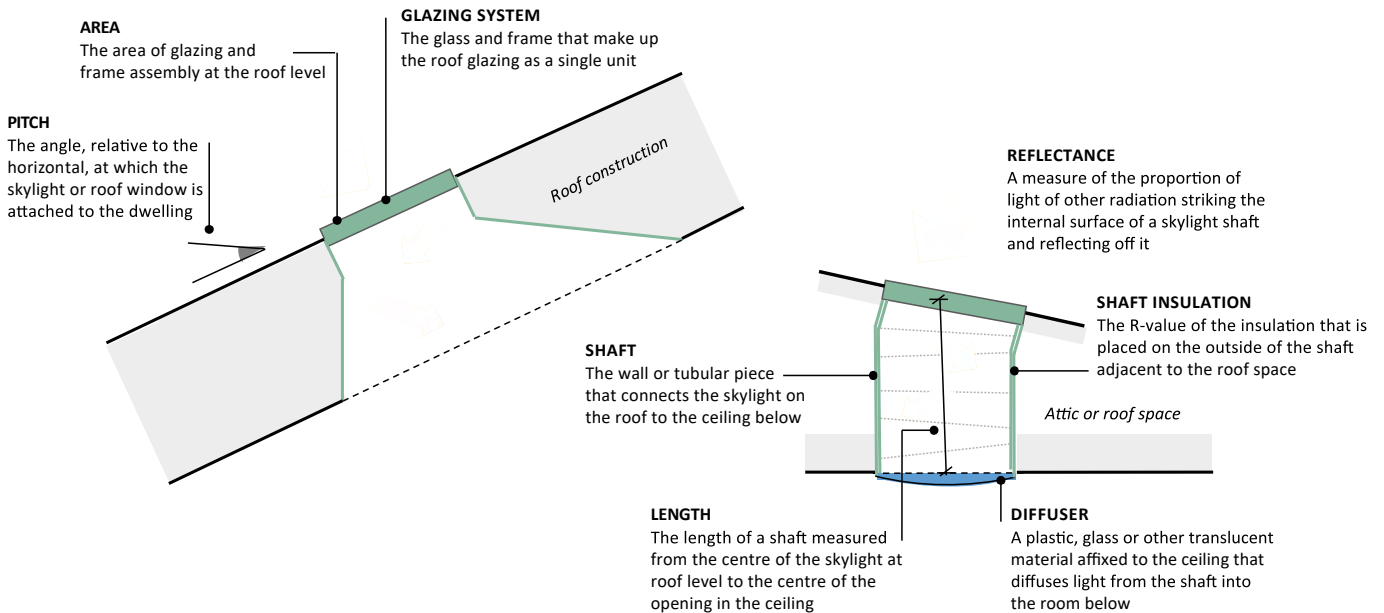

Figure 8-8: Roof glazing terminology

The relevant U-value (U_w) and SHGC_w are determined by NatHERS software based on the selection of the roof glazing system. Both default and custom window selections will apply U and SHGC values to the NatHERS simulation as appropriate. It is important to note that in NatHERS software tools, default window types must be used for all roof glazing unless there is a custom window available for the skylight or roof window product specified.

Depending on the assessor's software tool and the documentation of the skylight or roof window, they may not be able to edit all characteristics. However, assessors may want to advise clients (and recommend changes to documentation) to ensure skylight shafts are adequately insulated and that high performance glazing is used, to minimise heat loss in winter and heat gain in summer.

Depending on the NatHERS software tool, clerestory windows can be entered using a special feature or by creating additional walls with suitable height and width and adding windows to those walls. Depending on the software, there may also be restrictions on the inclusion of roof windows. Assessors should refer to the software tool manual for more information on modelling roof windows and to determine if any restrictions apply.

8.6.1 Double-height windows

When a window crosses storeys of a dwelling, such as in a stairwell or double-height void area, the entire area of the window must be modelled. Two windows with the same specifications or window code should be created, one on each of the two levels that it crosses. Depending on the software tool, assessors may or may not have to include the internal floor thickness in the modelled height of the window. This means the head height of the window on the upper level may be higher than drawn on the plans by an amount equal to the specified floor thickness.

Assessors must refer to the relevant software tool manual or windows training for modelling guidance.



8.7 List of current NatHERS default window specifications

Table 8-6 lists frame, operating and glazing types, and window performance values for all current default windows in the NatHERS DWL. The NatHERS DWL is used for both windows and glazed doors.

Table 8-6: Specifications of current default windows in NatHERS software

Type	Code	Frame and operating type (Group A or B)	Glazing descriptions	Uw	SHGCw	
Aluminium	Aluminium Group A single glazing	ALM-001-01 A	Aluminium A	Clear	6.7	0.57
		ALM-001-02 A	Aluminium A	Tint	6.6	0.41
		ALM-001-03 A	Aluminium A	HSG low-e	5.4	0.49
		ALM-001-04 A	Aluminium A	LSG low-e	5.6	0.36
	Aluminium Group B single glazing	ALM-002-01 A	Aluminium B	Clear	6.7	0.70
		ALM-002-02 A	Aluminium B	Tint	6.6	0.49
		ALM-002-03 A	Aluminium B	HSG low-e	5.4	0.58
		ALM-002-04 A	Aluminium B	LSG low-e	5.6	0.41
	Aluminium Group A double glazing air fill	ALM-003-01 A	Aluminium A	DG Clear/air fill/clear	4.8	0.51
		ALM-003-02 A	Aluminium A	DG Tint/air fill/clear	5.2	0.35
		ALM-003-03 A	Aluminium A	DG HSG low-e/air fill/clear	4.3	0.47
		ALM-003-04 A	Aluminium A	DG LSG low-e/air fill/clear	4.9	0.33
	Aluminium Group B double glazing air fill	ALM-004-01 A	Aluminium B	DG Clear/air fill/clear	4.8	0.59
		ALM-004-02 A	Aluminium B	DG Tint/air fill/clear	5.2	0.39
		ALM-004-03 A	Aluminium B	DG HSG low-e/air fill/clear	4.3	0.53
		ALM-004-04 A	Aluminium B	DG LSG low-e/air fill/clear	4.9	0.33
	Aluminium Group A double glazing argon fill	ALM-005-01 A	Aluminium A	DG Clear/argon fill/clear	4.5	0.50
		ALM-005-02 A	Aluminium A	DG Tint/argon fill/clear	5.1	0.32
		ALM-005-03 A	Aluminium A	DG HSG low-e/argon fill/clear	4.1	0.47
		ALM-005-04 A	Aluminium A	DG LSG low-e/argon fill/clear	4.8	0.34
Aluminium Group B double glazing argon fill	ALM-006-01 A	Aluminium B	DG Clear/argon fill/clear	4.5	0.61	
	ALM-006-02 A	Aluminium B	DG Tint/argon fill/clear	5.1	0.36	
	ALM-006-03 A	Aluminium B	DG HSG low-e/argon fill/clear	4.1	0.52	
	ALM-006-04 A	Aluminium B	DG LSG low-e/argon fill/clear	4.8	0.34	
Aluminium thermally broken	Aluminium thermally broken Group A double glazing air fill	ATB-003-01 B	Aluminium TB A	DG Clear/air fill/clear	3.6	0.47
		ATB-003-02 B	Aluminium TB A	DG Tint/air fill/clear	3.6	0.23
		ATB-003-03 B	Aluminium TB A	DG HSG low-e/air fill/clear	3.1	0.39
		ATB-003-04 B	Aluminium TB A	DG LSG low-e/air fill/clear	3.1	0.27
	Aluminium thermally broken Group B double glazing air fill	ATB-004-01 B	Aluminium TB B	DG Clear/air fill/clear	3.6	0.54
		ATB-004-02 B	Aluminium TB B	DG Tint/air fill/clear	3.6	0.30
		ATB-004-03 B	Aluminium TB B	DG HSG low-e/air fill/clear	3.1	0.49
		ATB-004-04 B	Aluminium TB B	DG LSG low-e/air fill/clear	3.1	0.27
	Aluminium thermally broken Group A double glazing argon fill	ATB-005-01 B	Aluminium TB A	DG Clear/argon fill/clear	3.5	0.47
		ATB-005-02 B	Aluminium TB A	DG Tint/argon fill/clear	3.4	0.32
		ATB-005-03 B	Aluminium TB A	DG HSG low-e/argon fill/clear	2.9	0.44
		ATB-005-04 B	Aluminium TB A	DG LSG low-e/argon fill/clear	3.0	0.27
	Aluminium thermally broken Group B double glazing argon fill	ATB-006-01 B	Aluminium TB B	DG Clear/argon fill/clear	3.5	0.64
		ATB-006-02 B	Aluminium TB B	DG Tint/argon fill/clear	3.4	0.40
		ATB-006-03 B	Aluminium TB B	DG HSG low-e/argon fill/clear	2.9	0.51
		ATB-006-04 B	Aluminium TB B	DG LSG low e/argon fill/clear	3.0	0.26

8. WINDOWS AND DOORS

Type	Code	Frame and operating type (Group A or B)	Glazing descriptions	Uw	SHGCw		
Composite	Composite Group A single glazing	CMP-001-01 I	Composite A	Clear	5.9	0.57	
		CMP-001-02 I	Composite A	Tint	6.2	0.41	
		CMP-001-03 I	Composite A	HSG low-e	4.6	0.36	
		CMP-001-04 I	Composite A	LSG low-e	4.6	0.36	
	Composite Group B single glazing	CMP-002-01 I	Composite B	Clear	5.9	0.65	
		CMP-002-02 I	Composite B	Tint	6.2	0.45	
		CMP-002-03 I	Composite B	HSG low-e	3.7	0.61	
		CMP-002-04 I	Composite B	LSG low-e	4.6	0.46	
	Composite Group A double glazing air fill	CMP-003-01 I	Composite A	DG	Clear/air fill/clear	3.9	0.51
		CMP-003-02 I	Composite A	DG	Tint/air fill/clear	3.9	0.32
		CMP-003-03 I	Composite A	DG	HSG low-e/air fill/clear	3.4	0.47
		CMP-003-04 I	Composite A	DG	LSG low-e/air fill/clear	3.4	0.32
	Composite Group B double glazing air fill	CMP-004-01 I	Composite B	DG	Clear/air fill/clear	3.9	0.59
		CMP-004-02 I	Composite B	DG	Tint/air fill/clear	3.9	0.37
		CMP-004-03 I	Composite B	DG	HSG low-e/air fill/clear	3.4	0.53
		CMP-004-04 I	Composite B	DG	LSG low-e/air fill/clear	3.4	0.33
	Composite Group A double glazing argon fill	CMP-005-01 I	Composite A	DG	Clear/argon fill/clear	3.9	0.50
		CMP-005-02 I	Composite A	DG	Tint/argon fill/clear	3.9	0.33
		CMP-005-03 I	Composite A	DG	HSG low-e/argon fill/clear	3.2	0.46
		CMP-005-04 I	Composite A	DG	LSG low-e/argon fill/clear	2.2	0.32
Composite Group B double glazing argon fill	CMP-006-01 I	Composite B	DG	Clear/argon fill/clear	3.9	0.63	
	CMP-006-02 I	Composite B	DG	Tint/argon fill/clear	3.9	0.40	
	CMP-006-03 I	Composite B	DG	HSG low-e/argon fill/clear	3.2	0.49	
	CMP-006-04 I	Composite B	DG	LSG low-e/argon fill/clear	2.2	0.39	
Fibreglass	Fibreglass Group A single glazing	FIB-001-01 W	Fibreglass A	Clear	5.4	0.56	
		FIB-001-02 W	Fibreglass A	Tint	5.4	0.41	
		FIB-001-03 W	Fibreglass A	HSG low-e	4.3	0.42	
		FIB-001-04 W	Fibreglass A	LSG low-e	3.7	0.35	
	Fibreglass Group B single glazing	FIW-002-01 W	Fibreglass B	Clear	5.4	0.63	
		FIW-002-02 W	Fibreglass B	Tint	5.4	0.49	
		FIW-002-03 W	Fibreglass B	HSG low-e	4.3	0.50	
		FIW-002-04 W	Fibreglass B	LSG low-e	3.7	0.38	
	Fibreglass Group A double glazing air fill	FIB-003-01 W	Fibreglass A	DG	Clear/air fill/clear	3.0	0.48
		FIB-003-02 W	Fibreglass A	DG	Tint/air fill/clear	2.9	0.33
		FIB-003-03 W	Fibreglass A	DG	HSG low-e/air fill/clear	2.3	0.26
		FIB-003-04 W	Fibreglass A	DG	LSG low-e/air fill/clear	2.3	0.19
	Fibreglass Group B double glazing air fill	FIB-004-01 W	Fibreglass B	DG	Clear/air fill/Clear	3.0	0.56
		FIB-004-02 W	Fibreglass B	DG	Tint/air fill/Clear	2.9	0.42
		FIB-004-03 W	Fibreglass B	DG	HSG low-e/air fill/clear	2.3	0.32
		FIB-004-04 W	Fibreglass B	DG	LSG low-e/air fill/clear	2.3	0.25
	Fibreglass Group A double glazing argon fill	FIB-005-01 W	Fibreglass A	DG	Clear/argon fill/clear	2.6	0.50
		FIB-005-02 W	Fibreglass A	DG	Tint/argon fill/clear	2.5	0.25
		FIB-005-03 W	Fibreglass A	DG	HSG low-e/argon fill/clear	2.0	0.25
		FIB-005-04 W	Fibreglass A	DG	LSG low-e/argon fill/clear	2.0	0.18
Fibreglass Group B double glazing argon fill	FIW-006-01 W	Fibreglass B	DG	Clear/argon fill/clear	2.6	0.53	
	FIW-006-02 W	Fibreglass B	DG	Tint/argon fill/clear	2.5	0.28	
	FIW-006-03 W	Fibreglass B	DG	HSG low-e/argon fill/clear	2.0	0.31	
	FIB-004-04 W	Fibreglass B	DG	LSG low-e/argon fill/clear	2.0	0.23	



8. WINDOWS AND DOORS

Type	Code	Frame and operating type (Group A or B)	Glazing descriptions	Uw	SHGCw		
uPVC	uPVC Group A single glazing	PVC-001-01 W	uPVC A		Clear	5.4	0.56
		PVC-001-02 W	uPVC A		Tint	5.4	0.41
		PVC-001-03 W	uPVC A		HSG low-e	4.3	0.42
		PVC-001-04 W	uPVC A		LSG low-e	3.7	0.35
	uPVC Group B single glazing	PVC-002-01 W	uPVC B		Clear	5.4	0.63
		PVC-002-02 W	uPVC B		Tint	5.4	0.49
		PVC-002-03 W	uPVC B		HSG low-e	4.3	0.50
		PVC-002-04 W	uPVC B		LSG low-e	3.7	0.38
	uPVC Group A double glazing air fill	PVC-003-01 W	uPVC A	DG	Clear/air fill/clear	3.0	0.48
		PVC-003-02 W	uPVC A	DG	Tint/air fill/clear	2.9	0.33
		PVC-003-03 W	uPVC A	DG	HSG low-e/air fill/clear	2.3	0.26
		PVC-003-04 W	uPVC A	DG	LSG low-e/air fill/clear	2.3	0.19
	uPVC Group B double glazing air fill	PVC-004-01 W	uPVC B	DG	Clear/air fill/clear	3.0	0.56
		PVC-004-02 W	uPVC B	DG	Tint/air fill/clear	2.9	0.42
		PVC-004-03 W	uPVC B	DG	HSG low-e/air fill/clear	2.3	0.32
		PVC-004-04 W	uPVC B	DG	LSG low-e/air fill/clear	2.3	0.25
	uPVC Group A double glazing argon fill	PVC-005-01 W	uPVC A	DG	Clear/argon fill/clear	2.6	0.50
		PVC-005-02 W	uPVC A	DG	Tint/argon fill/clear	2.5	0.25
		PVC-005-03 W	uPVC A	DG	HSG low-e/argon fill/clear	2.0	0.25
		PVC-005-04 W	uPVC A	DG	LSG low-e/argon fill/clear	2.0	0.18
uPVC Group B double glazing argon fill	PVC-006-01 W	uPVC B	DG	Clear/argon fill/clear	2.6	0.53	
	PVC-006-02 W	uPVC B	DG	Tint/argon fill/clear	2.5	0.28	
	PVC-006-03 W	uPVC B	DG	HSG low-e/argon fill/clear	2.0	0.31	
	PVC-006-04 W	uPVC B	DG	LSG low-e/argon fill/clear	2.0	0.23	
Timber	Timber Group A single glazing	TIM-001-01 W	Timber A		Clear	5.4	0.56
		TIM-001-02 W	Timber A		Tint	5.4	0.41
		TIM-001-03 W	Timber A		HSG low-e	4.3	0.42
		TIM-001-04 W	Timber A		LSG low-e	3.7	0.35
	Timber Group B single glazing	TIM-002-01 W	Timber B		Clear	5.4	0.63
		TIM-002-02 W	Timber B		Tint	5.4	0.49
		TIM-002-03 W	Timber B		HSG low-e	4.3	0.50
		TIM-002-04 W	Timber B		LSG low-e	3.7	0.38
	Timber Group A double glazing air fill	TIM-003-01 W	Timber A	DG	Clear/air fill/clear	3.0	0.48
		TIM-003-02 W	Timber A	DG	Tint/air fill/clear	2.9	0.33
		TIM-003-03 W	Timber A	DG	HSG low-e/air fill/clear	2.3	0.26
		TIM-003-04 W	Timber A	DG	LSG low-e/air fill/clear	2.3	0.19
	Timber Group B double glazing air fill	TIM-004-01 W	Timber B	DG	Clear/air fill/clear	3.0	0.56
		TIM-004-02 W	Timber B	DG	Tint/air fill/clear	2.9	0.42
		TIM-004-03 W	Timber B	DG	HSG low-e/air fill/clear	2.3	0.32
		TIM-004-04 W	Timber B	DG	LSG low-e/air fill/clear	2.3	0.25
	Timber Group A double glazing argon fill	TIM-005-01 W	Timber A	DG	Clear/argon fill/clear	2.6	0.50
		TIM-005-02 W	Timber A	DG	Tint/argon fill/clear	2.5	0.25
		TIM-005-03 W	Timber A	DG	HSG low-e/argon fill/clear	2.0	0.25
		TIM-005-04 W	Timber A	DG	LSG low-e/argon fill/clear	2.0	0.18
Timber Group B double glazing argon fill	TIM-006-01 W	Timber B	DG	Clear/argon fill/clear	2.6	0.53	
	TIM-006-02 W	Timber B	DG	Tint/argon fill/clear	2.5	0.28	
	TIM-006-03 W	Timber B	DG	HSG low-e/argon fill/clear	2.0	0.31	
	TIM-006-04 W	Timber B	DG	LSG low-e/argon fill/clear	2.0	0.23	

DG = double glazed; HSG = high solar gain; low-e = low-emissivity; LSG = low solar gain; SHGCw = solar heat gain coefficient for total window system; Uw = U-value for total window system

Refer to [Section 8.3.1 Default window libraries](#) for a description of the window codes.





IN THIS CHAPTER

9.1	Roof types	96
9.2	Ceiling types	97
9.3	Roof ventilation	99
9.4	Roof shape and volume	100
9.5	Insulation	102
9.6	Roof colour	103
9.7	Ceiling colour	104
9.8	Ceiling penetrations	104
9.9	Ceiling fans	108
9.10	Glazing	108
9.11	Australian Standards guide to recessed luminaire classification	110

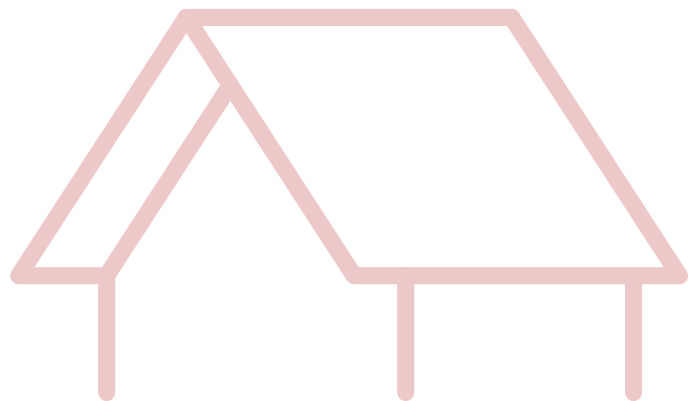



This chapter looks at common roof and ceiling types found in dwellings, gives an overview of the types of roof and ceiling insulation, and details the impact of ceiling penetrations. It also includes information about ceiling elements, roof coverings and treatment of roof/attic spaces.

Summary of key requirements

This handbook is intended to be a helpful resource for all assessors. When conducting assessments, assessors must follow the requirements of the current NatHERS Technical Note and the relevant state or territory requirements.

- 9a** Assessors must ensure that roof volumes are modelled according to the documentation; consult relevant software tool manual as necessary.
- 9b** If recommending changes to insulation, all documentation must be updated to reflect the changes before a NatHERS Certificate is produced.
- 9c** Roof colour or roof solar absorptance must be modelled as detailed in the documentation. Where this is not detailed, assessors must select the default roof colour as 'medium' (solar absorptance = 0.5).
- 9d** Ceiling colour – where there is an option to nominate a ceiling colour in the software and the colour has not been specified, assessors must model the default ceiling colour as 'medium'.
- 9e** If no electrical schedule or ceiling plan is available and the assessment is completed, it must clearly state on the NatHERS Certificate the dwelling has been modelled without recessed light fittings.
- 9f** All recessed light fittings, vents and exhaust fans must be modelled as ceiling penetrations.
- 9g** Unless otherwise stated by the manufacturer, assessors must include a minimum 50mm insulation clearance around ceiling penetrations.
- 9h** When recessed light fittings are specified in the documentation as insulated (or capable of being covered by insulation), model as 'insulated' or with no insulation clearance.
- 9i** Unless specified in the documentation or by the fitting manufacturer, all vents and exhaust fans must be treated as unsealed.
- 9j** Permanent static ventilation openings in the building fabric (e.g. flued gas heaters) are to be modelled as a wall or ceiling vent.
- 9k** Where a gas cooker is specified, model a 'sealed' exhaust fan.
- 9l** Where ceiling penetration information is incomplete, assessors must model default values as specified in **Tech Note Table 5**.
- 9m** Ceiling fans must only be modelled if they are included in the documentation. If the ceiling fan size is unknown, model fans as 900mm diameter.

9. CEILINGS AND ROOFS

9n If the dwelling is a steel framed construction, thermal bridging must be modelled ([Chapter 11](#)). (**Tech Note clause 11**)

9.1 Roof types

Many different types of roof construction are used in dwellings in Australia.

It can be helpful to understand the advantages and disadvantages that construction methods may have in different climates and locations, and for construction practices. More information about different construction systems is available on the Your Home website: www.yourhome.gov.au/materials/construction-systems.

In NatHERS software tools, roofs are referred to by how open they are. Roofs can be solid or have attic spaces between the roof and ceiling. NatHERS software tools also have different types of roofs/ceilings available: some have the option to model roofs and ceilings using different elements, while others have a static list of options. Assessors must refer to the relevant software tool manual for more information about modelling roof/ceiling constructions.

9.1.1 Roof/attic space

The typical roof/ceiling construction has a separate roof space or attic space and may use roof trusses. The ceiling lining is generally horizontal (i.e. flat) or can be sloped/raked at a different angle to the roof pitch (but still creating a separate roof space). The roof/attic space needs the degree of ventilation to be nominated (see [Section 9.3](#)).

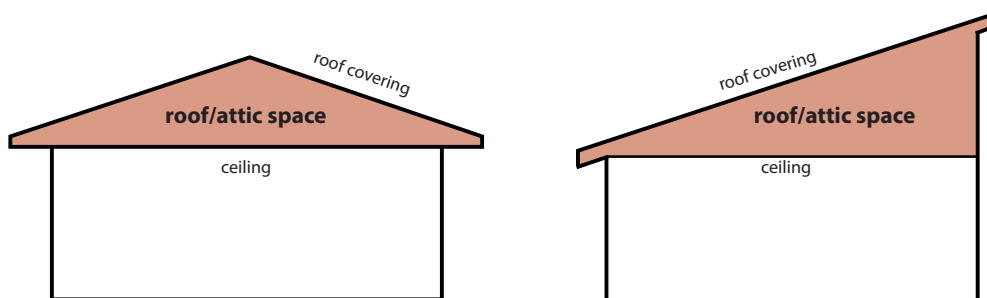

9.1.2 Raked/cathedral roof

Raked roofs/ceilings, also known as cathedral ceilings, typically have the ceiling lining parallel to the roof covering; there is no separate roof space. The roof/ceiling construction may be an insulated composite roof product (e.g. a solid product that includes ceiling lining, insulation and roof covering).

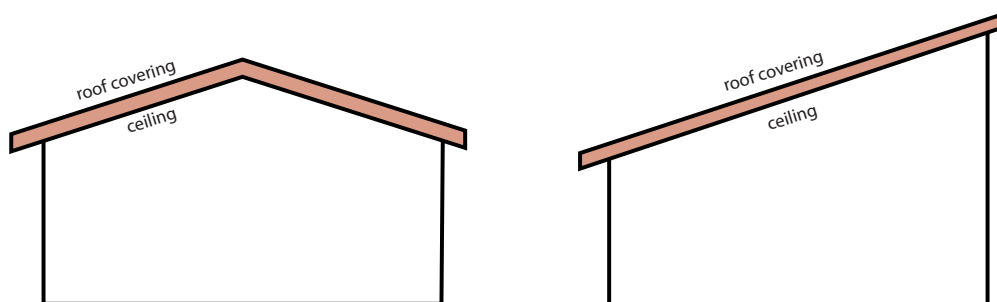

9.2 Ceiling types

Ceilings are defined as the lower part of a roof, the lower part of the attic space, or the underside of the floor in a multi-level construction.

9.2.1 Multi-level dwellings

NatHERS software tools have two types of ceiling construction for multi-level dwellings.

Ceiling to multi-level dwelling

In multi-level dwellings, because the ceiling to the underside of the floor between levels does not have an attic space above, it is to be modelled differently to the ceiling of the upper floor. This is because when the assessor selects what is above each ceiling (e.g. either another floor or an attic/roof space) the software calculates different assumptions for these spaces, such as predicted heat transfer and air movement of ventilation and infiltration.

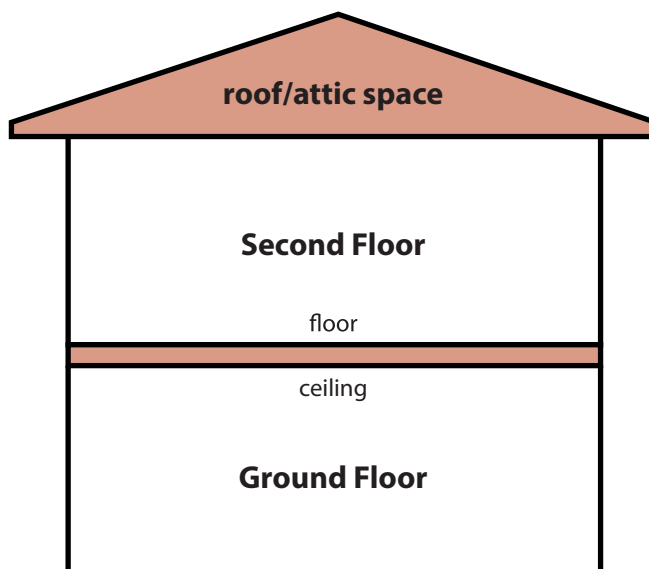

Ceiling to neighbour above

In Class 2 dwellings, the ceiling to the underside of the floor between the modelled dwelling and the dwelling above is modelled as 'neighbour' (or 'another apartment', depending on the software tool). The exception to this approach is the top or uppermost Class 2 dwelling in a building that would be appropriately treated as noted in [Section 9.1](#). In the diagram below, for example, apartments 1 and 2 would be modelled with ceilings to 'neighbour'. However, if apartment 3 is the top Class 2 apartment of the building, it would be modelled with a ceiling to attic/roof space.

Refer to the relevant software tool manual for more information on modelling ceilings.

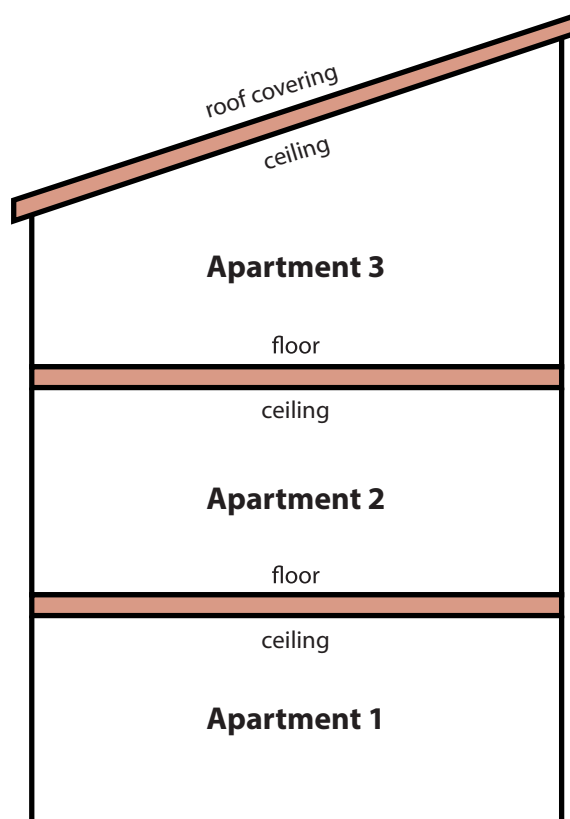

9. CEILINGS AND ROOFS

9.2.2 Raked/cathedral (sloping) ceiling

In NatHERS software tools, when a raked or sloping ceiling is modelled, the ceiling area is greater than the floor area and must be increased to model it correctly. Depending on the software tool, the ceiling area may be calculated automatically once the slope of the ceiling is entered by the assessor. In some software tools this calculation needs to be done manually.

For a manual calculation, the plan area is multiplied by a factor for the relevant roof pitch (see [Table 9-1](#) for area factors for typical roof pitches):

$$\text{ceiling area} = \text{plan area} \times \text{area factor.}$$

For example, for a 3m × 3m room with a 20 degree pitch ceiling, the ceiling area is 9.576m²:

$$(3 \times 3) \times \text{area factor} = 9 \times 1.064 = 9.576.$$

Table 9-1: Area of sloping ceilings

Slope/pitch (degrees)	Area factor
05.0	1.004
10.0	1.015
15.0	1.035
17.5	1.049
20.0	1.064
22.5	1.082
25.0	1.103
30.0	1.155
35.0	1.221
40.0	1.305
45.0	1.414

For roof pitches not listed in [Table 9-1](#), the ceiling area can be calculated by using the formula:

$$\text{ceiling area} = \text{plan area} / \cos(\text{ceiling pitch}).$$

For example, for a 3m × 3m room with a 12 degree pitch ceiling, the ceiling area is 9.20m²:

$$\cos(12^\circ) = 0.9781476, \text{ so } (3 \times 3) / 0.9781476 = 9.20.$$



9.3 Roof ventilation

The level of ventilation or openness to the roof space or attic significantly affects the thermal performance of a dwelling. The Chenath engine applies ventilation and air leakage assumptions in terms of air change rates, depending on the combination of roof material, ventilation options and if sarking is used as a continuous vapour barrier membrane.

NatHERS software tools treat roof ventilation in different ways, so the relevant software tool manual should be referenced for more information on roof ventilation.

Four ventilation types for a roof space or attic are used:

- **Discontinuous** – roof material covering a roof/attic space that allows ventilation through gaps in the covering (e.g. roof tile construction without sarking). Tiled roof construction for example, allows significant ventilation of the attic space through the gaps between the tiles.
- **Continuous** – a continuous roof material covering a roof (e.g. metal deck roofing or roof tile construction with sarking under the tiles). These roofs limit ventilation to the attic space and therefore have a lower air changes per hour assumption in the software.
- **Ventilated** – a roof/attic space with ventilators and eave vents. The attic spaces of these roofs are assumed more ventilated than the discontinuous type.
- **Highly Ventilated or Parasol** – a roof/attic space that is very well ventilated and considered not to be enclosed. For example, a roof that is completely shaded by a parasol like shade that still allows the roof to be exposed to outdoor air. These attic spaces have the highest air changes per hour assumption.

The following roof/ceiling types may be listed in NatHERS software tools but do not have a roof space or attic:

- **Flat framed** – flat roof or timber construction, also used for raked/cathedral (sloping) ceilings and skillion roofs.
- **Slab** – suspended slab, flat roof of concrete construction.
- **SlabExt** – suspended slab, flat roof of concrete construction with external insulation.
- **Unvented, no cavity** – roof and ceiling construction with a still air gap.
- **Neighbour/another apartment** – ceilings adjacent to other dwellings that are not part of the dwelling being modelled.



9.4 Roof shape and volume

It is important to ensure that the volume of the roof/attic space is calculated and modelled correctly as it can have a significant effect on the dwelling's thermal performance.

The shape of a roof/attic space determines the volume of the roof/attic space of the dwelling.

9.4.1 Roof shape

Four typical roof shapes are used in NatHERS software tools.

Table 9-2: Typical roof shapes are used in NatHERS software tools

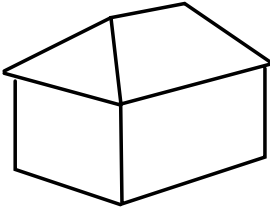
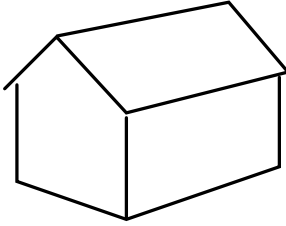
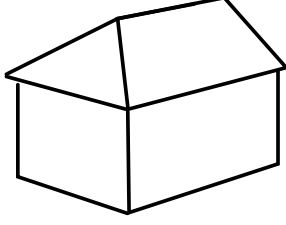
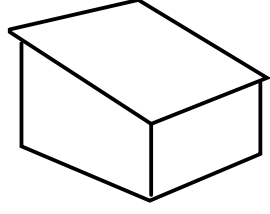
Hip roof	All sections of the roof slope downwards to the walls. Hip roofs model minimal roof space volume. Refer to the relevant software tool manual for details on how to model a hip roof.	
Gable roof	Two roof sections slope in opposite directions with the highest horizontal edges forming the roof ridge; vertical roof sections are at each end. Refer to the relevant software tool manual for details on how to model a gable roof and gable end walls.	
Hip/gable roof	A combination of the above two types, where one roof end is vertical and one is sloped. Refer to the relevant software tool manual for details on how to model a hip/gable roof.	
Skillion (raked/cathedral) roof	Unlike a hip or gable roof, where each has at least two sloping sides, a skillion roof is mono-pitched, with only one slope and no centre ridge. Refer to the relevant software tool manual for details on how to model a skillion roof.	

Calculating complex roof shapes and volumes (such as those with multiple valleys and half hips) may require additional measuring from the assessor, as well as an understanding of basic formula calculations. Assessors must refer to their software tool manual for advanced roof modelling guidance.

9. CEILINGS AND ROOFS

9.4.2 Roof volume

9a Assessors must ensure that roof volumes are modelled according to the documentation; consult relevant software tool manual as necessary.

Depending on the NatHERS software tool being used, the roof space volume may need to be entered, or may be calculated automatically.

Depending on the NatHERS software tool being used, the roof space volume may need to be entered, or may be calculated automatically.

The roof space volume is generally calculated within the external walls – it does not typically include the eave overhangs but does include the roof of the dwelling where it extends over covered outdoor areas (also known as alfrescos, patios, porticos or verandahs) when these areas have a ceiling.

Whether the volume is calculated from within the external walls depends on the roof construction; this dictates whether the eave overhangs should be modelled. In most conventional housing, the volume of the main roof space will be closed off from the eave roof space so the eave overhangs should not be modelled. In some constructions however, the roof volume within the eaves is open to the main roof volume and should be modelled (such as in tropical climates when ventilated eaves are used).

9.4.3 Combinations within a zone

A dwelling sometimes has different roof/ceiling construction types within a zone. It is important to model these vertical walls or bulkheads because they result in a larger ceiling surface area.

The method and adjustments required to correctly model these properties differ depending on the software tool. Refer to the relevant software tool manual for more information on modelling wall to roof spaces or splitting zones to allow for different roof/ceiling properties. Also refer to the National Construction Code (NCC) Building Fabric Thermal Insulation requirements.

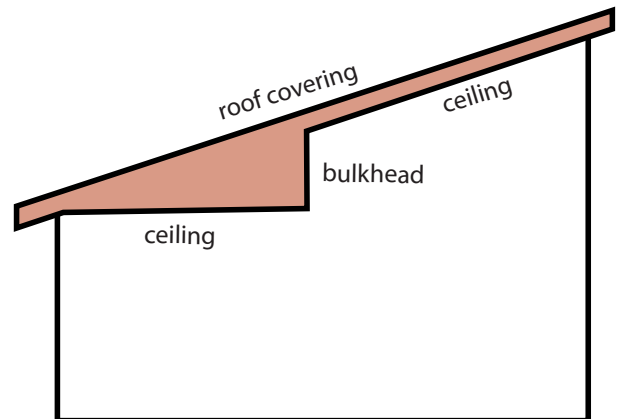

9.5 Insulation

The key concepts of insulation have been covered in [Section 7.3](#). The application of insulation for roofs and ceilings is detailed below.

9.5.1 Insulation types

Three main types of insulation are used in roof/ceiling construction:

- **Bulk insulation** reduces heat flow by creating small pockets of trapped air that are poor conductors of heat. Bulk insulation is commonly used on ceilings and between floors in multi-level and Class 2 dwellings. The main types of bulk insulation used in Australia are:
 - batts and blankets (e.g. glasswool, rockwool, natural wool, jute, polyester)
 - loose fill insulation (e.g. cellulose fibre, natural wool, granulated rockwool)
 - boards (e.g. extruded and expanded polystyrene insulating boards).

Some building materials may act as a construction system and provide insulation as well.

- **Reflective insulation (foils)** consists of a thin layer of aluminium foil bonded onto one or both sides of a paper base. As noted in [Section 7.3](#), reflective foil insulation must be associated with an air gap to improve thermal performance.

Sarking may also be defined as a foil if it has reflective/emissivity properties, and in this case should be treated as such in NatHERS software tools (i.e. modelled with an appropriate air gap). However, modern sarking may be vapour-permeable if it does not include a thin layer of foil. In this case it has different properties to those included in NatHERS software tools.

The type of sarking used under a roof will vary according to the climate and location of the dwelling. Manufacturer's specifications should be consulted to ensure that the correct emissivity values are modelled for air gaps.

The main types of reflective insulation used in Australia are:

- rolls (e.g. single- or double-sided rolls used for sarking)
 - multi-cell insulation, consisting of two, three or four layers of laminated foil separated by partitioning
 - expandable insulation (e.g. double-sided reflective foil laminate formed into an expandable concertina)
 - bonded to bulk (e.g. reflective foil bonded to insulating blankets or polystyrene board).
- **Composite insulation** comprises one or more materials combined to make a single insulation product. The main types of composite insulation used in Australia are:
 - single-sided, foil-faced blanket (e.g. reflective foil bonded to a single side of glasswool insulation)
 - double-sided, foil-faced blanket (e.g. reflective foil bonded to both sides of glasswool insulation)
 - bonded to bulk (e.g. reflective foil bonded to expanded polystyrene board).

If recommending insulation changes, assessors should ensure that the product is suitable. As the NCC requires that bulk insulation must not be compressed, it is important that the insulation modelled as part of the assessment will fit into the designed space.

- 9b** If recommending changes to insulation, all documentation must be updated to reflect the changes before a NatHERS Certificate is produced. (**Tech Note clause 3.3**)

Details of insulation products, including thickness, R-value, k-value and emissivity of surfaces are generally available from the manufacturer's website. Further information about R- and k-values is available from the Insulation Council of Australia and New Zealand Insulation Handbook <https://icanz.org.au/wp-content/uploads/2023/03/FINAL-ICANZ-HANDBOOK-PART-2-V6-FINAL-13.12.2020.pdf>



9. CEILINGS AND ROOFS

9.5.2 Insulation to perimeter of a roof space

In colder climates in Australia, it is common to specify ceiling insulation of R4.1 or greater.

R4.1 glasswool insulation is 210mm thick in its uncompressed form. Insulation with higher R-values is thicker. Around the perimeter of a dwelling, this thick ceiling insulation may be in contact with the underside of the roof covering and/or sarking, acting as a path for moisture between the roof and ceiling into the dwelling.

Installation of bulk insulation requires that it not be compressed. Therefore, where the roof slopes down to meet the ceiling on the perimeter of the dwelling, a thinner bulk insulation might need to be installed (see the example installation in [Figure 9-1](#)). This ensures that the bulk insulation is not compressed and does not contact the underside of the roof, thereby reducing the likelihood of condensation.

Assessors must model any edge batts shown in the documentation. The **default** R3.0 and 450mm width must be applied if values are not obtainable. Refer to the relevant software tool manual for more information on modelling perimeter ceiling insulation, also often referred to as edge batt insulation.

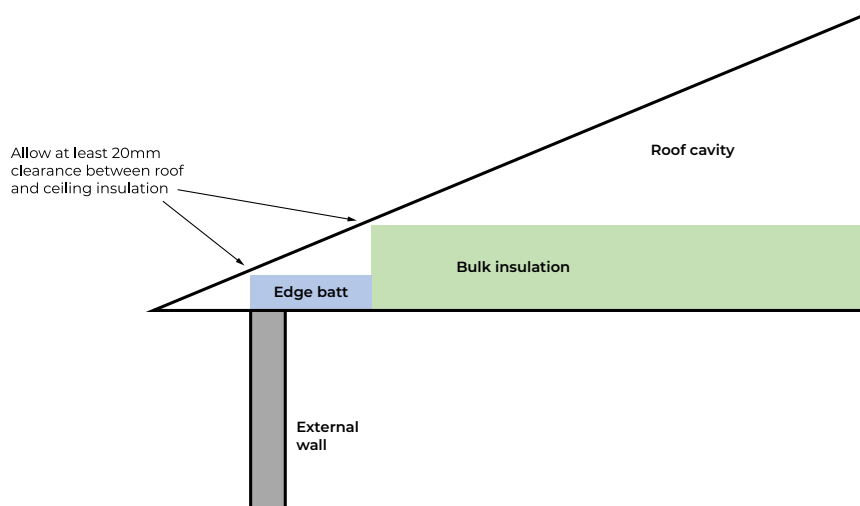

Figure 9-1: Example of perimeter insulation installation

If the documentation specifies a change to the bulk insulation in the ceiling at the perimeter of the roof space, assessors must model as detailed in the documentation. If the documentation does not indicate perimeter edge insulation, assessors must apply a default R3.0 and 450mm width if values are not attainable.

9.6 Roof colour

The roof colour affects how the building reflects or absorbs heat and can be used to help heat or cool the dwelling.

In general, darker colours absorb heat and lighter colours reflect heat. However, depending on the dwelling location, size and whether the roof space is insulated, the roof colour may have only a minimal effect on the dwelling's rating, particularly in cooler climates. In some warmer climates, roof colour may have a greater effect on the rating. Multiple testing in NatHERS software tools may be required to ensure that the worst-case scenario for the location and climate of the dwelling has been applied.

9c Roof colour or roof solar absorptance must be modelled as detailed in the design documentation. Where this is not detailed, assessors must select the default roof colour as 'medium' (solar absorptance = 0.5). (**Tech Note clause 9.2**)



9.7 Ceiling colour

Some NatHERS software tools require the finished colour of ceilings to be modelled, while in others, this is built into the software and does not need to be entered by the assessor. If the software tool requires a ceiling colour to be entered and the documentation does not specify one, the ceiling colour must be entered as 'medium'.

9d Ceiling colour – where there is an option to nominate a ceiling colour in the software and the colour has not been specified, assessors must model the default ceiling colour as 'medium'. (**Tech Note clause 9.3**)

9.8 Ceiling penetrations

Assessors must model all recessed light fittings, vents and exhaust fans as ceiling penetrations. (**Tech Note clause 9.4**) Penetrations affect the thermal performance of a dwelling in two ways:

- loss of ceiling insulation, which may significantly reduce the average R-value of the ceiling insulation across a roof space
- increased, uncontrolled air infiltration between zones and the roof/attic space.

The NatHERS Technical Note clauses 9.4–9.8 outline these specific requirements on modelling and categorising ceiling penetrations.

Many jurisdictions require assessors to input information in accordance with a ceiling plan/electrical schedule but for some states and territories this level of detail may not be required for compliance purposes. Should this information be unavailable, and the assessment is completed, it must be clearly stated on the NatHERS Certificate the dwelling has been assessed without recessed light fittings. If these features are present in the dwelling, the assessment will need to be updated for compliance purposes.

9e If no electrical schedule or ceiling plan is available and the assessment is completed, it must clearly state on the NatHERS Certificate the dwelling has been modelled without recessed light fittings.

9f All recessed light fittings, vents and exhaust fans must be modelled as ceiling penetrations.

It is a NatHERS requirement that assessors input information about ceiling penetrations in accordance with the dwelling's lighting location plan/electrical schedule. However, if this information is unavailable because the jurisdiction does not require a lighting location plan/electrical schedule as part of the approvals process, it may be appropriate to use suitable assumptions. If this is the case and assumptions are used, they must be stated on the NatHERS Certificate. If the dwelling has lighting features installed that do not align with the NatHERS Certificate (e.g. downlights), the assessment will need to be updated for compliance purposes.

An updated assessment may then be required once electrical information is available to confirm the number of ceiling penetrations for the approvals process or for compliance of the completed dwelling. If the number of ceiling penetrations exceeds the number shown on the NatHERS Certificate, the certificate may become non-compliant, depending on jurisdictional requirements and the stage of compliance, as briefly mentioned above. This compliance is primarily the client's responsibility. However, assessors should be aware of this and may want to speak with their state or territory jurisdiction to confirm the relevant requirements.

If any of the ceiling penetration information is not specified or incomplete, assessors must apply the defaults in [Table 9-3](#). Existing parts of dwellings undergoing a major renovation will require informed assessor discretion as the shown defaults may be inappropriate.



9. CEILINGS AND ROOFS

Table 9-3: Default ceiling penetration modelling

Type	How to model defaults
No lighting specifications	<ul style="list-style-type: none">• Sealed• Zone area <5m²: model 1 downlight• Zone area 5-10m²: model 2 downlights• Zone area >10m²: model 1 downlight per 2.5m²• 50mm insulation clearance
Lights indicated, but no details	<ul style="list-style-type: none">• Sealed downlight• 50mm insulation clearance
Exhaust fan	<ul style="list-style-type: none">• Sealed in conditioned zones• Unsealed in unconditioned zones• 250mm diameter• 50mm insulation clearance
Kitchen rangehood	<ul style="list-style-type: none">• 250mm diameter sealed exhaust fan• 50mm insulation clearance
Fan light heater	<ul style="list-style-type: none">• Sealed in conditioned zones• Unsealed in unconditioned zones• 250mm exhaust fan• 50mm insulation clearance
Heating device flue	<ul style="list-style-type: none">• Add 100mm clearance if flue diameter is known• If flue diameter is not known allow a total of 300mm insulation clearance

9.8.1 Loss of insulation

Ceiling penetrations, such as recessed light fittings, are modelled in the software with a specified clearance to surrounding bulk insulation as a clearance area without insulation is generally required around the fitting for safety purposes. Depending on the assessor's software tool, this may be displayed as selecting 'insulated' or 'uninsulated' when modelling the penetration. If a clearance distance is required in the software tool, and the penetration is specified as being covered by insulation, it may be appropriate to enter a clearance of zero.

NatHERS software tools require all ceiling penetrations to be modelled, whether ceiling insulation is specified or not, including an intermediate floor between levels in a multi-level dwelling. NatHERS software tools model the ceiling area with the specified insulation and without insulation where penetrations occur.

If the documentation does not specify insulation clearances, assessors can check manufacturer product information for guidance. Manufacturer's data information and clearances must be referenced when the model numbers of the recessed fittings are known. If the provided documentation has limited electrical details for the recessed light fittings specified, the following provision must be followed as per the NatHERS Technical Note.

9g Unless otherwise stated by the manufacturer, assessors must include a minimum 50mm insulation clearance around ceiling penetrations. (**Tech Note Table 5**)

Exhaust fans

Where an exhaust fan is specified, assessors must model the size of the duct or flue shown on the documentation or manufacturer's specification. Should exhaust fan or fan/light information not be provided, assessors should model as per [Table 9-3](#).

The National Construction Code requires internal (i.e. without a window or door) bathrooms, WCs and ensuites to have mechanical ventilation. If an exhaust fan is not shown on the documentation, it would be best practice for assessors to check with the client and confirm whether an exhaust fan should be present and request updated documentation if necessary.



9. CEILINGS AND ROOFS

Recessed light fittings

For NatHERS purposes, recessed luminaires are described as recessed light fittings, although they are more commonly referred to as downlights, and must be modelled as shown in the documentation.

Generic electrical plans are sometimes used for the modelling, and the type and/or model number of the recessed fittings are often not specified. If any of the ceiling penetration information is not specified or incomplete, assessors must apply the defaults in Table 9-3. Existing parts of dwellings undergoing a major renovation will require informed assessor discretion as the defaults may be inappropriate. Recessed light fittings may be modelled in three ways (depending on what is specified on the documentation):

- with added side clearance
- without added side clearance (i.e. the insulation is abutted to the light fitting)
- without side clearance and covered over by the ceiling insulation.

Figure 9-2 provides guidance on minimum clearances for recessed light fittings (luminaires).

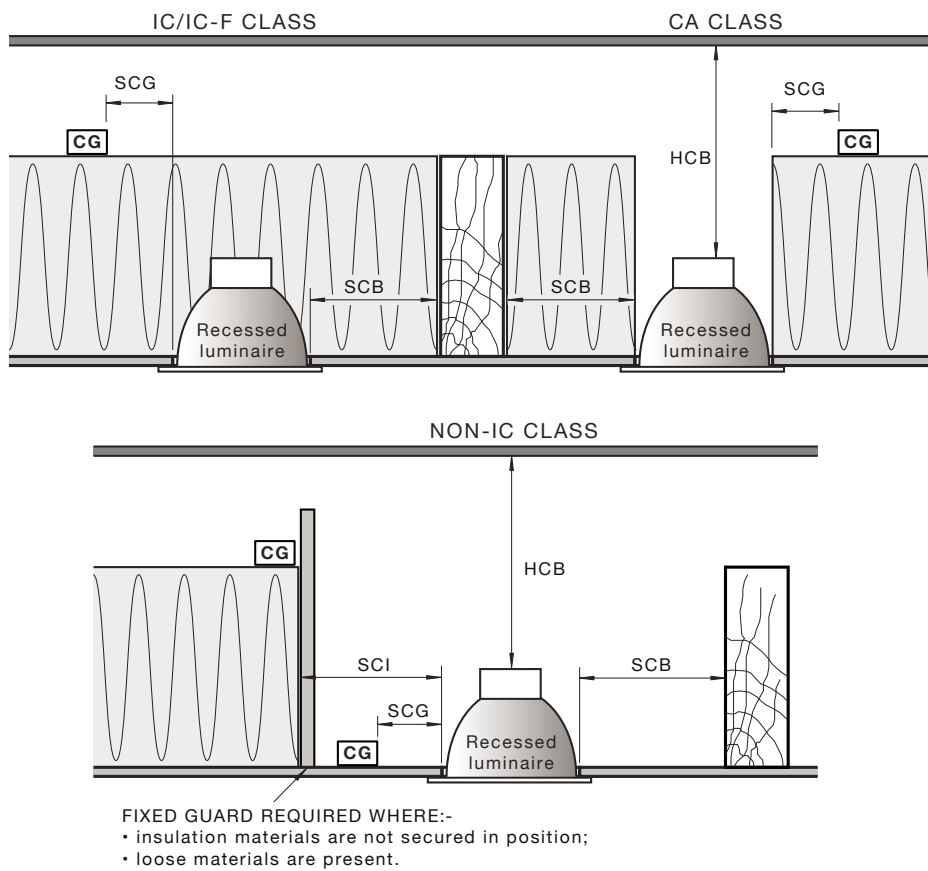

Dimension	Any lamp up to 100 W
HCB—height clearance to building element	100 mm
SCB—side clearance to building element	100 mm
SCI—side clearance to insulation	100 mm
SCG—side clearance to auxiliary equipment [control gear (CG)]	50 mm

Source: AS/NZS AS/NZS 3000:2018 Fig 4.9. © Standards Australia Limited. Copied by the Dept of Environment and Energy with the permission of Standards Australia and Standards New Zealand under Licence 1902-c025

Figure 9-2: Minimum clearances for recessed luminaires



9. CEILINGS AND ROOFS

With added side clearance – recessed light fittings generate heat and clearance is required between fittings and thermal insulation and roof framing members.

Without added side clearance – some types of recessed light fittings may be specified as capable of being abutted to insulation with no added side clearance required. If specified as such in the documentation, the light fitting may be modelled with a clearance value the same as the light fitting size.

Without added side clearance and covered – some types of recessed light fittings may be specified as capable of being covered by insulation and can be modelled as 'insulated' or with no added side clearance and covered by insulation. When these are specified the fitting will have no impact on loss of insulation.

9h When recessed light fittings are specified in the documentation as insulated (or capable of being covered by insulation) model as 'insulated' or with no insulation clearance.

In 2016, Standards Australia published the joint Australian/New Zealand Standard AS/NZS 60598.2.2-2016, *Luminaires—Part 2.2: Particular requirements—Recessed luminaires (IEC 60598-2-2, Ed. 3.0 (2011) MOD)*. Part of Appendix ZD1 is included in [Section 9.11](#) of this chapter. It gives guidance on the classifications, symbols, applications and general restrictions on recessed luminaires.

Refer to the relevant software tool manual for more information on modelling recessed light fittings.

9.8.2 Increased infiltration

In NatHERS software tools, the control of air infiltration is specified by sealing or not sealing a penetration. Ceiling penetrations are therefore modelled as 'sealed' or 'unsealed', which refers to the assumption of uncontrolled air infiltration or movement calculated in the Chenath engine. If unsealed, ceiling penetrations can create a ventilation path from the rooms to the roof/attic space, allowing hot or cool air from the room to escape into the roof/attic space. For example, if the exhaust fan has a damper specified, or the rangehood includes filters, the assumption of air movement through the penetration is less than if these are determined as unsealed and there are greater levels of assumed air movement.

Unsealed penetrations – if the documentation does not indicate that a ceiling mounted exhaust fan, ceiling vent or open fireplace chimney contains a damper or similar, it is treated as worst case; that is, 'unsealed'.

9i Unless specified in the documentation or by the fitting manufacturer, all vents and exhaust fans must be treated as unsealed. (**Tech Note clause 9.6**)

Refer to the relevant software tool manual for more information on unsealed penetrations.

Sealed penetrations – if the documentation indicates a ceiling-mounted exhaust fan, or open fireplace chimney contains a damper or similar, it can be treated as 'sealed' in NatHERS software tools.

Slow-combustion fireplaces are considered to be sealed but require loss of insulation around the flue to be modelled. If the documentation does not specify insulation clearances, assessors can check manufacturer product information for guidance.

9j Permanent static ventilation openings in the building fabric (e.g. flued gas heaters) are to be modelled as a wall or ceiling vent.

9k Where a gas cooker is specified, model a 'sealed' exhaust fan.

Where a gas cooker exhaust is specified on the documentation, assessors can model it as a 'sealed' exhaust fan. This aligns with the principle in the National Construction Code requirement that gas cookers must be ventilated to outside air.

Rangehoods or electric cookers with a flue can also be modelled as sealed/closed if specified as such on the documentation. Ductless rangehoods that recirculate the air back into the room and do not penetrate the ceiling are not required to be modelled as a penetration.

9l Where ceiling penetration information is incomplete, assessors must model default values as specified in . (**Tech Note clause 9.7**)



9. CEILINGS AND ROOFS

Although the Chenath engine does not currently distinguish a difference in air movement and infiltration between whether the ceiling penetration is to a ceiling with dwelling above or a ceiling with roof above, it must still be modelled for NatHERS purposes.

9.9 Ceiling fans

Ceiling fans provide a cooling benefit to a dwelling and reduce the cooling load component of the thermal performance. They are often more beneficial in warm to hot climates than in cool to cold climates in Australia.

In NatHERS software tools, ceiling fans are not assumed to affect air leakage or infiltration, rather they affect air movement and are assumed not to penetrate the ceiling insulation. The larger the fan, the greater the air speed the fan produces and therefore the greater the area in the zone affected by the ceiling fan. The Chenath engine averages the summer comfort benefit over the total area of the room. Therefore in larger rooms using ceiling fans with a greater diameter and/or multiple fans will be more effective. Zone temperatures within the software tool simulations do not include air movement effects. When the zone temperature is above the cooling thermostat setting, the Chenath engine will not activate cooling if turning on ceiling fans or opening windows will create a comfortable zone temperature.

One limitation of the Chenath engine is that of the impact of air speed on comfort is not shown within the calculations. Although the Chenath engine calculates the impact of air movement from ceiling fans and cross-ventilation on comfort when calculating energy use, it does not calculate the comfort temperatures affected by air speed. Therefore there may be times when a zone appears to be uncomfortable but this is potentially incorrect because of the reduction in perceived temperature due to air movement of the ceiling fan.

Ceiling fans can be added to each zone. The diameter of each fan needs to be entered into the software tool.

The diameters available range from 900mm to 3000mm. These determine the air speed generated in the vicinity of the fan and hence the cooling benefit.

9m Ceiling fans must only be modelled if they are included on the documentation. If the ceiling fan size is unknown, model fans as 900mm diameter.

Refer to the relevant software tool manual for more information about modelling ceiling fans.

9n If the dwelling is steel framed construction, thermal bridging must be modelled ([Chapter 11](#)) (**Tech Note clause 11**).

Thermal bridging modelling is only undertaken for dwellings with steel framed construction. Refer to [Chapter 11](#) for background information and modelling guidance.

9.10 Glazing

Glazed or Perspex elements such as skylights and roof windows introduce natural light and can improve ventilation within a zone. However, the inclusion of a glazed roof element may improve or be detrimental to the thermal performance of a dwelling, depending on the location and orientation of the element.

Assessors must refer to the relevant software tool manual for more information about modelling skylights and roof windows. Clerestory windows also introduce natural light and can improve ventilation and are covered in [Chapters 7](#) and [8](#) of this Handbook. [Chapter 8](#) also covers more detailed information on skylights and roof windows.

The definitions of skylights and roof windows outlined in [Section 9.10.1](#) and [9.10.2](#) are specific to NatHERS software modelling. This may differ from the broader definition of these products available on the market and their corresponding characteristics. Assessors must not rely on the product title and must understand the characteristics of the product specified to confirm the correct feature is used within the NatHERS software.



9. CEILINGS AND ROOFS

9.10.1 Skylight

For the purposes of modelling in NatHERS, a skylight is a fixed glazed or Perspex element, penetrating the roof construction and connected to a zone by a built-in shaft that passes through a roof/attic space.

Inclusion of a skylight can reduce the area of roof and ceiling with insulation, increasing the heat flow and air movement to the zone. The example skylight shown below is a tubular/dome skylight, however skylights can also be rectangular.

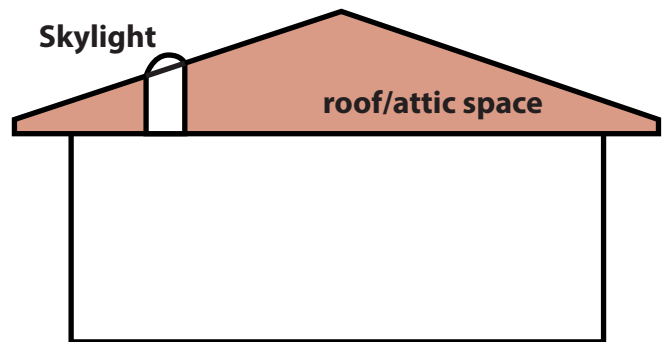

Figure 9-3: Skylight

9.10.2 Roof window

For the purposes of modelling in NatHERS, a roof window is a glazed element in a roof that does not have a roof/attic space; it can be either fixed or openable and penetrates the roof construction.

Roof windows can also be quite complex, for example if a window is surrounded by a thicker ceiling/roof construction that may look like a skylight shaft. It is recommended assessors seek modelling advice from their software provider or relevant Assessor Accrediting Organisation.

The area of roof/ceiling with insulation is reduced where a roof window is located, increasing the heat flow and air movement to the zone. It is also important to note that depending on the software tool, it may not be possible to model roof windows.

Refer to [Chapter 8](#) and the relevant software tool manual for more information on how to model the properties of skylights and roof windows.

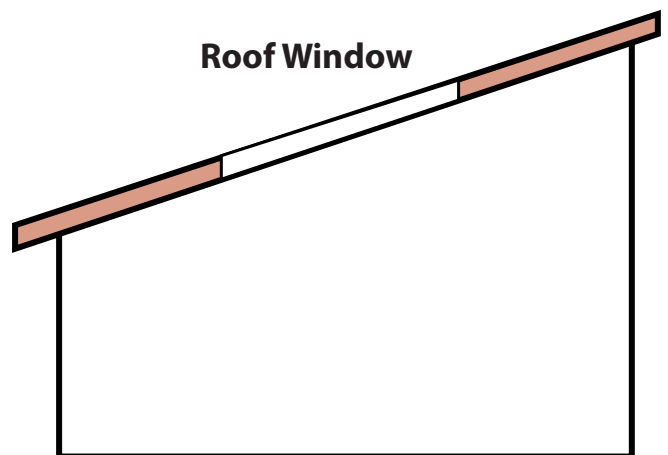
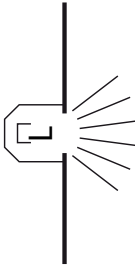
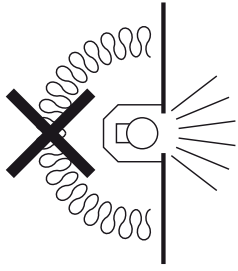
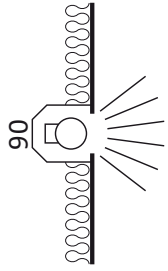

Figure 9-4: Roof window



9.11 Australian Standards guide to recessed luminaire classification

(excerpt from AS/NZS 60598.2.2-2016)

Type	Symbol	Abutted*	Normal use† covered	Use with insulation ‡	Accessibility to high temperature parts §	Surface of luminaire normal operating temperature limit	Comments
Non-IC		No	No	No	Fully accessible	No limit on side or top surface of luminaire Mounting surface of luminaire limited to 90°C	Suitable for use in Australia and New Zealand – intended for commercial industrial use only. Not for residential use. Not for use in residential dwellings or other places where building insulation may be installed (now or in the future). These luminaires have not been tested for use with building insulation.
Do Not Cover		No	No	No	Fully accessible	No limit on side of top surface of luminaire Mounting surface of luminaire limited to 90°C	Suitable for residential or commercial use in Australia. Cannot be covered. Manufacturer's stated clearance distances from sides of luminaire to insulation, and clearance above luminaire, will be in the installation instructions supplied with the luminaire, indicating clearances have to be observed at all times for correct installation. These luminaires have been tested to show that they are for use with building insulation present, observing manufacturer's stated installation clearance distances. They cannot be covered with building insulation. However, they have been tested to show that if inadvertently covered they should not become a fire hazard.
CA90		Yes	No	Yes	Limited access In this Standard, this is assessed for access to high temperature parts by use of a 5.6mm probe to side and top of luminaire	90°C limit on side or top or mounting surface of luminaire	Suitable for residential or commercial use in Australia and New Zealand. Cannot be covered. Insulation can be placed against the sides of the luminaire. Manufacturer's stated clearance above the luminaire will be in the instructions provided with the luminaire, indicating clearance has to be observed for correct installation. These luminaires have been tested to show that they are for use with building insulation present and placed against the sides of the luminaire. They cannot be covered in building insulation. However, they have been tested to show that if inadvertently covered they should not become a fire hazard.

9. CEILINGS AND ROOFS

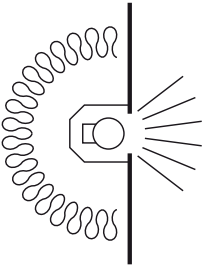
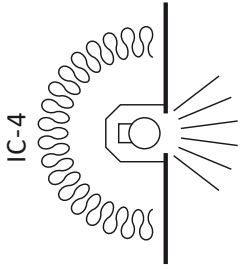
Type	Symbol	Abutted*	Normal use† covered	Use with insulation ‡	Accessibility to high temperature parts §	Surface of luminaire normal operating temperature limit	Comments
IC		Yes	Yes	Yes	Limited access In this Standard, this is assessed for access to high temperature parts by use of a 5.6mm probe to sides and top of luminaire	90°C limit on side or top or mounting surface of luminaire	Suitable for residential or commercial use in Australia and New Zealand. Used where some air transfer is allowed or desired between living space and roof space (there will be some air transfer between the spaces, if the luminaire is not fully covered in insulation). These luminaires have been tested to show they are suitable for normal use when covered in building insulation.
IC-4		Yes	Yes	Yes	Restricted access In this Standard, this is assessed for access to high temperature parts by use of a IP4X—1mm probe to sides, top and front face of luminaire	90°C limit on side or top or mounting surface of luminaire	Suitable for residential or commercial use in Australia and New Zealand. Used where air transfer is not permitted or not desired between living space and roof space (there will be no air transfer between spaces even if there is no insulation covering the luminaire). Typical use is passive house design where no air transfer is allowed. These luminaires have been tested to show that they are suitable for normal use when covered in building insulation.
No Marking		No	No	No	No		Not verified as tested/compliant to Australian/New Zealand standards. Marking is required by standards – no marking indicates non-compliance. Installation instructions specifying any clearance distance is required by this Standard. Do not install any luminaire that does not have one of the marking symbols or instructions specifying any clearance distances. NOTE: For luminaires installed prior to the publication of this Standard (AS/NZS 60598.2.2:2016), which do not have marking and/or installation instructions with clearance distances specified, refer to AS/NZS 3000.

* May be abutted against normally flammable building elements or insulation.

† Intended and tested for use under building insulation as part of normal operation.

‡ May be used where building insulation may be installed (now or in the future).

§ Classification and probe to determine access of insulation etc. to high temperature parts.

Source: AS/NZS 60598.2.2-2016 Appendix Fig ZD1. © Standards Australia Limited. Copied by the Dept of Environment and Energy with the permission of Standards Australia and Standards New Zealand under Licence 1902-c025





IN THIS CHAPTER

10.1	Applying shading	114
10.2	Horizontal shading	114
10.3	Vertical shading	118
10.4	Neighbouring buildings	124
10.5	Vegetation	126





Shading can make the difference between a dwelling being comfortable or uncomfortable.

The shade cast onto a dwelling can limit the amount of solar radiation striking the external surface and then being transferred inside the dwelling. Large shadows can be beneficial in summer and in warmer climates. Conversely, small shadows and higher solar gain can be beneficial in winter and in colder climates.

There are different types of shading devices, including those built onto a dwelling (such as eaves or pergolas) or those separate to the dwelling, including screens or neighbouring buildings. Shading is an area where NatHERS software tools vary considerably so it is important to refer to the relevant software tool manual for guidance.

Summary of key requirements

This handbook is intended to be a helpful resource for all assessors. When conducting assessments, assessors must follow the requirements of the current Technical Note and the relevant state or territory requirements.

- 10a** Assessors must model all fixed and non-fixed shading features shown in the documentation. Where there is a limit to the number of shading devices that can be modelled in the software tool, model the three that have the largest impact on the rating.
- 10b** Assessors must model the width of an eave or horizontal shading device from the face of the external wall to the bottom of the fascia board or the underside of the outer edge of the horizontal shading device. Gutters may be modelled at the assessor's discretion.
- 10c** If the fascia board casts a greater shadow than the gutter, assessors must model shading from the bottom of the fascia.
- 10d** Assessors must model neighbouring buildings and surrounding topographical features which obstruct the sun, including considering the impact of level changes and retaining walls.
- 10e** Assessors must model all neighbouring shade features north of the Tropic of Capricorn. Shade features south of the Tropic of Capricorn between the midpoints SSE and S, and S and SSW (i.e. within the range of 168°45' to 191°15') need not be modelled but may be included for greater accuracy.
- 10f** Where information on neighbouring buildings is not shown on the documentation, assessors must request the documentation be updated or obtain supporting evidence of existing neighbouring buildings for the purpose of modelling, e.g. Google maps.
- 10g** Where neighbouring buildings are unknown because the dwelling is located in a new development site, NatHERS Technical Note provisions must be applied.

- 10h** Balconies or similar spaces with solid, glazed or partially glazed walls to either side of the parent wall are to be modelled as wing walls. Balcony walls with solid building elements directly in front of the parent wall are to be modelled as an external screen with 100% shading for the portion of the wall that is solid and 10% shading for the portion of the wall that is glazed.
- 10i** Only trees with an existing preservation order or heritage protection must be modelled. No other vegetation may be modelled as shade. The design documentation must include:
- the tree canopy drawn to scale or dimensioned
 - existing preservation order or heritage listing.

10.1 Applying shading

In NatHERS software tools, shading can be applied to walls and/or windows. When discussing shading elements in this chapter, we refer to the term 'subject wall'. This is the wall to which shading is applied or which has the window the shading is applied to. Multiple shading devices can apply to a single subject wall but there may be a maximum limit which can be modelled, depending on the software tool.

Shading affects the subject walls and elements within the wall. Shading is described as either horizontal (including eaves, pergolas and verandahs; see [Section 10.2](#)) or vertical (including neighbouring buildings, privacy screens and wing walls; see [Sections 10.3](#) and [10.4](#)). Heritage listed vegetation must also be modelled as shading devices (see [Section 10.5](#)).

Shading from external structures can have a significant impact on the thermal performance in a NatHERS assessment. Shading data must be correctly entered to obtain a clearer assessment result.

10a Assessors must model all fixed and non-fixed shading features shown in the documentation. Where there is a limit to the number of shading devices that can be modelled in the software tool, model the three that have the largest impact on the rating. (**Tech Note clauses 10.1 and 10.2**)

The shade features to be modelled include shading devices from both the dwelling being assessed and nearby structures that will cause a sun or wind obstruction, such as neighbouring buildings (**10d**), retaining walls, fences and heritage listed trees (**10i**). If one shading device overshadows another shading device and the second does not contribute to additional shading impact, assessors may not need to model both when faced with limitations on the number of shading devices that can be modelled. For example, if the neighbouring building casts a shadow greater than the boundary fence shadow, the fence may not need to be modelled if it is not one of the three shading devices creating the largest impact on the rating.

If an assessor suggests shading devices to improve a rating, the client must update the documentation with the suggested inclusion before the assessor completes the assessment and issues the NatHERS Certificate. (**Tech Note clause 3.3**)

10.2 Horizontal shading

Horizontal shading is generally any external structure that provides shading to the dwelling in the horizontal plane, including eaves, verandahs, pergolas, carports and overhangs or balconies from upper levels. For detailed guidance on how to model shading features, assessors should refer to the relevant software tool manual. In some situations, there may be multiple shading devices, such as an eave and a pergola. It may not be necessary to enter the shading for both elements if the main shading device completely covers the other (**10a**). However, this may depend on the details of the shading scheme materials and transparency.

All covered outdoor living areas should be entered into NatHERS software tools as shade features, predominantly as eaves. Proposed permanent installations using construction-grade materials such as metal and timber, or fabric shading devices if shown on the documentation, should be modelled. If fabric shading devices are shown in the documentation and energy assessment, the device will need to be in place before building certification.

The terminology that assessors need to accurately model horizontal shading devices includes:

- **Height of the subject wall** – this is the distance from the finished floor level (FFL) to the top of the wall construction
- **Projection of the horizontal shading device** – this is the distance the shading device protrudes from the subject wall (see [Section 10.2.1](#))
- **Furthest point** – this is the maximum extent of shading projection from the subject wall. It may include parts of the structure not shown in the floor plan (e.g. the fascia board and gutter). For example, the furthest point in [Figure 10-1](#) is the roof eave (shading device). However, in [Figure 10-2](#), the furthest point is the window shade (window hood).

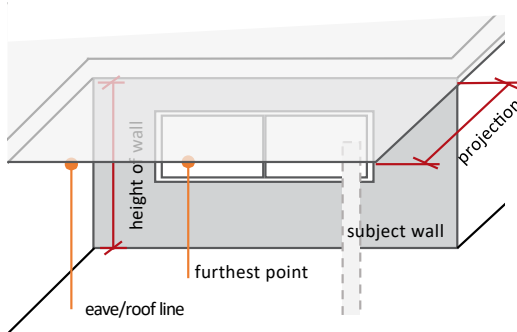

Figure 10-1: Shading terminology example 1 – indicative perspective view (left)

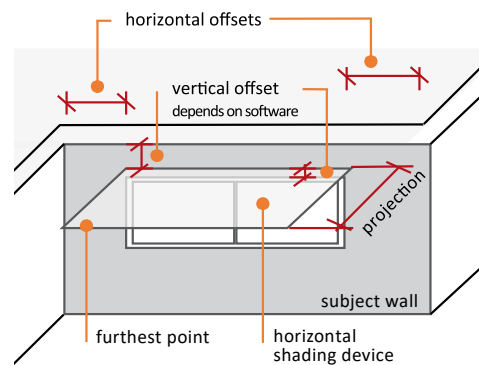

Figure 10-2: Shading terminology example 2 – indicative perspective view (right)

10.2.1 Projection for horizontal shading

Projection for horizontal shading is the distance (or width) that the shading device protrudes from the external surface of the subject wall to the furthest point of the shading structure. This should include the fascia width and may include the gutter – at the assessor’s discretion.

If the horizontal shade structure is non-rectangular, the projection may be calculated as an average.

Assessors should take into account the thickness or depth of the construction elements when modelling shading. This ensures the shading device is accurately modelled, including any construction obstructions of the sun on the dwelling and the solar impact.

- 10b** Assessors must model the width of an eave or horizontal shading device from the face of the external wall to the bottom of the fascia board or the underside of the outer edge of the horizontal shading device. Gutters may be modelled at the assessor’s discretion. (**Tech Note clause 10.3**)

Shading from the width of eaves is the horizontal distance from the wall to the furthest point on the shadow casting edge on the vertical plane, at right angles to the wall.

10c If the fascia board casts a greater shadow than the gutter, assessors must model shading from the bottom of the fascia.

The gutter is to be modelled at the assessor’s discretion. If the gutter detail is unknown a default value of 100mm can be applied.

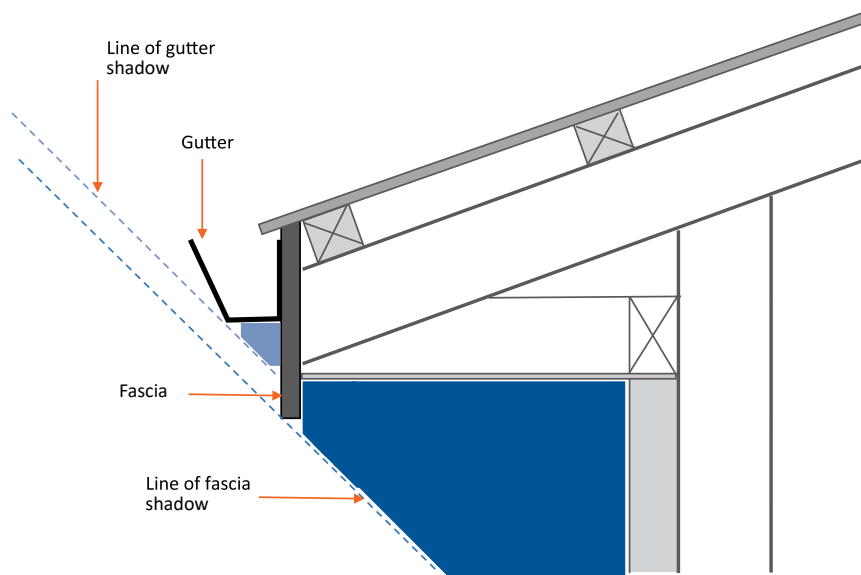

Figure 10-3: Gutter and fascia board shading impacts

10.2.2 Horizontal offset for horizontal shading

The horizontal offset for horizontal shading is the distance beyond the subject wall/window that the shading device extends. This is entered and treated differently depending on which software tool is being used and the type of shading device being entered, because some tools measure this based on the wall and others based on the window. Assessors are to refer to the relevant software tool manual and training resources to see how the tool treats this information, and for advanced modelling advice.

There are four methods used by the software tools to enter the horizontal offset:

- **Method A** – entered as one offset value taken from the right, assuming the user is inside the dwelling looking out (entered for each wall it affects). In [Figure 10-4](#), the horizontal shading device is shaded orange and the subject wall in which the shading is being applied to is shaded green. A positive offset would see the shading device extend further to the right than the subject wall while a negative offset would see the shading device begin to the left of this point (assuming the user is inside the dwelling looking out).

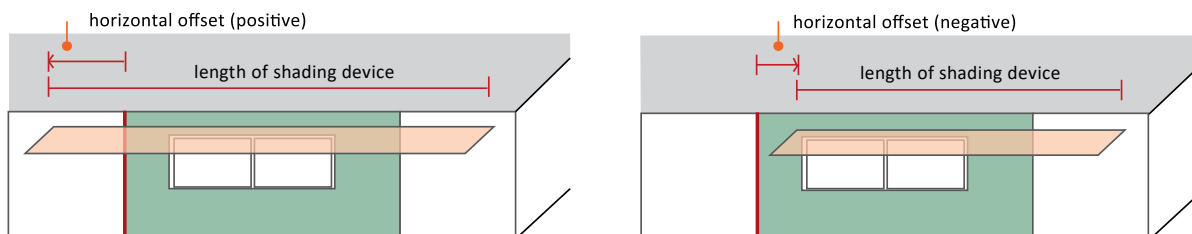

Horizontal shading device shaded orange and subject wall (*wall that shading is being applied to*) shaded green.

Figure 10-4: Method A – treatment of horizontal offset

10. SHADING

- **Method B** – entered as two values taken from the left and right of the device, assuming the user is inside the dwelling looking out. In [Figure 10-5](#), the horizontal shading device is shaded orange and the subject wall in which the shading is being applied to is shaded green. A positive offset would see the shading device extend further than the subject wall while a negative offset would see the shading device begin or end within the length of the subject wall.

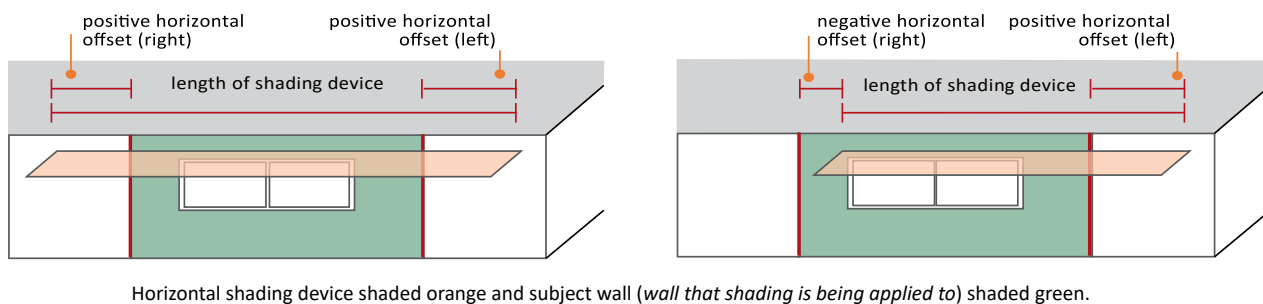

Figure 10-5: Method B – treatment of horizontal offset

- **Method C** – entered as two values from an axis reference point to each end of the shading device in plan view.
- **Method D** – automatically calculated for eaves based on roof/eave details entered.

10.2.3 Vertical offset for horizontal shading

The vertical offset of horizontal shading is the height between the shading device and the external top of the subject wall/window.

Whether the measurement is taken relative to the top of the wall or window depends on which NatHERS software tool is being used. In [Figure 10-7](#), if measuring relative to the wall the vertical offset would be negative as the shading device is below the top of the wall. However, if measuring relative to the window the vertical offset would be positive as the shading device is above the top of the window.

Figures [10-6](#) to [10-8](#) show examples of the difference in the vertical offset calculations for horizontal shading through a wall section and how these measurements differ depending on whether the offset is measured from the top of the wall or relative to the window. See the relevant software tool manual for modelling advice.

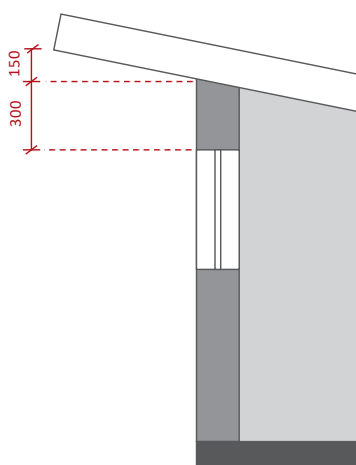

Relative to top of wall:

The shading element is located above the top of the wall and therefore the offset is positive.

Vertical offset = +150

Relative to top of window

The shading element is located above the top of the window and therefore the offset is positive.

Vertical offset = +450

Figure 10-6: Section example A – an eave vertical offset for horizontal shading

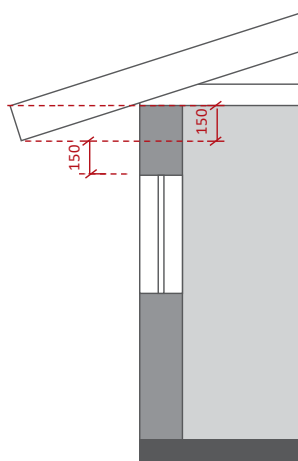

Relative to top of wall:

The shading element is located below the top of the wall and therefore the offset is negative.

Vertical offset = -150

Relative to top of window:

The shading element is located above the top of the window and therefore the offset is positive.

Vertical offset = +150

Figure 10-7: Section example B – an eave vertical offset for horizontal shading

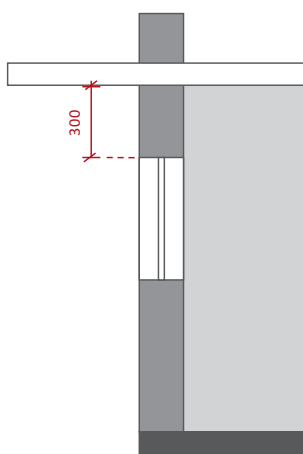

Relative to top of wall:

The shading element is located in line with the top of the wall and therefore the offset is zero.

Vertical offset = 0

Relative to top of window:

The shading element is located above the top of the window and therefore the offset is positive.

Vertical offset = +300

Figure 10-8: Section example C – an eave vertical offset for horizontal shading

10.3 Vertical shading

Vertical shading is any external structure that provides shading to the dwelling in the vertical plane and can be parallel or perpendicular to the subject wall/window including:

- privacy screens – see [Section 10.3.1](#)
- other walls in the dwelling (wing walls and parallel walls) – see [Section 10.3.2](#)
- adjacent structures (fences, other buildings) – see [Section 10.4](#)
- vegetation (heritage listed trees) – see [Section 10.5](#).

It is important that assessors consider changes in floor height when measuring screens and wing walls, as all vertical shading devices are relative to the floor height of the zone or room being assessed.

10. SHADING

The modelling requirements differ if the dwelling is located in the tropics, defined as north of the Tropic of Capricorn. In these locations the southern orientation is generally the maximum solar orientation.

10e Assessors must model all neighbouring shade features north of the Tropic of Capricorn. Shade features south of the Tropic of Capricorn between the midpoints SSE and S, and S and SSW (i.e. within the range of 168°45' to 191°15') need not be modelled but may be included for greater accuracy. (**Tech Note clause 10.5**)

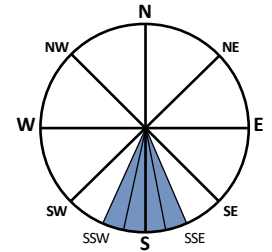

10.3.1 External screens (parallel vertical shading)

External screens are vertical shading devices and are modelled parallel to the subject wall of the dwelling. Examples of vertical shading devices include privacy screens, fences, retaining walls and other screens that may be detailed in the documentation. Neighbouring buildings are also modelled as vertical shading devices (see [Section 10.4](#) for more information on specific treatment and provisions). They may also include other walls of the subject dwelling that face the subject wall such as a parallel courtyard wall.

Assessors must model vertical shading devices such as external screens, neighbouring buildings and topographical features that obstruct the sun. For example, on level ground, assessors must model at least all single-storey neighbours and features within 10m and two-storey neighbours or features within 20m. (**Tech Note clause 10.4**)

The terminology assessors need to accurately model external screens includes:

- **Width of a vertical shading device** – this is the distance from one end of the shading device to the other.
- **Projection of a vertical shading device** – this is the distance from the external surface of the subject wall to the surface of the shading device. The software tool may display this as positive and negative, or left and right.
- **Horizontal offset of a vertical shading device** – this is the distance from the right-hand end (if the user is standing inside the dwelling) of the subject wall/window to the right-hand end of the shading device. If the right-hand end of the device is to the right of the end of the subject wall, it is a positive offset; if it is to the left it is a negative offset. Depending on the software tool, the vertical shading device may be drawn and the software calculates the horizontal offset automatically, provided it is connected to the relevant wall(s). Refer to [Figure 10-9](#).
- **Vertical offset of a vertical shading device** – this is the distance from the bottom of the wall or the window to the bottom of the screen, depending how the software operates. The vertical offset will be positive if it is above the building element (wall or window) and negative if below. Depending on the software tool, the vertical offset may be set as zero and assessors must adjust their modelling techniques to reflect this accurately. See software tool manuals for more information.

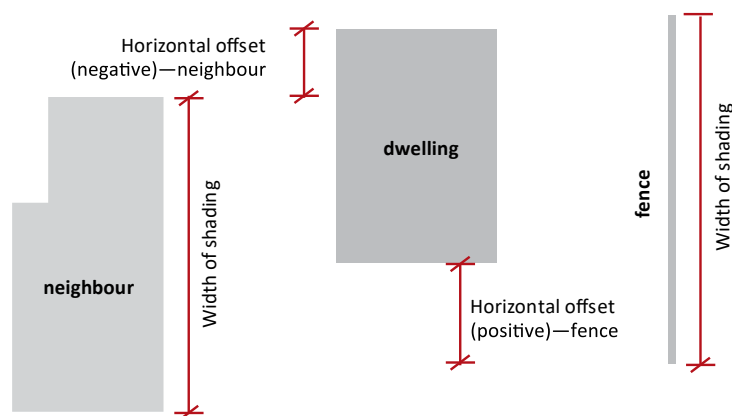

Figure 10-9: Site plan of vertical shading measurements

- **Height of the vertical shading device** – this is measured relative to the bottom of the subject wall of the storey or dwelling. An assessor must therefore consider this and any change in level or site slope when calculating the modelled height of vertical shading devices. See the software tool manual for modelling guidance and refer to [Figure 10-10](#).

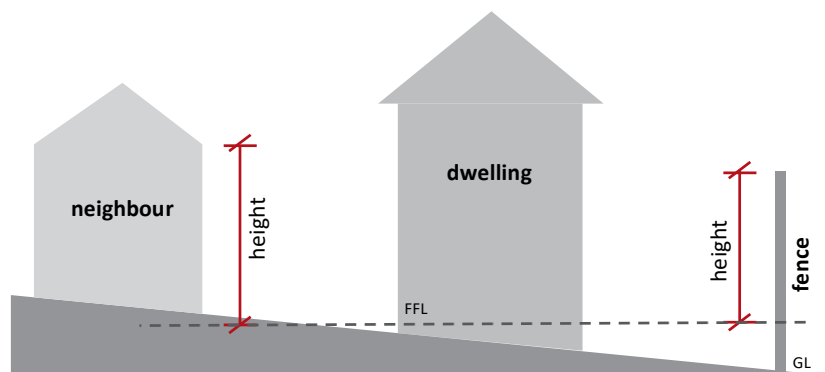

Figure 10-10: Example elevation of vertical shading device heights effected by site topography

Similar to the projection measurement of a horizontal shading device, the height of a vertical shading device is to be measured from the point where the greatest shadow will be created. For example, if the neighbour eave edge or roof line casts a greater shadow than the wall height, the height of the neighbour is to be modelled accordingly, rather than the height of just the closest neighbour wall.

For multi-storey buildings, vertical shading is usually measured relative to the bottom of the subject wall, unless the software tool allows for a negative vertical offset. For example, [Figure 10-11](#) shows:

- Modelling vertical shading of neighbour for the lower level (subject wall/window A) will have a height relative to the bottom of the wall on the ground level of the subject dwelling shown as height A.
- Modelling vertical shading of neighbour for the upper level (subject wall/window B) will have a height relative to the bottom of the wall on the second storey of the subject dwelling.

*The exception to this is if the assessor's software allows a negative vertical offset, i.e. instead of adjusting the shading device to be relative to the bottom of the subject wall, the assessor can enter that the shading device begins below the bottom of the shading device. For example, in [Figure 10-11](#), the modelling of shading for subject wall B, could be entered as height A but with a negative offset equal to the height of subject wall A.

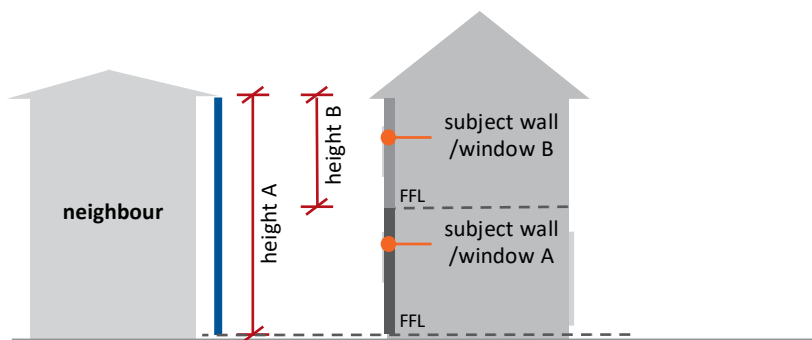

Figure 10-11: Elevation of vertical shading height differences for multistorey dwellings*

10. SHADING

This is similar to the treatment of Class 2 dwellings and will differ for each dwelling depending on its relative measurement to the vertical shading device. Two examples of this are shown in [Figure 10-12](#) (the subject dwellings being assessed are shown in orange). As mentioned above, if the software tool allows a negative vertical offset, this would be modelled slightly differently and assessors are advised to refer to their software tool manual.



Figure 10-12: Elevations of vertical shading height for Class 2 dwellings*

10.3.2 Wing walls (perpendicular vertical shading)

Wing walls or vertical fins are vertical shading devices that are attached perpendicular to the subject wall of the dwelling. Wing walls also affect the wind around and air flow through the dwelling and are therefore required to be modelled for all dwellings, including those located north of the Tropic of Capricorn. They can be another wall of the same dwelling or a balcony wall, fence or external construction protruding outside the dwelling envelope. Each wall section cannot have more than two wing walls, one at each end.

Wing wall location in the software is determined based upon the user standing inside the dwelling and looking out. If the wall is on the user's right-hand side it must be entered as a right wing wall, and vice versa.

Projection

Projection for wing walls is measured from the outside of the subject wall to the furthest point of the wing wall. When measuring the projection of a wing wall, assessors must ensure the projection (or length) includes the whole wing wall, which may include multiple wall sections. Wing walls are entered in different ways for graphic and non-graphic software tools.

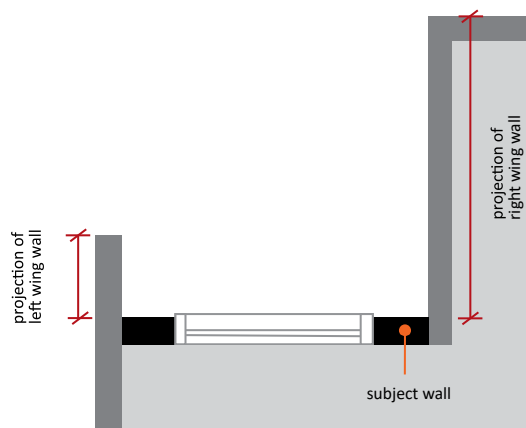

Figure 10-13: Wing wall projection

Depending on the software tool, it may automatically add wing walls for other walls of the same dwelling based on the measurement of an adjacent zone. In some cases, this measurement can be adjusted or removed when necessary, to correctly model or achieve more accurate results.

For example, in [Figure 10-14](#) the software tool may automatically calculate the effect of the adjacent zone (family room – green wall) as a wing wall to the subject wall (the kitchen – red wall) but has not included the impact of the bedroom – blue wall. The assessor needs to manually enter the combined length of the green and blue wall to correctly enter the effect of the wing wall on the subject wall.

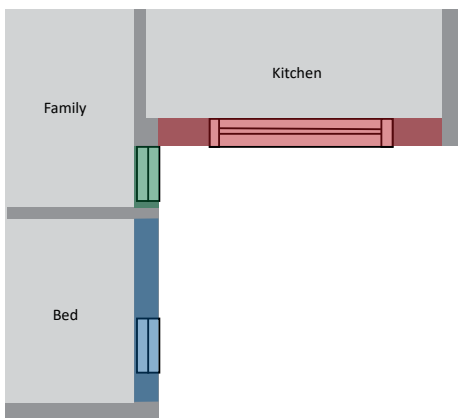

Figure 10-14: Wing wall shading for non-adjacent spaces

If the software tool does not automatically add wing walls, or the wing wall is something other than an adjacent dwelling wall, such as a retaining wall, assessors will need to enter wing wall information for each wall it may affect. For manual measurement, ensure the drawings are correctly to scale and suitable for measuring accurate distances relative to subject walls, or use nominated dimensions shown on the documentation.

Horizontal offset

The horizontal offset for wing walls is the distance from the edge of the subject wall/window (on the side that the wing wall projects) to the wing wall. For wing walls, offsets are always positive and relate to the distance from each end of the subject wall or window (assuming the user is standing in the dwelling looking out). The horizontal offset is relative to either the edge of the wall or the edge of the window, depending on the software tool used. [Figure 10-15](#) shows an example of how horizontal offset measurements differ depending on the software tool. See the software tool manual for more modelling advice.

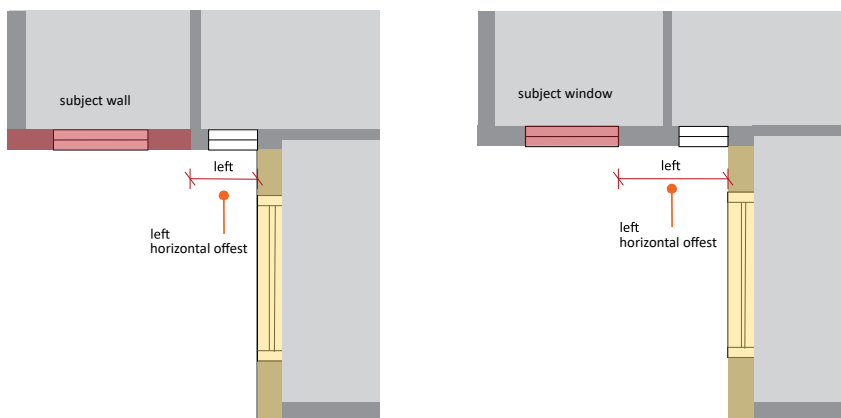

Figure 10-15: Horizontal offset wing wall measurement relative to subject wall or window

Vertical offset

The vertical offset for wing walls is the distance from the top of the subject wall/window to the top of the wing wall. This may be a positive or negative number and is the same as external screens (see Section 10.3.1). If the wing wall is lower than the subject wall/window, the vertical offset entered is negative while if it is above it is entered as a positive. If it is level, the vertical offset is 0. Again, this measurement differs depending on the software tool. Figure 10-16 shows an example of how vertical offset measurements differ depending on the software tool. See the software tool manual for more modelling advice.

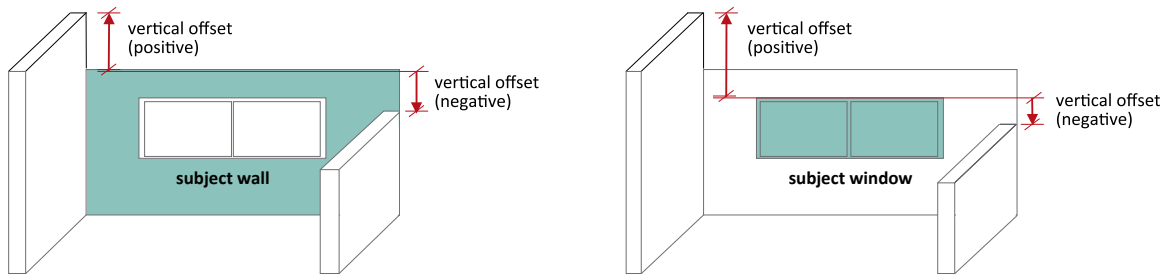

Figure 10-16: Vertical offset wing wall measurements relative to subject wall or window

Balcony walls

In the case of balconies, glazed verandahs, porticos or similar spaces, assessors must model these as wing walls on either side of the parent wall. This is because these are modelled primarily for the effect on ventilation, rather than that of solar transfer. These attached balcony or glazed verandah walls are assumed opaque in the Chenath engine.

10h Balconies or similar spaces with solid, glazed or partially glazed walls to either side of the parent wall are to be modelled as wing walls. Balcony walls with solid building elements directly in front of the parent wall are to be modelled as an external screen with 100% shading for the portion of the wall that is solid and 10% shading for the portion of the wall that is glazed.

Assessors must treat balcony walls with solid building elements directly in front of the parent wall as a vertical shading device (i.e. external screen) and model:

- 100% shading for the portion of the wall that is solid
- 10% shading for the portion of the wall that is glazed. (**Tech Note clauses 10.9 and 10.10**)

Outdoor living areas such as verandahs, porticos, sunrooms, winter gardens, conservatories or balconies may need to be included in the zoning of the dwelling if they are capable of being fully enclosed by solid construction elements (e.g. walls, windows, bi-fold or sliding doors) and are specified as conditioned spaces (i.e. mechanically heated or cooled). If the space is semi-open, enclosable only by fabric blinds for example, or shown as unconditioned, they are required to be modelled for shading purposes only. (**Tech Note clause 5.1**)

10.4 Neighbouring buildings

Neighbouring buildings may affect the dwelling, particularly in regard to shading. All features detailed on the documentation that may cause a sun obstruction must be modelled.

10d Assessors must model neighbouring buildings and surrounding topographical features which obstruct the sun, including considering the impact of level changes and retaining walls.

It is best practice to model all sun obstructions to encourage accurate modelling. If a feature may cause a sun obstruction because of topography, building site levels and the location/orientation of the dwelling, it must be modelled. Assessors are to use their judgement about the impact of such features and keep a record of the supporting information.

Where the documentation does not show surrounding features and neighbours, assessors must investigate further to establish if any are present that will cause an obstruction to the dwelling being assessed.

10f Where information on neighbouring buildings is not shown on the documentation, assessors must request the documentation be updated or obtain supporting evidence of existing neighbouring buildings for the purposes of modelling, e.g. Google maps. (**Tech Note clause 10.6**)

Assessors could request this information from the client, either as supporting documentation or as updated documentation drawings. Alternatively, the assessor could research online platforms such as maps and street view, and this information can be considered for the purpose of NatHERS modelling. If assessors source this information other than from the documentation drawings, supporting evidence must be obtained and kept.

10g Where neighbouring buildings are unknown, because the dwelling is located in a new development site, NatHERS Technical Note provisions must be applied. (**Tech Note clause 10.7**)

The provisions to apply are as follows:

- The neighbouring building's footprint will match the design being modelled having the same floor, wall and roof height (e.g. a two-storey dwelling should presume a two-storey neighbour), length, width and orientation as the one being modelled
- The **setback from the street** is to have the same setback from the street as the dwelling being rated
- The side and rear **fence heights** are to be 1.8m if local planning requirements are unknown
- **Height changes** are to include all known level changes between lots that will affect the rating
- **Neighbouring building setbacks** must be located parallel to the fence line and at a distance equal to the shortest distance between the rated building and the fence line. This setback is to be calculated independently for each boundary where a neighbour is required to be modelled. Ignore dwellings to the south except if the dwelling is north of the Tropic of Capricorn (see **10e**).

10. SHADING

Figures 10-17, 10-18 and 10-19 show examples of how to apply default settings when information for the neighbouring dwellings are unknown. The dark shaded area is the dwelling being modelled while the light grey shapes refer to the default neighbouring dwellings.

Dimensions **a** and **b** represent equal distance setbacks from the shared boundary line for neighbours to each side of the dwelling. The dimensions are taken from the shortest distance between the dwelling and boundary, and this should remain parallel to the boundary line for the length of the dwelling.

Dimension **c** in both figures shows the rear setback to be calculated using the same method to dimensions **a** and **b**. Dimensions **a**, **b** and **c** are to be calculated independently based on each of their respective boundaries.

Dimension **d** demonstrates applying the same setback from the street for each neighbouring dwelling to that of the dwelling being modelled.

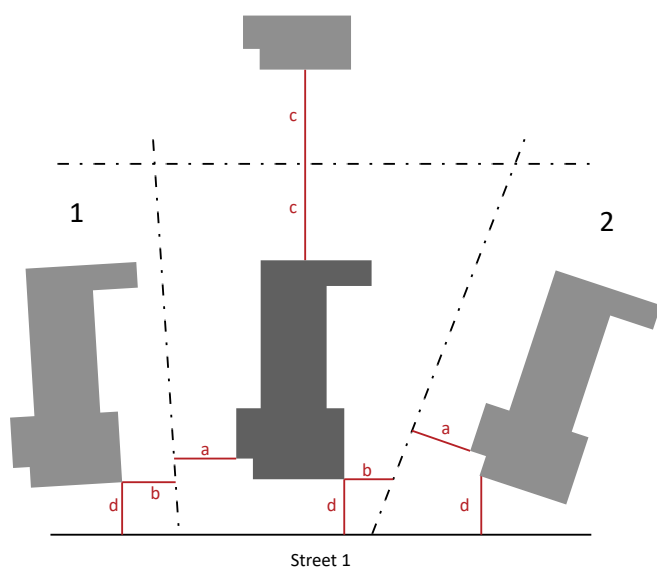

Figure 10-17: Applying neighbouring buildings setback example 1 (left)

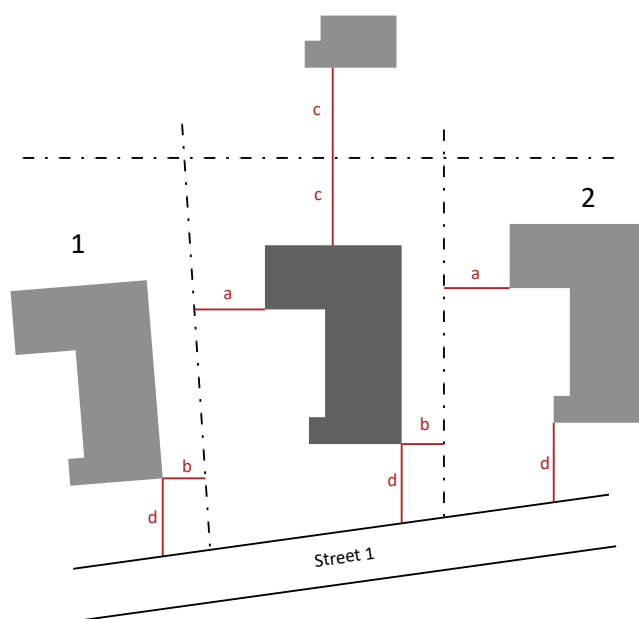

Figure 10-18: Applying neighbouring buildings setback example 2 (right)

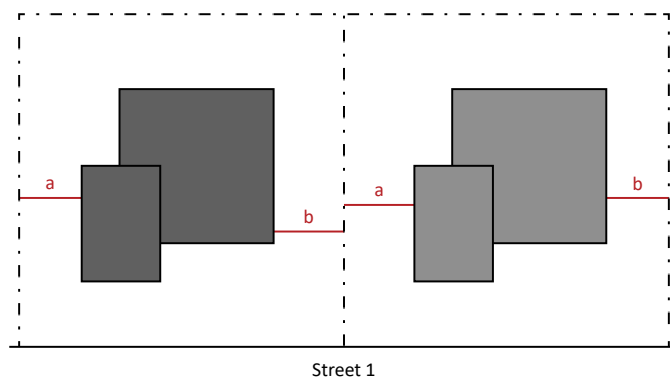

Figure 10-19: Applying neighbouring buildings setback with garage example 3

10.5 Vegetation

10i Only trees with an existing preservation order or heritage protection must be modelled. No other vegetation may be modelled as shade. The design documentation must include:

- the tree canopy drawn to scale or dimensioned
- existing preservation order or heritage listing. (**Tech Note clause 10.11**)

Only the shading effects from trees with an existing preservation order or heritage protection are to be modelled in NatHERS assessments for compliance purposes.

To model vegetation in NatHERS software tools, the assessor must create a vertical shading feature measuring the full tree height from the ground and the width of the tree canopy (see [Figure 10-20](#)). The canopy width used for the 'shading box rectangle' and the species shading schedule used to reflect the monthly shading factor to allow for deciduous trees should be provided by the client in the supporting information.

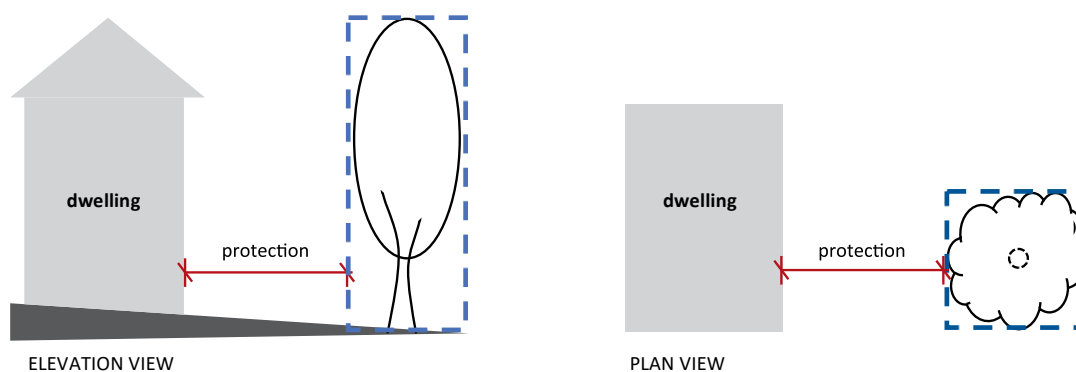
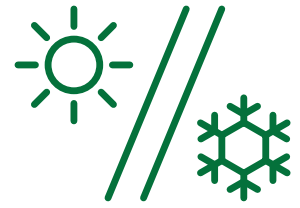

Figure 10-20: Example guidance for modelling the extent of heritage listed trees



11

Thermal bridging

IN THIS CHAPTER

11.1	Overview of thermal bridging	128
11.2	Modelling thermal bridging	132
11.3	Default steel framing specifications	133
11.4	Modelling thermal breaks and airspaces adjacent to framing	134
11.5	Additional constructions modelling guidance	137



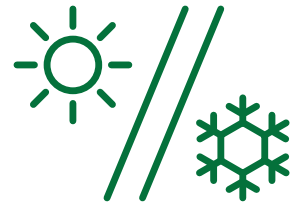

This chapter explains thermal bridging and includes details on how to model thermal bridges in walls, floors, ceilings and roofs. Thermal bridging modelling is only undertaken for dwellings with steel framed construction.

It also explains thermal breaks and outlines the requirements for how to model these, including the default values to use when thermal break specifications are not included in design documentation.

Summary of key requirements

This handbook is intended to be a helpful resource for all assessors. When conducting assessments, assessors must still follow the requirements of the current NatHERS Technical Note and the relevant state or territory requirements.

- 11a** Thermal bridging only applies to repeating steel frame elements where insulation is interrupted. Thermal bridging is applied in walls, ceiling and floors as outlined in [Table 11-1](#).
- 11b** Assessors must model thermal bridging that occurs in the design documentation in accordance with the software's instructions. If the software has the functionality to select specific metal framing specifications, these may be used to apply thermal bridging to the relevant elements. When steel framing details are not supplied assessors must model the default steel framing specifications outlined in [Table 11-2](#).
- 11c** Thermal breaks must have a minimum R-value of R0.2 as specified by the 2022 National Construction Code (NCC).
- 11d** Assessors must model thermal breaks according to the NCC 2022 requirements and as specified in the design documentation in accordance with the software's instructions. When thermal breaks are required as per the NCC 2022 provisions but are not specified in the design documentation, assessors must model the default value R0.2 and refer to [Table 11-3](#).
- 11e** Assessors must enter an additional R0.16 air gap to thermally bridged construction types detailed in this chapter.

11.1 Overview of thermal bridging

11.1.1 What is a thermal bridge?

- 11a** Thermal bridging only applies to repeating steel frame elements where insulation is interrupted. Thermal bridging is applied in walls, ceiling and floors as outlined in [Table 11-1](#).

A thermal bridge, also known as a heat bridge or a cold bridge, is a part of the building envelope with lower thermal resistance than surrounding areas. This enables heat to pass more easily through the building envelope.

11. THERMAL BRIDGING

It typically occurs where insulation is interrupted by a structural element that has a higher thermal conductivity than the surrounding insulating material.

Any solid material can act as a thermal bridge. It can be a single structural element – a steel beam for example. It can also be a combination of elements that are in direct contact with each other – for example, external cladding fixed directly to a structural frame that itself is directly fixed to the internal lining or is open to the internal environment. See [Figure 11-1](#) below.

The bridge's thermal conductivity will determine how much heat or cold it can transfer. For example, steel has a higher thermal conductivity than common structural timber so it creates a stronger pathway of least resistance for heat or cold to transfer.

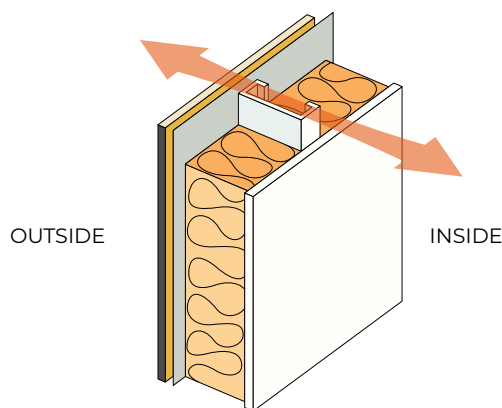

Figure 11-1: Direct-fixed steel framed wall showing the thermal path of least resistance through the steel frame, with no thermal break (non-compliant construction).

11.1.2 Impacts of thermal bridging

Thermal bridges can reduce the energy efficiency of a building by transferring heat or cold into or out of a building. This can increase the energy needed to heat or cool the building.

Thermal bridges can also cause condensation when warm moist inside air meets the cold surface of the bridge. If the temperature of the thermal bridge material falls below the dewpoint, moisture can condense on the inner surface. This can lead to mould growth and, if excessive, may also damage structural elements within a building over time.

In the case of a non-compliant direct-fix clad external wall (seen in [Figure 11-2](#) below), the temperature of the internal lining in contact with the steel frame will be closer to the outside temperature. On a cold day, the temperature of this section of the internal lining may dip below the dewpoint of the indoor air causing condensation to form. This may lead to localised problems such as patterned staining if not mitigated against.

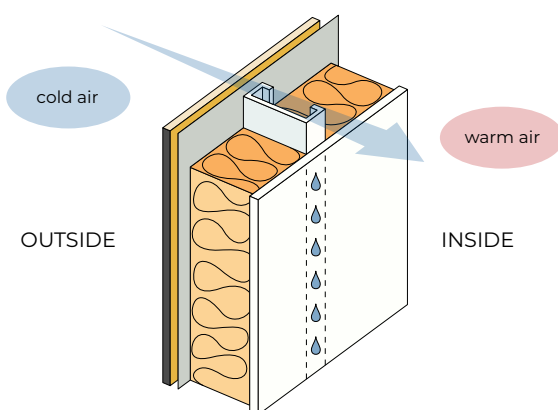

Figure 11-2: Condensation may form on the internal lining if thermal bridging is not mitigated (non-compliant construction).

11. THERMAL BRIDGING

11.1.3 What is a thermal break?

A thermal break or a thermal barrier includes any material that interrupts the conduction of heat or cold between building elements. Thermal breaks reduce the effects of thermal bridging, reducing heat loss and/or gain and subsequently improving the overall energy efficiency of a building. See [Figure 11-3](#) and [Figure 11-4](#) below.

As defined by the NCC 2022, thermal breaks are materials with an R-value greater than or equal to R0.2 that are installed between and separate the cladding from the frame. This includes, but is not limited to:

- materials such as timber battens greater than or equal to 20mm thick
- expanded polystyrene strips greater than or equal to 12mm thick
- continuous thermal breaks such as polystyrene insulation sheeting deemed to achieve an R-value greater than or equal to R0.2

The NCC provisions require thermal breaks for walls to be installed at all points of contact between the external cladding and the metal frame. This is in scenarios when the wall:

- does not have a wall lining or has a wall lining that is fixed directly to the metal frame; and
- is clad with weatherboards, fibre-cement or the like, or metal sheeting fixed to the metal frame. See [Figure 11-3](#) below.

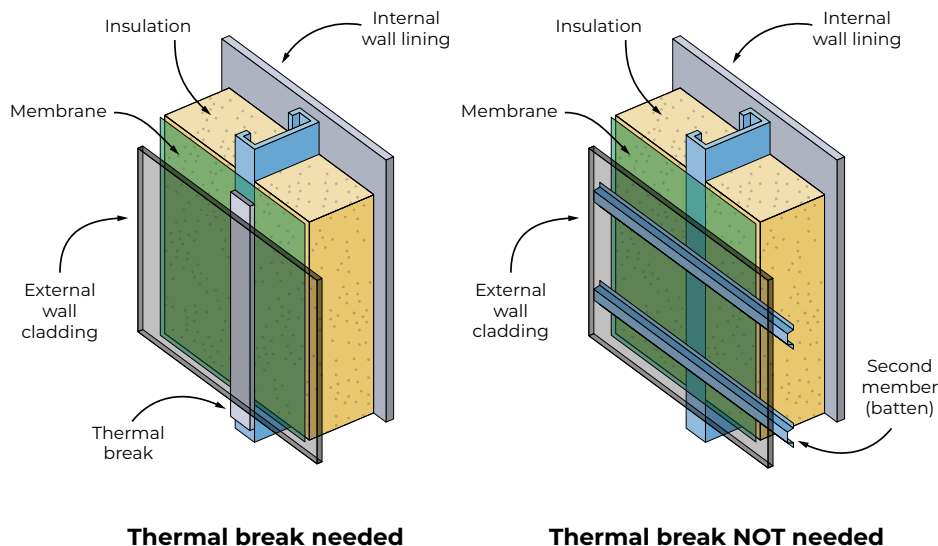

Figure 11-3: A minimum R0.2 thermal break is required to be installed at all points of contact between the external cladding and the metal frame when lightweight cladding is attached to the same steel member as the internal lining in an insulated steel framed wall.

Image source: The NCC Housing energy efficiency Handbook provided by the Australian Building Codes Board under the CC BY 4.0 licence, March 2023.

The NCC provisions require thermal breaks for roofs to be installed between the metal sheet roofing and its supporting metal purlins, metal rafters or metal battens. This is in circumstances where:

- the metal sheet roofing is directly fixed to metal purlins, metal rafters or metal battens; and
- the roof does not have a ceiling lining, or has a ceiling lining fixed directly to those metal purlins, metal rafters or metal battens. See [Figure 11-4](#) below.

11. THERMAL BRIDGING

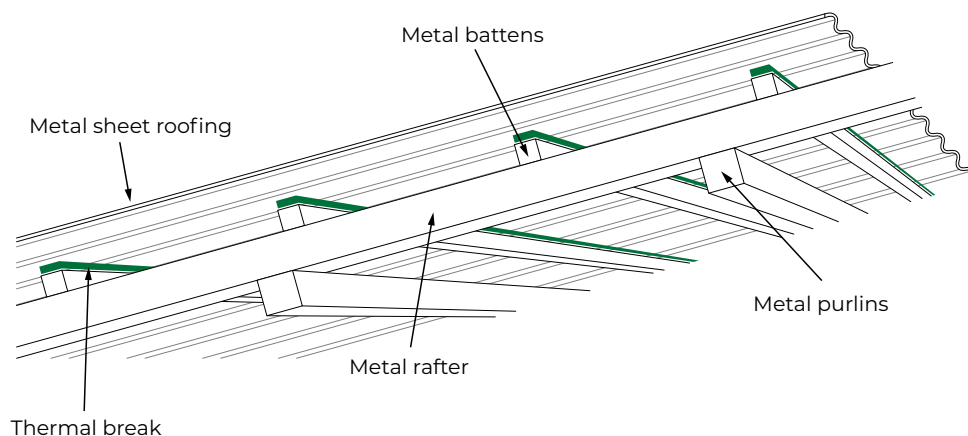

Figure 11-4: A minimum R0.2 thermal break in a roof construction (insulation not shown).

Image source: The NCC Housing energy efficiency Handbook provided by the Australian Building Codes Board under the CC BY 4.0 licence, March 2023.

11.1.4 Thermal bridging in NatHERS

NatHERS was modified to include a thermal bridging function to align with the NCC 2022 requirements.

The current thermal bridging implementation methodology can be found in [Thermal Bridging Implementation in AccuRate Report \(2023\)](#). This report also includes a comparison of energy rating results between the previous method and the current method. Thermal bridging impacts are based on the calculation method outlined in standard NZS 4214:2006 *Methods of determining the total thermal resistance of parts of buildings*.

In 2020 in preparation for the thermal bridging updates to the NCC, a [Thermal Bridging Report \(2020\)](#) was published by CSIRO. This report includes a set of thermal bridging default parameters and draft modelling guidance, as well as the impact of applying defaults on residential building energy ratings.

As per NCC 2022 requirements, modelling of thermal bridging in NatHERS is only required for repeating steel framed elements. It is not applied to timber framed constructions. The performance of steel framed buildings must now achieve a similar performance to timber framed buildings; i.e. thermal bridging calculations will be based on a comparison to timber framing as a benchmark rather than the actual performance of steel frames. Assessors will have the option of adding thermal breaks and/or improving other elements of the home's design to offset any negative impacts associated with thermal bridging. [Figure 11-5](#) shows examples of repeating steel frame elements for the roof, wall and floor.

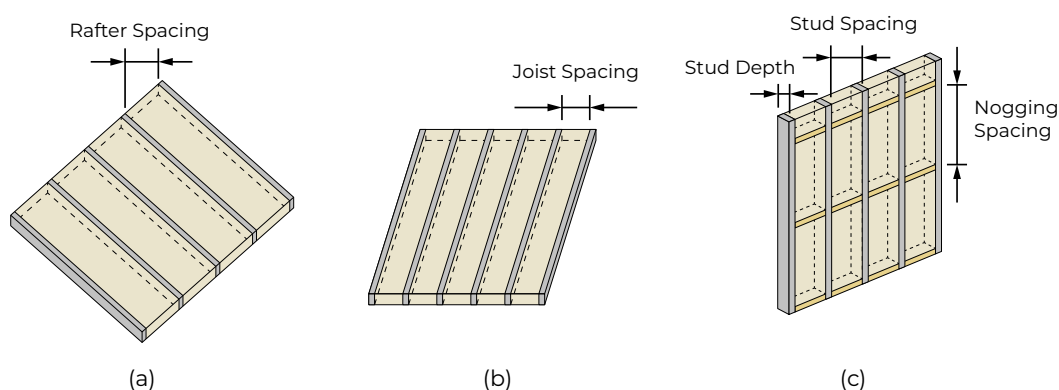

Figure 11-5: Diagrammatic illustrations of thermal bridging in insulated, repeating steel frame elements for (a) a roof without a roof cavity, (b) a floor or ceiling with a roof cavity and (c) a wall.

11.2 Modelling thermal bridging

11a Thermal bridging only applies to repeating steel frame elements where insulation is interrupted. Thermal bridging is applied in walls, ceiling and floors as outlined in [Table 11-1](#).

11b Assessors must model thermal bridging that occurs in the design documentation in accordance with the software's instructions. If the software has the functionality to select specific metal framing specifications, these may be used to apply thermal bridging to the relevant elements. When steel framing details are not supplied assessors must model the default steel framing specifications outlined in [Table 11-2](#).

Thermal bridging modelling in NatHERS applies to repeating steel frame elements only where insulation is interrupted by the steel framing. As a minimum, assessors must apply thermal bridging to the steel framed building elements outlined in [Table 11-1](#) (**Tech Note clause 11.1 and Table 6**) and illustrated in [Figures 11-6 and 11-7](#). Assessors may also model the effects of thermal bridging for additional features if they exist, to improve the thermal modelling accuracy and if the software allows using appropriate thermal modelling techniques.

Table 11-1: Building elements and thermal bridging modelling

Building element	When to apply thermal bridging
External walls (Class 1)	Apply to all Ignore external walls of attached unconditioned garage
Apartment walls (Classes 2 & 4)	Apply if adjacent to non-neighbour spaces such as stair wells, unconditioned corridors, car parks and other shared public spaces Ignore if adjacent to neighbour
Internal walls	Apply if adjacent to: <ul style="list-style-type: none"> unconditioned garages roof spaces subfloor zones Ignore all other internal walls
Ceilings	Apply to ceilings: <ul style="list-style-type: none"> below a roof space directly attached to a roof (e.g. flat, skillion, cathedral) non-neighbour public areas Ignore if adjacent to another zone (excluding roof space)
Floors	Apply to suspended floors above: <ul style="list-style-type: none"> outside air (including sub-floors) unconditioned garage non-neighbour public area Ignore if: <ul style="list-style-type: none"> in-between floors of multi-level Class 1 building adjacent to neighbour zone

11. THERMAL BRIDGING

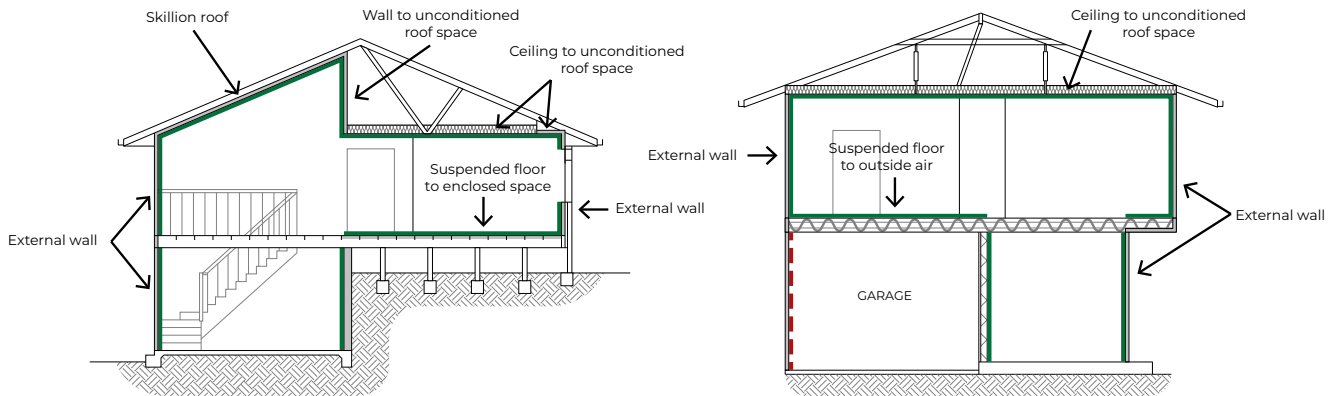

Figure 11-6: Class 1 examples of steel frame building elements that require thermal bridging to be modelled outlined in solid green lines (as opposed to the dashed red line).

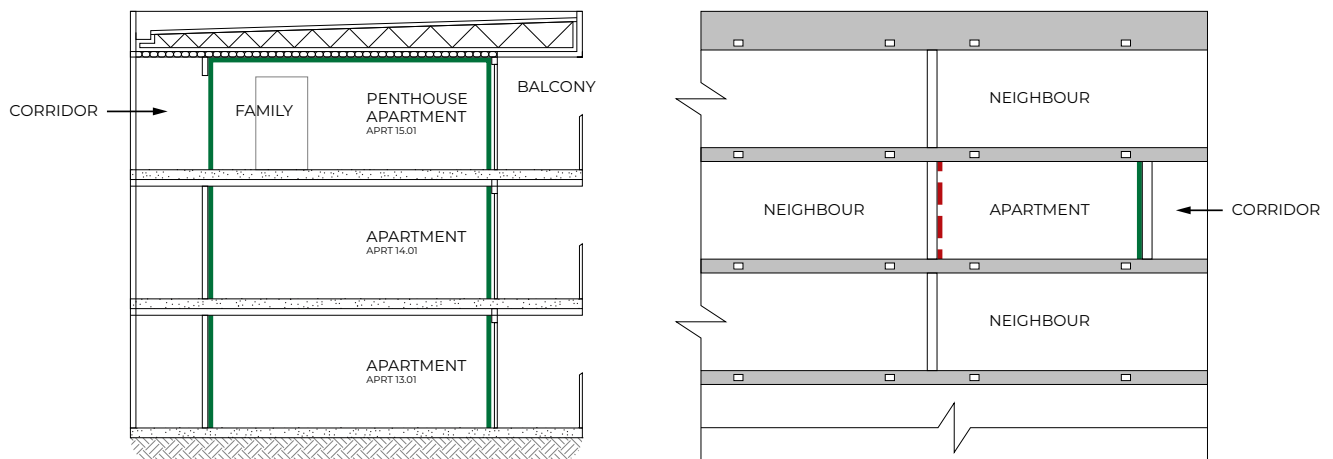

Figure 11-7: Class 2 & 4 examples of building elements that require thermal bridging to be modelled outlined in solid green lines (as opposed to the dashed red line).

11.3 Default steel framing specifications

Assessors must model thermal bridging that occurs in the design documentation in accordance with the software's instructions. If the software has the functionality to select specific metal framing specifications, these may be used to apply thermal bridging to the relevant elements. When steel framing details are not supplied assessors must model the default steel framing specifications outlined in [Table 11-2](#). (**Tech Note clause 11.3 and Table 7**)

11. THERMAL BRIDGING

Table 11-2: Default steel framing specifications

Building Element	Frame Element	Steel Frame Dimensions
Ceiling/roof without roof cavity	Rafter	200 x 75mm
	Rafter spacing	900mm
	Flange width	75mm
	Base metal thickness	1.5mm
Ceiling with roof cavity including raftered roofs with concealed rafters or horizontal ceilings Apply to edge batts & centre batts	Joist	90 x 40mm
	Joist spacing	900mm
	Flange width	40mm
	Base metal thickness	0.75mm
Wall	Stud	90 x 40mm
	Stud spacing	600mm
	Flange width	40mm
	Base metal thickness	0.75mm
	Nogging dimensions	90 x 40mm
	Nogging spacing	1200mm
Floor	Joist	100 x 50mm
	Joist spacing	450mm
	Flange width	50mm
	Base metal thickness	1.5mm

Flange width and base metal thickness measurements are illustrated in [Figure 11-8](#) below.

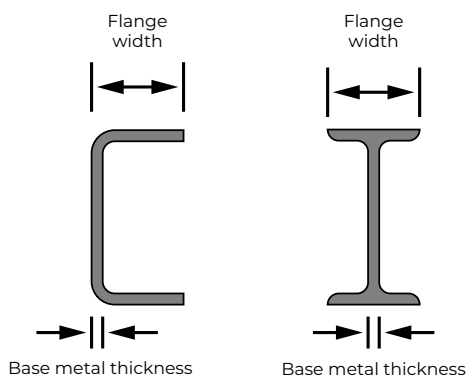

Figure 11-8: Flange width and base metal thickness measurements.

11.4 Modelling thermal breaks and airspaces adjacent to framing

11.4.1 Thermal breaks

11c Thermal breaks must have a minimum R-value of R0.2 as specified by the 2022 National Construction Code (NCC).

Thermal breaks can only be modelled after thermal bridging has been applied. As per the NCC 2022 requirements, thermal breaks must have an R-value greater than or equal to R0.2, installed at all points of contact between the external cladding and the frame.

11. THERMAL BRIDGING

11d Assessors must model thermal breaks according to the NCC 2022 requirements and as specified in the design documentation in accordance with the software's instructions. When thermal breaks are required as per the NCC 2022 provisions but are not specified in the design documentation, assessors must model the default value R0.2 and refer to [Table 11-3](#).

Assessors must model any thermal breaks specified in the design documentation in accordance with the software's instructions. When thermal breaks are not specified in the design documentation, assessors must model the default values as specified in [Table 11-3](#). (**Tech Note clause 11.4 and Table 8**)

Table 11-3: Default thermal breaks and airgaps

Element	Construction	Thermal break minimum R0.2 ¹	Air gap R0.16 ²
External walls	Cavity ³	No	Yes
	Lightweight cladding ⁴ (direct fixed to the same insulated steel member as the wall lining, or does not have a wall lining)	Yes	No
	Lightweight clad (battened out by secondary members fixed perpendicular to the frame)	No	Yes
Internal walls to unconditioned space/s	Cavity	No	Yes
	Lightweight cladding (direct fixed to the same insulated steel member as the wall lining, or does not have a wall lining)	Yes	No
	Lightweight cladding (battened out by secondary members fixed perpendicular to the frame)	No	Yes
Metal sheet roofs	Above attic space	No	No
	Skillion or cathedral metal roof with metal sheet roofing and ceiling lining directly fixed to the main frame	Yes	No
	Skillion or cathedral metal roof battened-out by secondary metal members, with or without a ceiling lining	Yes	Yes 1 x R0.16 if roof or ceiling battens are present
Ceilings	Ceilings below attic spaces	No	Yes
Floors	Suspended floor above and exposed to an enclosed subfloor space e.g. no bottom lining	No	Yes
	Suspended floor above unconditioned garage, outdoor air or non-neighbour	No	Yes

1 NCC 2022 compliant construction includes a minimum thermal break R0.2.

2 If the software has the functionality.

3 E.g. masonry or brick veneer.

4 Lightweight cladding includes weatherboard, fibre-cement or metal clad.

11. THERMAL BRIDGING

11.4.2 Air gaps

11e Assessors must enter an additional R0.16 air gap to thermally bridged construction types detailed in this chapter.

To align NatHERS modelling with established thermal bridging calculation methods, assessors must enter an additional R0.16 air gap to the following, referring to individual software guidance notes for specific modelling instructions. See [Table 11-3](#) above (**Tech Note clause 11.4 and Table 8**):

For walls:

Apply an R0.16 air gap to any thermally bridged external cavity walls⁵ or thermally bridged internal cavity walls adjacent to an unconditioned garage or roof spaces. See [Figure 11-9](#) below.

Apply an R0.16 air gap to any lightweight clad⁶ wall construction where the internal or external cladding is not directly fixed to the main steel frame, for example fixed via secondary metal battens perpendicular to the frame. See [Figure 11-9](#) below.

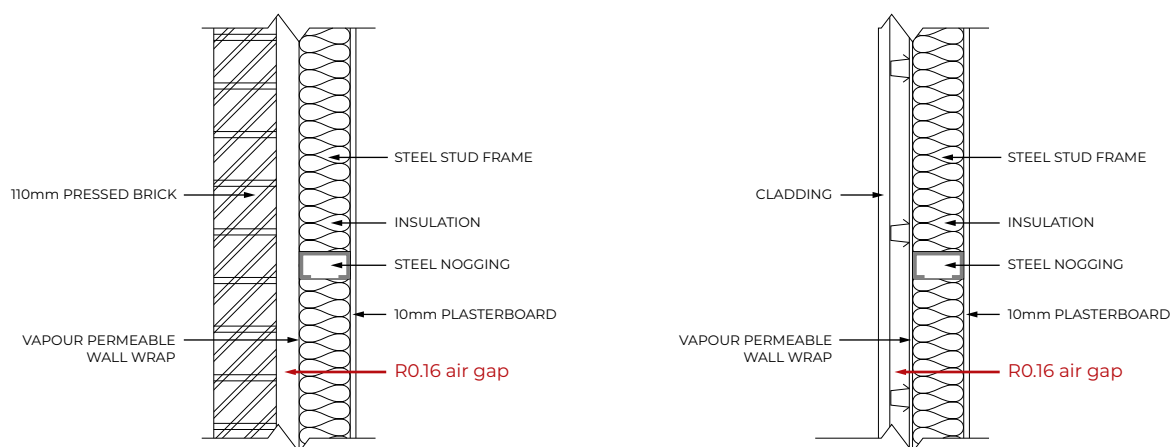

Figure 11-9: Modelling air gaps in steel framed brick veneer and battened out lightweight clad walls.

For roofs:

Skillion or cathedral roof – apply an R0.16 air gap option if metal roof battens or metal ceiling battens are shown in the design documentation. See [Figure 11-10](#) on the right.

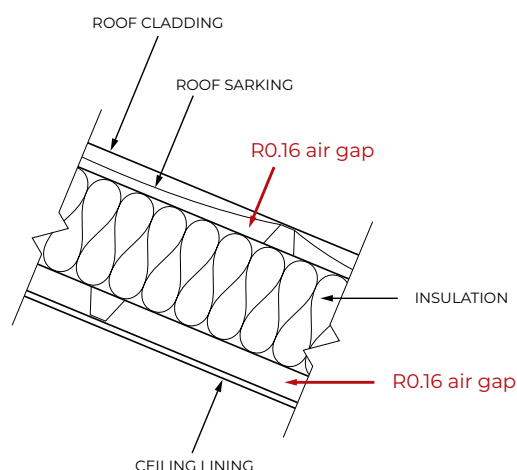

Figure 11-10

⁵ For example, masonry or brick veneer

⁶ Lightweight cladding includes weatherboard, fibre-cement or metal clad

11. THERMAL BRIDGING

Ceiling with unconditioned roof space above – apply an R0.16 air gap if secondary metal ceiling battens are shown in the design documentation. Ceiling battens are typically used for ceiling frame spacing greater than 600mm (i.e. 900/1200/1500 centres). See [Figure 11-11](#) below.

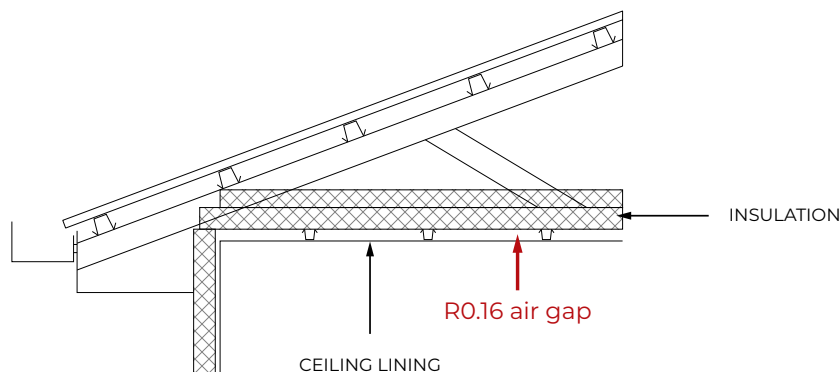

Figure 11-11

For floors:

Apply an R0.16 air gap to any thermally bridged suspended floor which is above, and exposed to, an enclosed subfloor space, i.e. no bottom lining. This takes account of the benefit provided by the sub-floor airspace in reducing thermal bridging of the frame. See [Figure 11-12](#) below.

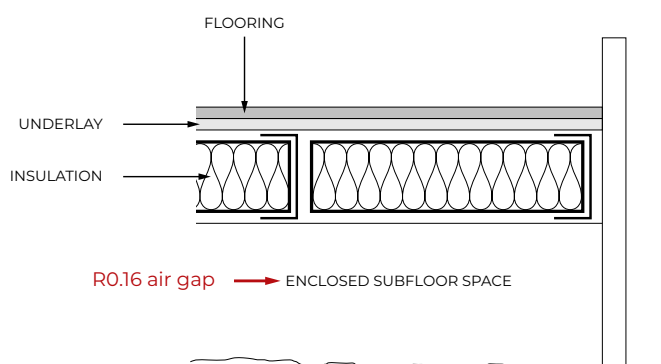

Figure 11-12

11.5 Additional constructions modelling guidance

11.5.1 Continuous insulation/continuous thermal break

If continuous insulation is applied directly adjacent to and touching the steel frame, this should be modelled by:

1. modelling the insulation according to the software's instructions, e.g. as a separate construction layer; and
2. ticking the thermal break box R0.2.

11.5.2 Roof blankets

Roof blankets do not currently need to be modelled for thermal bridging.



IN THIS CHAPTER

12.1	Background	140
12.2	Conducting a NatHERS Whole of Home assessment	143
12.3	Whole of Home NatHERS Certificate	159
12.4	How to improve a rating	159
12.5	When to re-simulate the NatHERS Whole of Home assessment	160

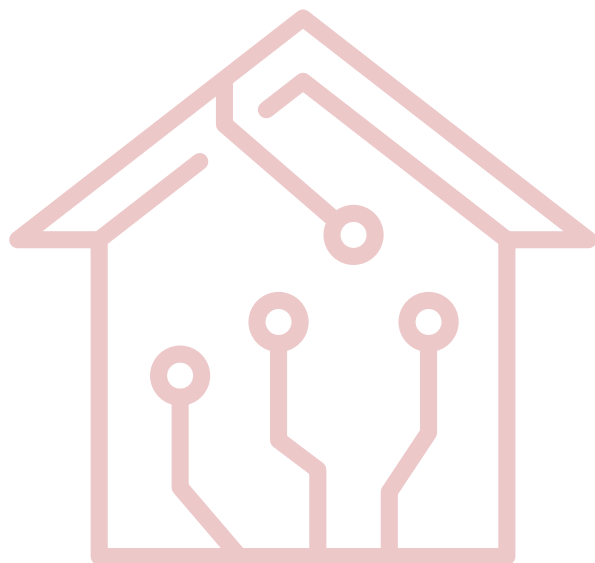



This chapter provides details of Whole of Home assessments, the performance ratings, default values and a step-by-step guide for undertaking the assessment. It also includes a Whole of Home data checklist template so assessors can easily obtain the information they need from their clients, plus tips on how to improve a rating and information on what triggers an assessment revision.

Summary of key requirements

Heating and cooling

- 12a** Assessors must model the main and any additional heating and cooling appliance type for each NatHERS designated conditioned zone as shown on the design documentation. If not specified, the default appliance type and performance levels/star ratings in the NatHERS Technical Note must be selected.
- 12b** If the tool allows only one appliance per zone to be entered, assessors must use the main heating and cooling appliance in the zone.
- 12c** If the tool flags that the entered efficiency is higher than what is known to be available in the Australian market, the assessor must notify the designer and update the efficiency in the assessment to reflect the documentation.
- 12d** If no appliance is specified, the default heating or cooling appliance shown in the NatHERS Technical Note is applied to conditioned zones.
- 12e** In the case of a ducted system, assessors must define all zones it services.

Hot water

- 12f** Assessors must enter the hot water system specified by the design documentation. If no hot water system is specified, assessors must select the appropriate default value shown in the NatHERS Technical Note.
- 12g** Reassessment of the Whole of Home performance rating is required after the initial assessment for the following reasons: solar thermal boost fuel change, hot water technology change, reduction in STCs.

Pools and spas

- 12h** If a pool and/or spa are present in the design documentation, assessors must enter the volume or surface area (to calculate the volume), pump type and star rating. If the pump type or pump star rating are unknown, assessors must enter default values.

12. APPLIANCES (WHOLE OF HOME ASSESSMENTS ONLY)

Solar photovoltaic

- 12i** Only solar photovoltaic (PV) renewable energy systems are included in Whole of Home calculations. Assessors must enter the array size, inclination, direction and inverter capacity as provided in the design documentation. Where system values are unknown, apply the defaults provided in the NatHERS Technical Note.
- 12j** NatHERS cannot specify centralised PV systems for Class 2 buildings or Class 4 parts of a building.
- 12k** Assessors must enter the battery technology type and size provided in the design documentation. Currently only lithium-ion, lead-acid and zinc-bromine battery types can be entered.

Lighting

- 12l** Assessors must enter the lighting power density in the design documentation. If unknown, apply the default value of 5W/m².

Pools and spas

- 12m** Assessors must enter the energy source(s) of cooking appliances. If the energy source(s) are unknown, defaults must be modelled and noted in the 'additional notes' field of the certificate.

12.1 Background

12.1.1 About Whole of Home

Using NatHERS thermal assessments to meet regulatory requirements in the National Construction Code, new homes have been designed and built to achieve minimum thermal comfort standards since 2006. The NatHERS Whole of Home requirements build on the thermal assessment to achieve a holistic approach. Rating the appliances specified for the home reduces overall home energy use by improving appliance efficiency and incentivising uptake of onsite energy generation.

The NatHERS Whole of Home rating considers the energy used by heating, cooling, cooking and plug-in appliances as well as hot water systems, lighting and pool and spa equipment, alongside the existing thermal star rating.

Whole of Home ratings help homeowners make cost-effective choices about the design and appliances for their new home which results in lower long-term energy costs. Homeowners, designers and builders can explore the trade-offs and benefits of selecting different technologies, appliance efficiencies and thermal performance to create a home and appliance design that works for them and their budget.

There are many appliance combinations that can be used to get a high Whole of Home rating. An efficient water heating system and appropriately sized heating or cooling systems can save money and ensure the home is comfortable and resilient in hot and cold climates. On-site renewable energy generation can also help off-set the home's energy use.

Understanding how the assessment is calculated will help designers and assessors maximise the performance rating for a dwelling.

Whole of Home ratings are based on societal cost and a net energy value (i.e. cost) calculation which includes energy import and export. They account for time of energy use and penalise appliances used at peak energy consuming times. The ratings are influenced by the environmental conditions where the home is located and the energy prices and carbon intensities of appliance fuel types for that location.

The relationship between the NatHERS thermal rating and the Whole of Home performance rating means that increasing thermal performance will increase the Whole of Home performance rating. This is because the heating and cooling energy needs will be lower in a dwelling with a higher thermal star rating.



12. APPLIANCES (WHOLE OF HOME ASSESSMENTS ONLY)

Five key aspects are included in a Whole of Home assessment. These are:

- heating, cooling and hot water – specifying appliances that are more energy efficient will reduce energy use and result in a higher Whole of Home performance rating
- spas and pools – having a pool or spa in a dwelling will reduce the Whole of Home performance rating
- onsite energy production and storage – including onsite energy production and storage systems – will offset energy use, thereby helping to achieve the required Whole of Home performance rating (see also Energy value)
- cooking loads
- plug loads.

12.1.2 Understanding energy value and the Whole of Home performance rating

Assessors should be aware of energy value and its impact on the Whole of Home performance rating.

Energy value¹ is the net cost to society of energy use, including costs to the building user, the environment and impact on energy networks. Energy value also considers the retail cost of the energy used and the greenhouse gas emissions from energy production. Two main factors affect the energy value of any given unit of energy consumed:

- Fuel type – for example, electricity generated for the grid by coal-fired power stations has a higher energy value than electricity generated by a solar photovoltaic (PV) system. Thus, including solar PV in a housing design can reduce the energy value and improve the Whole of Home performance rating.
- Time of use – for example, electricity sourced from the grid during the afternoon (when demand is typically higher) has a higher energy value than electricity consumed at other times. Thus, including battery storage, which shifts the times when energy is drawn from the grid, can reduce the energy value and improve the Whole of Home performance rating.

NatHERS Whole of Home assessments use the energy value of a dwelling to determine its energy performance and assign a rating from 0 to 150. The lower the energy value of the modelled energy loads in the assessment, the higher the Whole of Home performance rating.

Whole of Home software calculates the amount of onsite renewable energy required to achieve a net zero home. A Whole of Home score of 100 equals an energy value of zero and correlates to a net zero home. A rating above 100 means there is a positive impact on the net cost of societal energy use.

Reference (benchmark) dwelling

The Whole of Home performance rating is calculated based on how the assessed dwelling performs compared with a reference or benchmark dwelling (see [Figure 12-1](#)). A score of 50 means that the dwelling design has the same performance as the reference dwelling.

The reference dwelling has the following characteristics:

- 7-star thermal shell
- 3-star ducted heat pump (reverse cycle air conditioning) for heating and cooling (based on the 2019 Greenhouse and Energy Minimum Standards Determination for air-conditioners)
- 5-star instantaneous gas hot water
- lighting power density of 4 watts per square metre (W/m²)
- cooking load – same as the assessed dwelling
- plug load – same as the assessed dwelling
- no spa or pool
- no onsite energy production or storage.

¹ Defined in the [Housing Provisions](#) of the Australian Building Codes Board (ABCB).



12. APPLIANCES (WHOLE OF HOME ASSESSMENTS ONLY)

What the Whole of Home performance rating scale scores mean

The Whole of Home performance rating scale (see Figure 12-2) shows the compliance value (in this case 60 out of 100) at the top of the box, with a bar scale showing how the home has scored and how close it is to being a net zero home.

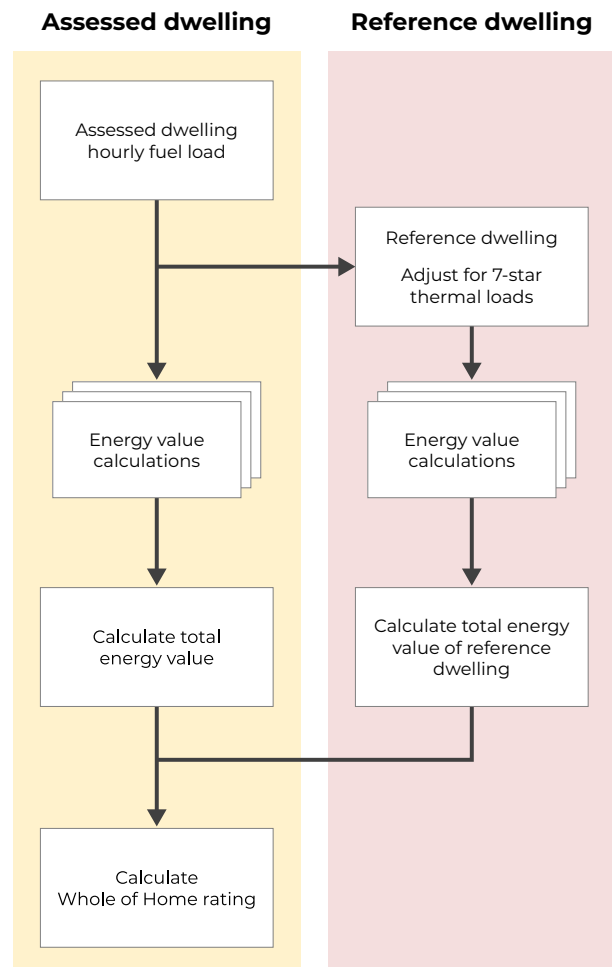

Figure 12-1: How the assessed dwelling performs in comparison with a reference or benchmark dwelling

The Whole of Home rating is on scale of 0 to 150, where:

- 0 is the worst performance rating (there are no negative NatHERS ratings so dwellings that would rate below 0 are given a rating of 0)
- 50 is the score of the benchmark dwelling made up of 100% of regulated loads plus the plug and cooking loads
- 100 is the score of a net zero home (a dwelling with net zero societal cost)
- 150 is the maximum rating awarded under NatHERS although any score above 100 will be displayed at the maximum value of 100.

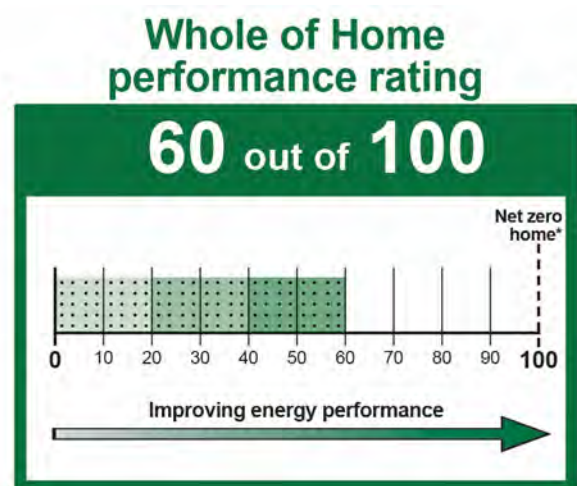

Figure 12-2: Whole of Home performance rating



12. APPLIANCES (WHOLE OF HOME ASSESSMENTS ONLY)

The Whole of Home performance rating requirements under National Construction Code 2022 are shown in [Table 12-1](#). Requirements vary between state and territory jurisdictions.

Table 12-1: National Construction Code 2022 Whole of Home performance rating requirements

ABCB building class	NCC requirements
Class 1	≥ 60/100
Class 2 sole-occupancy units	≥ 50/100
Class 4 part of a building	≥ 50/100
*Benchmark dwelling	= 50/100

12.1.3 NatHERS Technical Note

The assessor should read the [NatHERS Technical Note](#), which contains the requirements that all assessors must follow when conducting a NatHERS assessment.

Note that the guidance in this chapter is nonbinding; it supports but does not replace the use of the current Technical Note. Where there appears to be conflicting information between the current Technical Note and this chapter, the Technical Note takes precedence.

12.1.4 Whole of Home software

Assessors must use NatHERS accredited software to obtain certification of a NatHERS assessment.

The same software tools that are used for thermal energy efficiency assessments are used for assessing compliance with Whole of Home energy efficiency requirements in the National Construction Code (NCC). Refer to the [NatHERS website](#) for current tools and their accreditation status.

All new assessments must be undertaken using the latest version of the chosen software unless an exemption is provided by the relevant building authority. Ensure the software is accredited for a Whole of Home assessment.

12.2 Conducting a NatHERS Whole of Home assessment

The NatHERS Whole of Home assessment builds on the existing NatHERS thermal assessment that is used to verify compliance with the energy efficiency performance requirements of the National Construction Code.

Under National Construction Code 2022 there are two energy efficiency performance requirements for residential buildings: thermal performance and energy usage performance.

A NatHERS assessment verifies compliance with both of the following requirements:

- Thermal assessment and star rating addresses thermal performance.
- Whole of Home performance rating addresses energy usage.

In New South Wales the BASIX tool is used in place of the NatHERS Whole of Home assessment.

A NatHERS Whole of Home assessment is undertaken based on a completed NatHERS thermal assessment. The process for conducting a Whole of Home assessment follows a similar approach to the process for conducting a thermal assessment ([Figure 12-3](#) below).

Assessors should collect the information needed for the assessment before entering data into the assessment software. An assessment can be an iterative process, with adjustments made to inputs to improve energy performance and meet regulatory requirements before it is finalised and the certificate issued.



12. APPLIANCES (WHOLE OF HOME ASSESSMENTS ONLY)

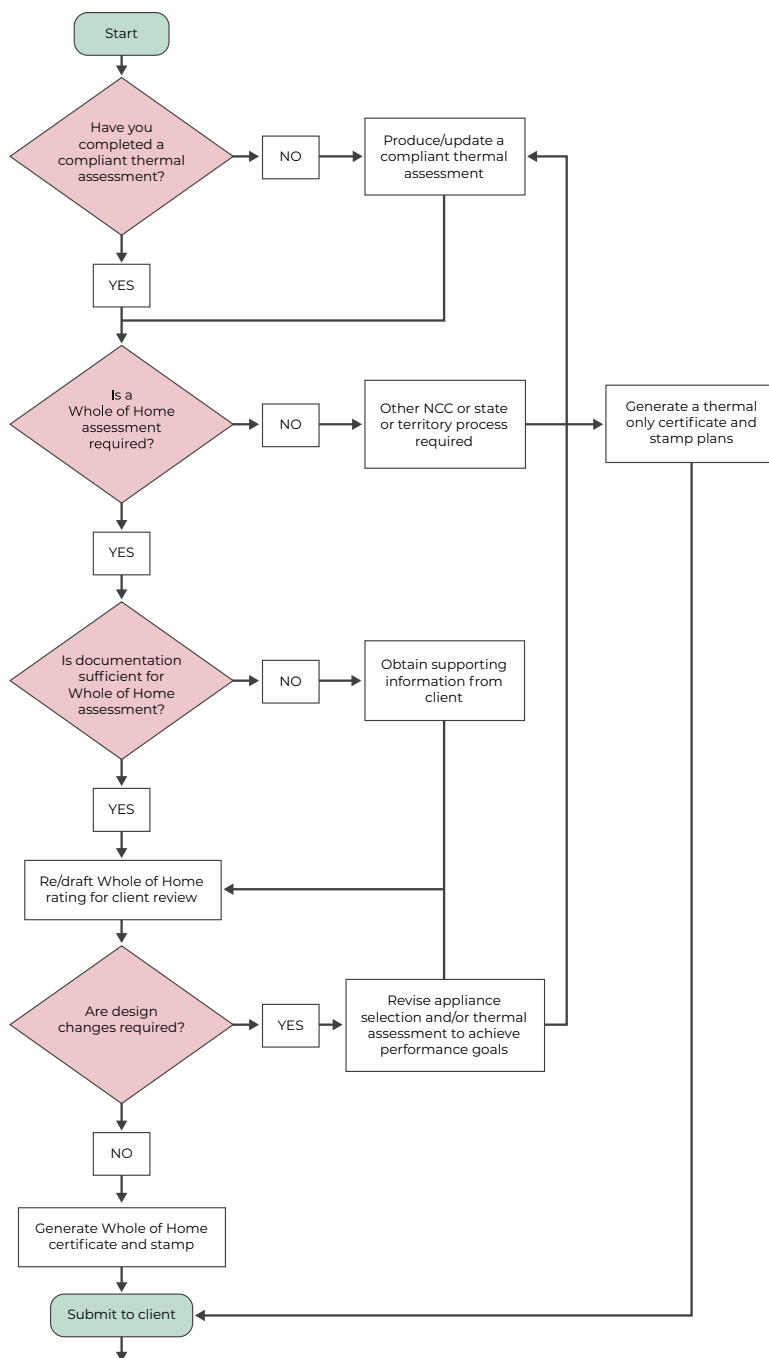

Quality assurance by Accredited Assessor Organisations and regulatory compliance activities with building authorities

Figure 12-3: NatHERS Whole of Home assessment

NCC = National Construction Code

12.2.1 Access a completed NatHERS thermal rating

When beginning a Whole of Home assessment, assessors must ensure that the dwelling has a thermal rating that is compliant in the state or territory in which the dwelling will be constructed. Assessors will also need to ensure that the NatHERS Whole of Home software that they are using is compatible with the NatHERS thermal rating software that was used for the thermal assessment.

Assessors must retain all design, assessment and supporting documentation in line with the relevant jurisdiction's requirements and for auditing and quality assurance.



12. APPLIANCES (WHOLE OF HOME ASSESSMENTS ONLY)

12.2.2 Identify and collect information and documentation

In addition to the documentation requirements for the NatHERS thermal modelling, assessors must collect the information detailed in Sections 12.2.3 to 12.2.10 of this handbook for data input during the Whole of Home assessment. Assessors must retain all design, assessment and supporting documentation in line with the relevant jurisdiction's requirements and for auditing and quality assurance. A checklist for the assessor and client is provided in [Table 12-2](#).

Table 12-2: Checklist – information to collect for Whole of Home rating

Category	Information for rating
Heating and cooling	Appliance type(s) Efficiency rating system (if applicable) Star rating (if applicable) Zone(s) the appliance(s) service
Cooling	Appliance type(s) Efficiency rating system (if applicable) Star rating (if applicable) Zone(s) the appliance(s) service
Hot water	Appliance type Capacity Make and model Efficiency rating system (if applicable) Peak/off peak
Pools and spas	Volume or surface area (to calculate volume) Pump type Star rating
Cooktop	Type Fuel source
Oven	Fuel source
PV	For each array: <ul style="list-style-type: none">• orientation• slope• size (kW) Inverter size PV export limit (if value other than 5kW)
Battery	Type Capacity (kWh)

If the specified type of appliance is not available in the software, assessors must seek guidance from the relevant Assessor Accrediting Organisation or the NatHERS Administrator and include that guidance in the 'additional notes' section of the certificate.

Assessors must enter all data and details accurately, and capture assumptions and other information in the 'additional notes' section.

12.2.3 Heating and cooling appliances – background

Energy efficiency – appliance star ratings

In Australia, air conditioners are regulated under the Greenhouse and Energy Minimum Standards Act 2012 (GEMS Act), which provides a national framework for product energy efficiency.



12. APPLIANCES (WHOLE OF HOME ASSESSMENTS ONLY)

Zoned Energy Rating Label (ZERL)

Since 2019 the Zoned Energy Rating Label (ZERL) provides a seasonal efficiency rating for three distinct climate zones across Australia and New Zealand (hot, average and cold), which helps consumers select a product that best suits their location. Further information can be found on the [Energy Rating website](#) (see [Figure 12-4](#)).

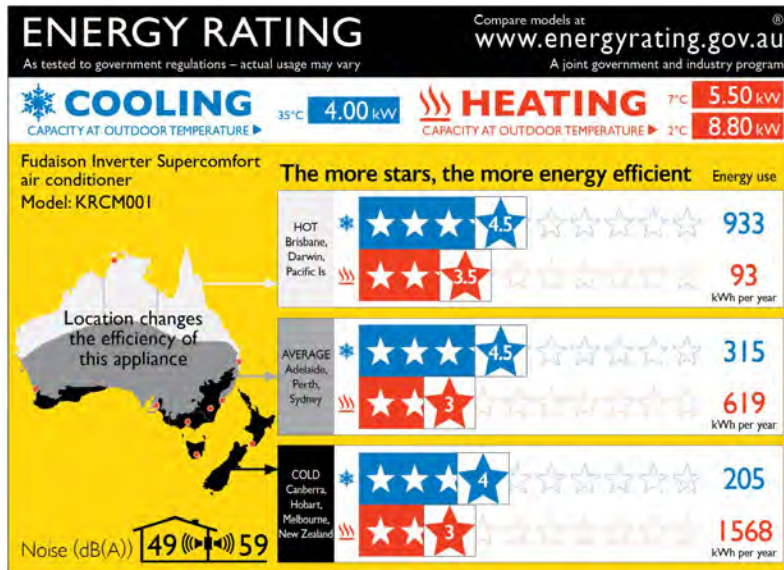

Figure 12-4: ZERL energy rating label

When entering the star rating of a system based on the ZERL rating, assessors should enter the rating applicable to the zone: hot, average or cold, as set out in [Table 12-3](#).

Table 12-3: ZERL energy rating label

NatHERS climate zone	Location name	State/Territory	Applicable GEMS ZERL zone
1	Darwin Airport	NT	Hot/humid
2	Port Hedland Airport	WA	Hot/humid
3	Longreach Aero	Qld	Hot/humid
4	Carnarvon Airport	WA	Hot/humid
5	Townsville Aero	Qld	Hot/humid
6	Alice Springs	NT	Average/Mixed
7	Rockhampton Aero	Qld	Hot/humid
8	Moree MO	NSW	Average/Mixed
9	Amberley Aero	Qld	Average/Mixed
10	Brisbane AMO	Qld	Hot/humid

NatHERS climate zone	Location name	State/Territory	Applicable GEMS ZERL zone
11	Coffs Harbour MO	NSW	Average/Mixed
12	Geraldton Airport	WA	Average/Mixed
13	Perth Airport	WA	Average/Mixed
14	Armidale	NSW	Cold
15	Williamtown AMO	NSW	Average/Mixed
16	Adelaide (Kent Town)	SA	Average/Mixed
17	Sydney RO	NSW	Average/Mixed
18	Nowra RAN	NSW	Cold
19	Charleville AMO	Qld	Average/Mixed



12. APPLIANCES (WHOLE OF HOME ASSESSMENTS ONLY)

NatHERS climate zone	Location name	State/Territory	Applicable GEMS ZERL zone
20	Wagga AMO	NSW	Cold
21	Melbourne RO	Vic	Cold
22	East Sale AMO	Vic	Cold
23	Launceston (Ti Tree Bend)	Tas	Cold
24	Canberra Airport	ACT	Cold
25	Cabramurra	NSW	Cold
26	Hobart RO	Tas	Cold
27	Mildura AMO	Vic	Average/Mixed
28	Richmond	NSW	Average/Mixed
29	Weipa Aero	Qld	Hot/humid
30	Wyndham PO	WA	Hot/humid
31	Willis Island	Qld	Hot/humid
32	Cairns AMO	Qld	Hot/humid
33	Broome Airport	WA	Hot/humid
34	Learmonth Airport	WA	Hot/humid
35	Mackay MO	Qld	Hot/humid
36	Gladstone Radar	Qld	Hot/humid
37	Halls Creek Airport	WA	Hot/humid
38	Tennant Creek	NT	Hot/humid
39	Mount Isa AMO	Qld	Hot/humid
40	Newman	WA	Hot/humid
41	Giles MO	NT	Average/Mixed
42	Meekatharra Airport	WA	Average/Mixed
43	Oodnadatta Airport	SA	Average/Mixed
44	Kalgoorlie	WA	Average/Mixed

NatHERS climate zone	Location name	State/Territory	Applicable GEMS ZERL zone
45	Woomera Aerodrome	SA	Average/Mixed
46	Cobar AMO	NSW	Average/Mixed
47	Bickley	WA	Cold
48	Dubbo Airport	NSW	Cold
49	Katanning	WA	Cold
50	Oakey Aero	Qld	Average/Mixed
51	Forrest AMO	WA	Average/Mixed
52	Swanbourne	WA	Average/Mixed
53	Ceduna	SA	Average/Mixed
54	Mandurah	WA	Average/Mixed
55	Esperance	WA	Cold
56	Mascot AMO	NSW	Average/Mixed
57	Manjimup	WA	Cold
58	Albany Airport	WA	Cold
59	Mount Lofty	SA	Cold
60	Tullamarine	Vic	Cold
61	Mount Gambier AMO	SA	Cold
62	Moorabbin Airport	Vic	Cold
63	Warrnambool	Vic	Cold
64	Cape Otway	Vic	Cold
65	Orange AP	NSW	Cold
66	Ballarat Aerodrome	Vic	Cold
67	Low Head	Tas	Cold
68	Launceston AP	Tas	Cold
69	Thredbo Valley	NSW	Cold



12. APPLIANCES (WHOLE OF HOME ASSESSMENTS ONLY)

Older registrations

Current models for sale may have older registrations. They can continue to use the old Energy Rating Label (Figure 12-5) until their registration expires in 2025. Once these registrations expire and the products are re-registered, they will need to display the Zoned Energy Rating Label.

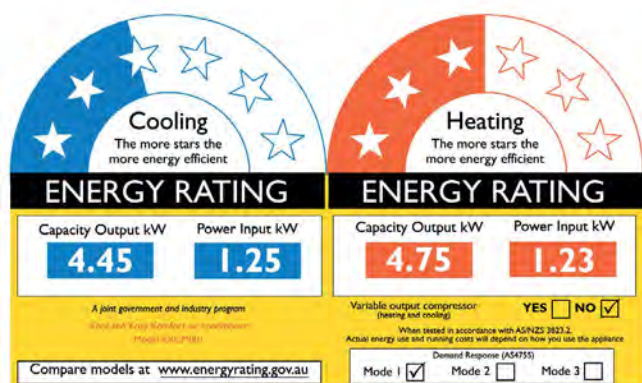

Figure 12-5: Old energy rating label

The heating and cooling appliance types available for selection in NatHERS Whole of Home software are set out in Table 12-4.

Table 12-4: Heating and cooling appliance types and ratings

Function	Ducted/non-ducted	Appliance type	Energy rating system
Heating and cooling	Non-ducted – fixed	Reverse cycle air conditioner	2013 or ZERL star rating
Heating and cooling	Non-ducted – variable	Reverse cycle air conditioner	2013 or ZERL star rating
Heating and cooling	Ducted – fixed	Reverse cycle air conditioner	2013 or ZERL star rating
Heating and cooling	Ducted – variable	Reverse cycle air conditioner	2013 or ZERL star rating
Heating only	Non-ducted	Gas heater	Industry star rating
Heating only	Ducted	Gas heater	Industry star rating
Heating only	Non-ducted	Electric resistance heater	n/a
Heating only	Non-ducted	Wood heater	n/a
Heating only	To be determined	Hydronic heating – this feature is currently not available in NatHERS	n/a
Heating only	To be determined	In slab heating – this feature is currently not available in NatHERS	n/a
Cooling only	Non-ducted	Evaporative	n/a
Cooling only	Ducted	Evaporative	n/a
Cooling only	Non-ducted – fixed	Space chiller	2013 or ZERL star rating
Cooling only	Non-ducted – variable	Space chiller	2013 or ZERL star rating
Cooling only	Ducted – fixed	Space chiller	2013 or ZERL star rating
Cooling only	Ducted – variable	Space chiller	2013 or ZERL star rating



12. APPLIANCES (WHOLE OF HOME ASSESSMENTS ONLY)

Air conditioners for heating and cooling (heat pumps, reverse cycle)

Systems which have a fixed capacity include all systems with a single-speed compressor or a two-speed compressor, classified as a fixed-capacity unit or two-stage-capacity unit under AS/NZS3823.4.1. Variable capacity includes multistage-capacity units and variable-capacity units (usually inverter driven) under AS/NZS3823.4.1.

Evaporative coolers

Evaporative systems are most suited to hotter and drier climates. Specifically, evaporative coolers are most suitable for climates with a high-to-moderate cooling load and where the relative humidity is lower. Refer to [Table 12-5](#) to ascertain the suitability of an evaporative cooler in a specific climate.

Table 12-5: Evaporative cooler suitability in different climate zones

NatHERS climate zone	Location name	State/Territory	Evaporative cooler suitability
1	Darwin Airport	NT	Not suitable
2	Port Hedland Airport	WA	Not suitable
3	Longreach Aero	Qld	Marginal
4	Carnarvon Airport	WA	Not suitable
5	Townsville Aero	Qld	Not suitable
6	Alice Springs	NT	Suitable
7	Rockhampton Aero	Qld	Not suitable
8	Moree MO	NSW	Suitable
9	Amberley Aero	Qld	Not suitable
10	Brisbane AMO	Qld	Not suitable
11	Coffs Harbour MO	NSW	Not suitable
12	Geraldton Airport	WA	Marginal
13	Perth Airport	WA	Suitable
14	Armidale	NSW	Low cooling
15	Williamtown AMO	NSW	Not suitable
16	Adelaide (Kent Town)	SA	Suitable
17	Sydney RO	NSW	Not suitable
18	Nowra RAN	NSW	Marginal
19	Charleville AMO	Qld	Suitable
20	Wagga AMO	NSW	Suitable
21	Melbourne RO	Vic	Suitable
22	East Sale AMO	Vic	Marginal
23	Launceston (Ti Tree Bend)	Tas	Low cooling
24	Canberra Airport	ACT	Suitable
25	Cabramurra	NSW	Low cooling
26	Hobart RO	Tas	Low cooling
27	Mildura AMO	Vic	Suitable
28	Richmond	NSW	Marginal
29	Weipa Aero	Qld	Not suitable
30	Wyndham PO	WA	Not suitable
31	Willis Island	Qld	Not suitable
32	Cairns AMO	Qld	Not suitable
33	Broome Airport	WA	Not suitable
34	Learmonth Airport	WA	Marginal
35	Mackay MO	Qld	Not suitable
36	Gladstone Radar	Qld	Not suitable
37	Halls Creek Airport	WA	Marginal
38	Tennant Creek	NT	Marginal
39	Mount Isa AMO	Qld	Marginal
40	Newman	WA	Suitable
41	Giles MO	NT	Suitable
42	Meekatharra Airport	WA	Suitable



12. APPLIANCES (WHOLE OF HOME ASSESSMENTS ONLY)

NatHERS climate zone	Location name	State/Territory	Evaporative cooler suitability
43	Oodnadatta Airport	SA	Suitable
44	Kalgoorlie	WA	Suitable
45	Woomera Aerodrome	SA	Suitable
46	Cobar AMO	NSW	Suitable
47	Bickley	WA	Suitable
48	Dubbo Airport	NSW	Suitable
49	Katanning	WA	Suitable
50	Oakey Aero	Qld	Marginal
51	Forrest AMO	WA	Suitable
52	Swanbourne	WA	Marginal
53	Ceduna	SA	Suitable
54	Mandurah	WA	Marginal
55	Esperance	WA	Suitable
56	Mascot AMO	NSW	Not suitable

NatHERS climate zone	Location name	State/Territory	Evaporative cooler suitability
57	Manjimup	WA	Suitable
58	Albany Airport	WA	Low cooling
59	Mount Lofty	SA	Low cooling
60	Tullamarine	Vic	Suitable
61	Mount Gambier AMO	SA	Suitable
62	Moorabbin Airport	Vic	Suitable
63	Warrnambool	Vic	Low cooling
64	Cape Otway	Vic	Low cooling
65	Orange AP	NSW	Low cooling
66	Ballarat Aerodrome	Vic	Suitable
67	Low Head	Tas	Low cooling
68	Launceston AP	Tas	Low cooling
69	Thredbo Valley	NSW	Low cooling

12.2.4 Heating and cooling appliances – modelling

- 12a** Assessors must model the main and any additional heating and cooling appliance type for each NatHERS designated conditioned zone as shown on the design documentation. If not specified, the default appliance type and performance levels/star ratings in the NatHERS Technical Note must be selected.
- 12b** If the tool allows only one appliance per zone to be entered, assessors must use the main heating and cooling appliance in the zone.
- 12c** If the tool flags that the entered efficiency is higher than what is known to be available in the Australian market, the assessor must notify the designer and update the efficiency in the assessment to reflect the documentation.
- 12d** If no appliance is specified, the default heating or cooling appliance shown in the NatHERS Technical Note is applied to conditioned zones.
- 12e** In the case of a ducted system, assessors must define all zones it services.

Assessors must assign heating and cooling appliances to each conditioned zone as per these instructions:

- If a heating and cooling appliance is not specified, assessors must use the default value shown in the NatHERS Technical Note or [Table 12-7](#). (**Tech Note clause 12.1**)
- If appliance details are specified, assessors must enter the type and efficiency of the appliance as shown on design documentation.
- Where more than one heating or cooling appliance type is specified for a conditioned zone, assessors must enter both.
- If a ducted system is documented as supplying several zones, assessors must apply the heating or cooling appliance type to **all** zones serviced by the ducted system.



12. APPLIANCES (WHOLE OF HOME ASSESSMENTS ONLY)

- Where design documentation is not specific about a heating or cooling appliance in a particular zone, two or more adjacent spaces may be considered to be served by the same space heating and cooling equipment provided that the spaces are either:
 - kitchen/living/daytime zones only
or
 - bedroom/night-time zones only

This means that two adjacent spaces – where one is a daytime zone and one is a night-time zone – cannot be served by the same space heating or cooling equipment except where:

- the spaces are connected by a door or an opening, and
 - total floor area of the space/s without space conditioning installed is not more than 30% of the floor area of the space where the space conditioning is installed, or there is evidence that the appliance was sized specifically to condition all spaces.
- Multi-split systems that service multiple zones must be modelled as individual non-ducted heat pump units in each serviced zone.
 - If appliance type, efficiency and location are not available, assessors must use the default values shown in the NatHERS Technical Note or [Table 12-7](#) below. (**Tech Note clause 12.1**)

Exclusions:

At the time of releasing this version of the Assessor Handbook, no calculation methods exist in NatHERS for the following:

1. Centralised space conditioning services for apartments cannot be specified in NatHERS.
2. Hydronic heating – a calculation method will be developed for future implementation.
3. In-slab heating – a calculation method will be developed for future implementation.

Refer to the NatHERS website for updates on calculation methods for these systems.

12.2.5 Hot water system – background

Energy efficiency – small-scale technology certificates

Small-scale technology certificates (STCs) represent a financial incentive for the installation of solar and heat pump hot water systems. The Clean Energy Regulator (CER) is a non-corporate Commonwealth entity which awards solar-boosted and heat pump hot water systems with STCs under the Small-scale Renewable Energy Scheme (SRES).

The SRES is designed to create renewable energy over a period of 10 years, known as the deeming period and certificates are awarded across that period. However the SRES is winding down and will finish at the end of 2030 so the deeming period for awarding STCs is reducing. Since there are fewer than 10 years left in the scheme, NatHERS software discounts STCs to account for this.



12. APPLIANCES (WHOLE OF HOME ASSESSMENTS ONLY)

As there are currently no star rating systems for heat pump and solar hot water heaters, STCs – which are calculated based on efficiency and size of a system – are used in NatHERS Whole of Home as a proxy for energy efficiency. As such, we ignore the deeming period left in the scheme and require the assessor to enter the 10-year STC for the system. This is obtained in one of two ways:

1. The CER maintains a register of solar water heaters that are eligible² for STCs (the register provides the 10-year STC for the system). This can be entered by the assessor without accounting for any reduction in the deeming period. Assessors must use the STC for the CER zone in which the dwelling is to be built.
or
2. The Renewable Energy Certificates (REC) Registry has a calculator³ for how many certificates a system is eligible for, based on its installation date. Assessors must use the STC for the CER zone in which the dwelling is to be built. The calculator uses the number of years remaining to 2030. As such, the assessor will need to convert the number from the calculator back to a 10-year STC, using the following formula:

$$STC \text{ Equivalent} = \frac{STCs \text{ Awarded}}{2031 - \text{Installation Year}} \times 10$$

Where:

STC Equivalent = the number of STCs assumed to be awarded by the system for a 10-year deeming period, rounded up to the next whole number.

STCs Awarded = Number of STCs awarded by the REC Registry calculator.

12.2.6 Hot water system – modelling

Hot water system

- 12f** Assessors must enter the hot water system specified by the design documentation. If no hot water system is specified, assessors must select the appropriate default value shown in the NatHERS Technical Note.
- 12g** Reassessment of the Whole of Home performance rating is required after the initial assessment for the following reasons: solar thermal boost fuel change, hot water technology change, reduction in STCs.

For hot water system modelling assessors must enter the details as follows:

- Hot water service type (ideally including model and size).
- Appliance efficiency (with metric appropriate to the appliance type).

If this information is not available, use the default value shown in the NatHERS Technical Note or [Table 12-7](#) below. (**Tech Note clauses 12.8 – 12.9**)

Exclusion: Apartment centralised hot water services cannot be specified in NatHERS at the time of releasing this version of the Assessor Handbook. Refer to the NatHERS website for updates on when this may be included. The calculation method for centralised applications is being developed for future iterations of NatHERS Whole of Home.

² [Register of solar water heaters \(cleanenergyregulator.gov.au\)](http://cleanenergyregulator.gov.au)

³ [REC Registry - Solar water heater STC calculator \(rec-registry.gov.au\)](http://rec-registry.gov.au)



12. APPLIANCES (WHOLE OF HOME ASSESSMENTS ONLY)

Solar photo voltaic diverters

Solar photo voltaic diverters (PVDs) divert surplus energy from a solar power system to a hot water system. There are three types of diverters:

- Type 1: Simple timer. These systems are standard electric storage hot water systems with a timer installed so that they heat water during the day rather than overnight.
- Type 2: Modulated input into an existing storage tank – add-on product. This type of system has a retrofitted external control added to an existing standard electric storage hot water system. The controller monitors the house load and local PV generation and diverts any excess local PV generation to the water heater where possible.
- Type 3: Bespoke PV diverter – dedicated product. This is a specially designed PV solar diverter hot water system. The controller is able to monitor the house load and local PV generation and diverts excess solar energy to the water heater.

If a solar PV diverter for a water heater is modelled, evidence of the energisation profile for the diverter type must be provided or the assessor must model an electric storage hot water system. (**Tech Note clause 12.10**)

Table 12-6 lists the STC treatment for relevant appliances.

Table 12-6: Hot water systems in NatHERS Whole of Home

Appliance	Size / type	Rating
Heat pump	n/a	10-year STC
Solar thermal – electric boosted	n/a	10-year STC
Solar thermal – gas boosted	n/a	10-year STC
Gas storage	n/a	Star rating
Gas instantaneous	n/a	Star rating
Electric storage – off peak ⁴	Off peak (labelled as “Large” in some tools)	No efficiency input required
Electric storage – continuous ⁵	Continuous (labelled as “Small”)	No efficiency input required
Solid-fuel heater	n/a	No efficiency input required, unless there are grounds for a different efficiency performance
Solar PV diverter water heater Type 1: Simple timer	n/a	Type 1
Solar PV diverter water heater Type 2: Modulated input into existing storage tank	n/a	Type 2
Solar PV diverter water heater Type 3: Bespoke PV diverter	n/a	Type 3

⁴ Where the electric storage unit is designed for off-peak use, enter “large” regardless of the litre capacity

⁵ Where the electric storage unit is designed for continuous use, enter “small”, regardless of the litre capacity



12. APPLIANCES (WHOLE OF HOME ASSESSMENTS ONLY)

12.2.7 Pool and spa pumps – background

If spas and pools are shown on the documentation, they must be included in the Whole of Home assessment. The energy calculation will consider the energy use of pumps. Heating for pools and spas is not included in the Whole of Home energy calculations.

12.2.8 Pool and spa pumps – modelling

12h If a pool and/or spa are present in the design documentation, assessors must enter the volume or surface area (to calculate the volume), pump type and star rating. If the pump type or pump star rating are unknown, assessors must enter default values.

For spa and pool volume, assessors must enter the details as follows:

- Enter the volume. If pool volume is not known, estimate it based on the surface area.

$$\text{Volume (L)} = \text{surface area (m}^2\text{)} \times \text{depth (1.5m)} \times 1000$$

If the software does not include a function to calculate the volume, the assessor must use this formula to calculate it manually.

For pool pumping enter the details as follows:

- If pool pumping information is included in the documentation, assessors must enter the equipment type (e.g. single-, dual- or multi-speed pump). If pool pumping and cleaning equipment information is not specified, assessors must apply default values as shown in the NatHERS Technical Note or [Table 12-7](#). (**Tech Note clauses 12.1 and 12.15**)
- If the software tool has the functionality to allow pump star ratings to be entered then the assessor may do so. If the assessor does not do so, the back end of the software will apply the default values set out in [Table 12-7](#). (**Tech Note clauses 12.1 and 12.15**)

12.2.9 Onsite renewable energy – background

12i Only solar photovoltaic (PV) renewable energy systems are included in Whole of Home calculations. Assessors must enter the array size, inclination, direction and inverter capacity as provided in the design documentation. Where system values are unknown, apply the defaults provided in the NatHERS Technical Note.

12j NatHERS cannot specify centralised PV systems for Class 2 buildings or Class 4 parts of a building.

Incorporating renewable energy generation in the NatHERS Whole of Home assessment allows households to offset their modelled energy use. In many cases, onsite renewable energy may be needed for a project to pass the Whole of Home performance rating requirement. Or, if the target rating is more ambitious, onsite renewable energy can be used to improve a dwelling towards a net zero home.

Renewable energy in the NatHERS Whole of Home assessment is limited to solar PV systems.

The available solar radiation at the location of the dwelling is assigned based on climate zone. The Whole of Home software calculates the hourly available electrical supply from a PV installation for the whole year. This calculation takes into consideration the:

- location and climatic conditions
- slope and orientation of the PV panels
- rated output of the arrays
- inverter size of the system
- export capacity of the system.

Note: Shading of PV systems is not currently included. (**Tech Note clauses 12.17 – 12.19**)



12. APPLIANCES (WHOLE OF HOME ASSESSMENTS ONLY)

12.2.10 Onsite renewable energy – modelling

- Assessors must enter the details for both the system and the panels. Each separate array (groups of panels with a different orientation and/or slope) must be entered individually into the Whole of Home software.

The system details to be entered are:

- the rated PV system size (kW; number of panels × watts per panel/1,000)
- PV array azimuth (orientation) – if panels are oriented due north, enter the azimuth as 0° or 360°. Orientation must be relative to true north, not magnetic north. See [Chapter 4](#) and [Chapter 14 Definitions](#).
- PV array slope or inclination (the panels' angle above horizontal) – angle between 0° and 90°
- the capacity of the specified inverter (kW) and number of phases (single-, two- or three-phase)
- the PV energy export set at a default of 5 kW per phase because this is the limit in most jurisdictions around Australia (alternative values in an assessment must provide evidence to support a higher limit)
- if a PV diverter for hot water is specified, enter the relevant details as part of the hot water module (see [Section 12.2.6](#) in this chapter).

The size of the PV system must be known; otherwise it cannot be included as there are no default values for a PV system. Where other values are unknown, apply the defaults provided in [Table 12-7](#). These must be noted in the 'additional notes' field of the NatHERS Certificate. (**Tech Note clause 12.17**).

Exclusion: centralised PV systems for Class 2 buildings or Class 4 parts of a building cannot be specified in NatHERS.

12.2.11 Onsite energy storage (batteries) – background

Where the output from solar PV exceeds the hourly demand for electricity in any given hour, a battery may be used to store that excess generation for use at a later time (e.g. at night).

Installing a battery system can significantly improve performance on the Whole of Home performance rating, because it allows the household to retain and use a greater proportion of the electricity generated onsite. This reduces the need to import from the grid during shoulder and peak times. Since the energy value of imports is higher than that of exports, reducing imports is more effective than increasing exports for improving the performance rating.

12.2.12 Onsite energy storage (batteries) – modelling

12k Assessors must enter the battery technology type and size provided in the design documentation. Currently only lithium-ion, lead-acid and zinc-bromine battery types can be entered.

Two parameters are required for NatHERS Whole of Home software to calculate the impact of the battery storage system on the energy calculations. If an onsite storage system is specified in the documentation, assessors must enter the:

- battery technology type – battery type choices are lithium-ion, lead-acid and zinc-bromine (other battery types may be added in future) (**Tech Note clause 12.21**)
- battery nominal storage capacity (kWh).

To maintain consistency in ratings, default values based on battery technology type must be used for all other characteristics. These characteristics are:



12. APPLIANCES (WHOLE OF HOME ASSESSMENTS ONLY)

- maximum depth of discharge
- charge efficiency
- discharge efficiency
- battery charge rate
- round-trip efficiency
- assumed initial battery charge.

If more detailed information about onsite battery characteristics is available, assessors may enter this if there is documentation to justify it and the software tool has the functionality. Otherwise, the default values must be used.

12.2.13 Lighting – background and modelling

12i Assessors must enter the lighting power density in the design documentation. If unknown, apply the default value of 5W/m².

The values assessors enter for lighting will depend on the available information and the capabilities of the Whole of Home assessment software.

If the software allows this input and lighting specifications are provided, assessors must calculate the lighting density for the whole home using the ABCB [lighting calculator](#) and must enter this calculated lighting density value into the software (W/m²).

If the software does not allow this input or if assessors do not have the lighting specifications they must apply the default lighting density of 5W/m². (**Tech Note clause 12.14**)

12.2.14 Cooking appliances – background and modelling

12m Assessors must enter the energy source(s) of cooking appliances. If the energy source(s) are unknown, defaults must be modelled and noted in the 'additional notes' field of the certificate.

The Whole of Home software estimates the energy used by cooking in the Whole of Home assessment based on energy source and occupancy.

Assessors must enter the energy source of the cooking appliances. The options are gas, electricity or induction for cooktops and gas or electricity for ovens.

If energy source(s) for cooking appliances are not specified, assessors must refer to the default energy source(s) in the NatHERS Technical Note or [Table 12-7](#). (**Tech Note clauses 12.1 and 12.12 – 12.13**)

12.2.15 Plug-loads – background and modelling

Assessors are not required to enter any information about plug-loads. However, assessors should be aware that the estimated electricity used by plug-in appliances will affect the overall energy use of the home and the Whole of Home rating.

The Whole of Home software estimates the energy used by plug-in appliances in the Whole of Home assessment, based on the number of occupants for the dwelling. The plug-load covers all electrical equipment, apart from appliances noted in other sections of the assessment. It includes items such as whitegoods, audio visual equipment, small appliances, computers and peripherals, other electronics, standby power and plug-in electric cooking equipment, such as microwave ovens.

Being aware of the plug-load is particularly important in relation to solar PV generation (see [Section 12.2.10](#)). These loads can consume a considerable amount of electricity, which will be reflected in the calculation done by the software.



12. APPLIANCES (WHOLE OF HOME ASSESSMENTS ONLY)

12.2.16 Default values

If any of the information required to perform a Whole of Home assessment is not provided, assessors must use the default values in [Table 12-7](#) below and in the Tech Note. (**Tech Note clause 12.1**). Default values are updated from time to time and the most up-to-date information will be in the Tech Note. Assessors should encourage their clients to provide accurate information and advise them that defaults often represent the worst-case scenario and the rating may be adversely affected. Any defaults used for the assessment must be detailed in the NatHERS Certificate 'additional notes'.

Table 12-7: Default values for appliances

Appliance or system	Technology	Performance level/rating
Heating in cold ^a climate	Room reverse cycle air conditioner	HSPF: 2.5 Star rating: 1.0 ^d
Heating in mixed/average ^b climate	Room reverse cycle air conditioner	HSPF: 3.5 Star rating: 2.0 ^d
Heating in hot ^c and humid climate	Room reverse cycle air conditioner	HSPF: 4.0 Star rating: 2.5 ^d
Cooling in cold ^a climate	Room reverse cycle air conditioner	TCSPF: 3.5 Star rating: 2.0 ^d
Cooling in mixed/average ^b climate	Room reverse cycle air conditioner	TCSPF: 3.5 Star rating: 2.0 ^d
Cooling in hot ^c and humid climate	Room reverse cycle air conditioner	TCSPF: 4.0 Star rating: 2.0 ^d
Wood heater	Slow combustion	60%
Hot water	Choose one of two options: Gas storage system where reticulated gas is available at the dwelling (i.e. at least one gas appliance has been specified in the dwelling)	Star rating: 4.0
	OR Electric storage hot water system – off peak, where reticulated gas is not available at the dwelling (i.e. no gas appliances have been specified for the dwelling)	Performance not entered by assessor
Lighting	5 W/m ²	
Cooktops	Choose one of two options: Gas where reticulated gas is available at the dwelling (i.e. at least one gas appliance has been specified in the dwelling)	Performance not entered by assessor
	OR Electric where reticulated gas is not available at the dwelling (i.e. no other gas appliances have been specified for the dwelling)	Performance not entered by assessor
Ovens	Electric	Performance not entered by assessor
Pools and spas	System cannot be included in rating if not specified in design documentation	n/a



12. APPLIANCES (WHOLE OF HOME ASSESSMENTS ONLY)

Appliance or system	Technology	Performance level/rating
Pools and pumps star ratings	Single speed: Dual speed: Multi-speed/variable:	1 star 3 stars 5 stars
Solar PV	System cannot be included in rating if not specified in design documentation	n/a
Solar PV inclination (slope)		Same as documented roof pitch where array will be installed
Solar PV direction (azimuth)		Same as documented roof direction where the array will be installed
Solar PV inverter capacity		Total system size (kW) x 0.75

- Cold climates zones:
14, 18, 20, 21, 22, 23, 24, 25, 26, 47, 48, 49, 55, 57, 58, 59, 60, 61, 62, 63, 64, 65, 66, 67, 68, 69
- Mixed/average climate zones:
6, 8, 9, 11, 12, 13, 15, 16, 17, 19, 27, 28, 41, 42, 43, 44, 45, 46, 50, 51, 52, 53, 54, 56
- Hot/humid climate zones:
1, 2, 3, 4, 5, 7, 10, 29, 30, 31, 32, 33, 34, 35, 36, 37, 38, 39, 40
- Star ratings and performance levels rated under 2019 GEMS determination

12.2.17 Final processes

Once all data inputs have been entered, assessors can finalise the assessment.

Run the Whole of Home calculation

When inputs have been completed, the Whole of Home energy calculation can be run.

If the Whole of Home performance rating complies with the regulatory requirements, assessors may move to the next step.

If the Whole of Home performance rating does not comply, then further discussion may be required with the designer or client on how to achieve compliance or optimise the design towards net zero ([Figure 12-3: NatHERS Whole of Home assessment](#)). Begin again by returning to [Section 12.2.2](#) in this chapter and adjust the specifications and inputs as necessary, in consultation with the designer and client.

Where possible, assessors should encourage clients to optimise the design beyond minimum compliance towards net zero.

Generate the NatHERS certificate and stamp (mini certificate)

Once a complying Whole of Home performance rating is achieved and the documentation is finalised, assessors can generate the NatHERS certificate and stamp (mini certificate), using NatHERS software in conjunction with an online certification portal. Assessors should refer to the relevant software tool manual on how to generate the certificates.

Stamp drawings and provide to client with the NatHERS certificate

Assessors must follow the AAO and NatHERS requirements to stamp documentation for building approval purposes. See [Chapter 13 Finalising the assessment](#).



12.3 Whole of Home NatHERS Certificate

The updated NatHERS certificate with the Whole of Home assessment includes details of the property, the Whole of Home performance rating, heating and cooling load limits, and the impact of appliances.

The certificate has multiple pages including a checklist, schedules of selections used in both the thermal and Whole of Home assessments, explanatory notes and a glossary.

Assessors can view a [sample certificate](#) and a [guide showing changes from NCC 2019](#) on the NatHERS website.

12.4 How to improve a rating

A Whole of Home assessment can be an iterative process requiring an assessor to investigate different combinations to improve energy performance. This means making adjustments to inputs before a rating is finalised and the certificate issued.

Below are options to trial as a means of improving a rating. The list is not exhaustive and as assessors become familiar with Whole of Home assessments they may develop their own list of optimisations:

- Improve the thermal rating of the project. This will reduce the overall need for heating and/or cooling which in turn improves the Whole of Home rating.
- Select higher efficiency appliances and size appropriately.
- Change appliance type; e.g. change ducted air conditioning to room reverse cycle air conditioning which is generally considered more efficient as there are no losses associated with the ducts and the systems can be more accurately sized for individual zones.
- Switch between fuel technologies; e.g. from a gas instantaneous hot water heater to a solar electric hot water heater.
- Install load shifting technologies to reduce energy demand during peak hours; e.g. install a battery, orient some PV panels to the west to generate energy during the afternoon and evening peaks, run a heat pump hot water system off-peak (depending on solar PV this may or may not be advantageous).
- Add onsite renewable energy (PV).
- Speak to the client about reducing the size of the home as many Whole of Home calculations are based on floor area (m²).
- Since the energy value of imports is higher than that of exports, reducing imports is more effective than increasing exports for improving the performance rating.



12.5 When to re-simulate the NatHERS Whole of Home assessment

If project specifications change, the Whole of Home assessment must be revised. Examples of revisions which require a re-rating and a new certificate issued, include:

- an updated NatHERS thermal assessment
- a change in the technology type for any of the appliance categories; e.g.:
 - room reverse cycle air conditioner replaced with ducted reverse cycle air conditioner
 - gas instantaneous hot water heater replaced with gas storage
 - gas cooking appliance replaced with electric cooking appliance
 - lithium-ion battery replaced with lead-acid battery
 - variable pool pump replaced with single-speed pool pump
- a reduction in appliance efficiency; e.g.:
 - 6-star gas heater replaced with 5-star gas heater

(If an appliance or technology is replaced by a higher-efficiency version of the same technology (e.g. a 6-star hot water system replaces a 5-star hot water system), it is not necessary to re-simulate the assessment but a better rating may be achieved)

- decreased hot water system small-scale technology certificates (STC), specifically if the STC value is below the substitution range noted in the certificate

Note that a change in the number of STCs can result from either a change to the specified heater or a change to the specified heater size.

- a reduced PV system size and/or change in orientation and slope
- an increased pool or spa volume.



13

Finalising the assessment



IN THIS CHAPTER

13.1	Interpreting results	163
13.2	Improving a rating	164
13.3	Tips to achieving the rating goal	166
13.4	Certification	167





There are various stages to finalising a NatHERS assessment including interpreting and adjusting the results (if necessary) and producing a certificate and stamping the documentation.

Summary of key requirements

This handbook is intended to be a helpful resource for all assessors. When conducting assessments, assessors must follow the requirements of the current NatHERS Technical Note and the relevant state or territory requirements.

- 13a** Assessors must ensure that any recommendations are agreed to by the client and any amendments are included in the final drawing set and documentation.
- 13b** Assessors must ensure that all the information used in the rating is on the final set of approved drawings. This detail may be documented by the architect or building designer as:
 - graphical representations (standard industry drawing of wall types, material types, etc)
 - notations either in a list or throughout the drawing set.
- 13c** For Class 2 buildings, each individual dwelling or unit must have an individual NatHERS certificate and the entire building must have a NatHERS summary certificate.
- 13d** At the request of a client, a single Class 2 summary certificate can be produced for buildings that are combined and share a lot (for example, by a bridge, shared underground space or an enclosed walkway), where NCC requirements for combined buildings are met.
- 13e** Before stamping drawing sets with the NatHERS QR code stamp or issuing a NatHERS certificate, assessors must confirm all requirements detailed in the NatHERS Technical Note have been met and that the information in the assessment aligns with the design documentation.
- 13f** If any details are not present on the drawings, or differ from the rating assessment, the assessor must return the drawing set to the client or author of the drawings for the information to be added and new drawing versions issued.
- 13g** The NatHERS QR code stamp must be added electronically to all design documentation that is relevant to the NatHERS assessment. As a minimum this includes but is not limited to:
 - site and floor plans
 - elevations and sections
 - materials documentation
 - window, skylight and door schedules
 - shadow drawings
 - electrical plans including lighting and mechanical ventilation
 - insulation information (e.g. contained within construction drawings) where provided

13. FINALISING THE ASSESSMENT

- appliance schedule
- any design amendments
- supporting reports.

The stamp should not obscure any information on the design documentation or the mark of any other practitioner.

13h Assessors must follow directions from their AAO and include their AAO stamp when required.

13i For Class 2 dwellings, the NatHERS Class 2 summary QR code stamp is to be stamped on each page of the documentation that is relevant to the NatHERS assessment.

13.1 Interpreting results

Once an assessment has been completed, it is important to interpret the results. For example, this may be to adjust the design to meet the particular rating goal (see [Section 2.5](#)) or to assess existing conditions with the intent to upgrade recommendations.

There are three main outputs produced by NatHERS software tools. These are:

- star rating
- adjusted annual heating load (MJ/m²)
- adjusted annual cooling load (MJ/m²).

Although the star rating indicates compliance and the rating goal if required, the heating and cooling loads hold the information needed to interpret and adjust the star rating results.

Interpreting the results has two main steps:

- Determining if the results are correct: Assessors should consider whether the results are consistent with what would be expected based on the dwelling design, climate, orientation, materials, glazing, insulation and other factors.

In a cold climate, the heating load should be greater than the cooling load, as dwellings in colder areas are usually focused on keeping warm in winter. The use of heaters to maintain comfort is expected.

In a warm climate, the cooling load should be higher than the heating load, as dwellings in warmer areas are usually focused on keeping cool in summer (and sometimes winter). The use of artificial cooling such as air-conditioning is expected.

In some locations, where the climate is mild, the loads should almost be equal.

- Checking data: If the results are not what should be expected, it is important to ensure the data entered is accurate and consistent with the documentation.

Once the data entry and assessment have been reviewed and are correct, assessors need to decide in collaboration with the client whether the results are within the parameters of the relevant compliance requirements or rating goal and whether adjustment of the design is needed.

If the assessor and the client decide an adjustment is needed, the steps in the following section should be followed. Some general information about thermal performance is provided in [Chapter 2](#).



13.2 Improving a rating

There are a series of steps to follow to adjust the rating results.

When considering these steps, assessors should remember that any adjustment should still take into account the following:

- Regulatory requirements – adjustments should be made within state or territory jurisdictional requirements and compliance, and within the application of the National Construction Code.
- Liveability – adjustments should not be made if they will unreasonably reduce comfort or amenity for the occupants. For example, suggesting an unreasonable reduction in window size or placement, or reducing ceiling heights to an uncomfortable level.
- Feasibility (can be built, is cost effective, etc.) – adjustments should be feasible or the design fully adjusted to make them feasible. For example, specifying higher insulation thickness without adjusting wall cavity thickness will not be possible, or recommending products that cannot be installed or are unsuitable for the use suggested could lead to legal action.

13.2.1 Step 1: Review the heating and cooling loads of the initial rating

The first step to improve a rating is to review the heating and cooling loads from the rating, to identify whether it is the heating or cooling load (or a combination of both) that is driving the star rating result.

- If the heating load is much higher than the cooling load, then the winter cycle may be affecting the outcome and lowering the star rating.
- If the cooling load is much higher than the heating load, the summer cycle may be affecting the outcome and lowering the star rating.
- If the heating and cooling loads are close and the star rating is low, both summer and winter cycles may be affecting the star rating.

13.2.2 Step 2: Analyse the performance by zone

NatHERS software contains analysis tools that allow an assessor to analyse the performance of each zone and produce detailed annual temperature profiles along with other useful data. These tools allow comparisons by zone of internal temperatures, outdoor temperature, energy use, etc. This stage involves reviewing the detailed reports or the detailed simulation outputs and identifying specific areas of interest. Depending on the software tool, this information may be displayed differently.

Once the areas of interest have been identified, an assessor can start to put together reasons why the zones have been affected (see [Chapter 5](#)). For example, the following scenarios may be identified:

- A very small zone is contributing a disproportionately high amount of energy to the overall result.
- A zone, such as a bedroom, is consuming the most amount of energy where this would be expected more of a living area.
- All zones are performing equally poorly, indicating there is a whole-dwelling issue, such as poor dwelling orientation, window placement and/or shading.

13.2.3 Step 3: Test improvement options

In this stage, assessors should apply a range of options depending on the results of steps 1 and 2, with reference to the principles of dwelling thermal performance (see [Section 2.6](#)) and tips on achieving the rating goal according to whether the issue is with the heating or cooling load (see [Section 13.3](#)).

It is best practice for assessors to test options on a base file and only make one change at a time. The base file (initial rating) should be saved separately and a copy should be used for analysis and testing. Assessors should record each test conducted. Recording this information in a table can be useful for incorporating possible changes into a report and/or discussing with the client.



13. FINALISING THE ASSESSMENT

The result of each change may also need to be evaluated for cost versus benefit and a table can assist an assessor and client to see which changes are cost effective in relation to the impact they have on the rating. For example, if an expensive option such as double glazing only makes a difference of 5 MJ/m² per year, the assessor (and client) may decide the cost outweighs the benefit.

Table 13-1: Example analysis to explore rating improvement options

Run #	Inclusions	Heating	Cooling	Total	Star rating	Change in heating	Change in cooling	Change in total	Change in star rating	Cost
Base	Base specification	102	43	145	5					
2	Base + R 3.5 ceiling	80	40	120	5.5	22	3	25	0.5	\$\$
3	Base + dark roof	98	44	142	5	4	-1	3	0	\$
4	Run 2 + R 2.0 wall	65	35	100	6	15	5	20	0.5	\$

13.2.4 Step 4: Select the final inclusions

The process outlined in Step 3 should be repeated, in consultation with the client, until the design reaches the rating goal. Assessors can also consider options for going beyond the rating goal because some minor design changes can deliver a much higher rating at no, or at a reduced, cost. For example, moving windows in a particular design from the east and west to the north wall of bedrooms can deliver a significant no-cost increase in the rating of the dwelling.

Consultations with the client may involve presenting:

- a single cost-effective and feasible option to achieve regulatory compliance
- several options for the client to select their preference
- a detailed analysis of rating options with a suggested option and reasons why
- some ratings and outputs to facilitate a discussion of options that could be tested to achieve the desired outcome (especially on a difficult or noncompliant rating)
- design advice (and associated rating evidence) to enable further design to take place (this is best if the assessor is involved early in the project).

13.2.5 Step 5: Amend the drawing set

13a Assessors must ensure that any recommendations are agreed to by the client and any amendments are included in the final drawing set and documentation. (**Tech Note clauses 3.3 and 3.4**)

Assessors should return a marked-up set of drawings or a list of notations to the client or author to allow the drawings to be amended. The new drawings then become part of the formal documentation for certification and the new version number on the re-submitted drawings are the ones that should be cited on the NatHERS Certificate.

Assessors must not amend the drawings unless they are the original author.



13.3 Tips to achieving the rating goal

Options for adjusting the heating and cooling load are listed below. The lists are in no particular order. Assessors should be aware of the approximate financial impact of any suggestions, and free or low-cost options should be selected before more costly changes, depending on the budget and client preferences. For further information about cost savings options, see the NatHERS *Cost savings through building redesign* report:

www.nathers.gov.au/publications/research-report-cost-savings-through-building-redesign-part-1 and www.nathers.gov.au/publications/research-report-cost-savings-through-building-redesign-part-2.

13.3.1 Improving the heating load

If the heating load is much higher than the cooling load, the winter cycle may affect the outcome and lower the star rating. If possible, improvements should be made at the relevant design stage, and may include but are not limited to:

- selecting **dark colours** on the roof and external walls
- improving **dwelling sealing** including weather seals and draft stopper on exhaust fans (note the NCC contains requirements for sealing dwellings; ensure suggestions do not contradict these requirements)
- increasing wall, ceiling and roof **insulation**, including deleting downlights that create holes in the ceiling insulation coverage (insulation is a relatively cost-effective way of improving a rating and minimising energy transfer, however some high-performance ceiling and wall batts can be expensive and improving other elements such as glazing could prove more cost effective)
- insulating **internal walls** between conditioned and unconditioned spaces, including the wall between the house and the garage
- insulating **under floors** and using soft **floor coverings** such as carpet, cork, vinyl and floating timber to help to insulate the floor, or try deleting the carpet if the bedrooms or living areas face north and a thermal mass floor is included (discuss with the client the impact and role that removable rugs could play)
- ensuring the **glazing to floor area ratio** is moderate, depending on the glazing systems used
- using **glazing units** with a low U-value/U_w (less than 4.0) and high solar heat gain coefficient (SHGC_w; more than 0.5); always use the best glazing the budget allows
- limiting **glazing** to the south (reduces heat loss) and/or increase glazing to the north (increases solar heat gain)
- decreasing the width of **shading** devices to allow more heat from the sun in during winter
- installing **operable shading** devices that allow shading in summer and maximum solar heat gain in winter
- decreasing **roof ventilation** (note the NCC has requirements for roof spaces that are not ventilated; exhaust fans must be ducted externally to prevent condensation in the roof, which can ultimately lead to material decay and structural failure; ensure suggestions do not contradict these requirements)
- decreasing **subfloor ventilation** (note the NCC contains minimum ventilation requirements for areas under raised floors; ensure suggestions do not contradict these requirements)
- decreasing **thermal mass**, as the climate and sun hours available may not be enough to heat the materials sufficiently
- investigating the use of **slab edge insulation**, **under-slab insulation** or a **waffle pod slab** (a waffle pod slab will not significantly affect the cost, but the design provides both insulation and ground coupling and will benefit the rating in both summer and winter)
- re-positioning the dwelling's **orientation or windows** to ensure living areas and/or the longer face of the dwelling have north-facing windows
- **re-designing** to incorporate northern orientation of living areas, zoning of the dwelling and suitable construction and materials.

13. FINALISING THE ASSESSMENT

13.3.2 Improving the cooling load

If the cooling load is much higher than the heating load, the summer cycle may affect the outcome and lower the star rating. Options to improve this may include but not limited to:

- selecting **light colours** on the roof and external walls
- using **reflective insulation** in the walls and roof (reflecting the heat away from the dwelling reduces the amount of energy available for transfer through the building elements)
- adding **sarking** under a tiled roof
- using **hard floor coverings** including polished concrete and ceramic tiles (these help to keep the spaces cooler if they do not receive direct sun)
- ensuring the **glazing to floor area ratio** is moderate; a value of between 20% and 35% is recommended, depending on the glazing systems used
- using **glazing units** with a moderate U-value/ U_w (more than 4.0) and low SHGC w (less than 0.5); always use the best glazing the budget allows
- limiting **glazing** (or adding shading devices) to the east and west to reduce heat gain
- installing or increasing the width of **shading** devices, especially to the north, west and east
- installing **operable shading** devices that allow full shading in summer and maximum solar gain in winter where appropriate
- relocating doors and other **openings** to maximise cross-ventilation paths from one side of the dwelling to the other
- installing **ceiling fans** to mechanically circulate and move the air inside the dwelling (note: there may be variations between how states and territories treat ceiling fans in the NCC; ensure suggestions do not contradict these requirements)
- increasing roof **ventilation** using whirly birds and eave vents (note: eave vents are necessary for whirly birds to function correctly, and the NCC also contains fire safety requirements for sealing eaves; ensure suggestions do not contradict these requirements)
- increasing **thermal mass** by installing feature walls or changing the floor construction to a slab-on-ground design, which couples the dwelling with the earth and provides stable temperatures under the floor
- investigating the use of **slab edge insulation**, **under-slab insulation** or a **waffle pod slab** (a waffle pod slab will not significantly affect the cost, but the design provides both insulation and ground coupling and will benefit the rating in both summer and winter).

13.3.3 Improving both the heating and cooling loads

If both loads require adjustment, a combination of the previous suggestions should be tested.

13.4 Certification

When an assessor has finalised the design and rating, a NatHERS certificate can be produced to demonstrate the dwelling has achieved compliance with the NCC or other requirements and generate stamps to include on the dwelling documentation.



13. FINALISING THE ASSESSMENT

13.4.1 Certification requirements

The following items must be produced for certification of a NatHERS assessment:

- a set of drawings (see [Section 2.2.1](#)), comprising of (at a minimum):
 - site plan
 - floor plan(s)
 - elevations
 - sections
 - electrical or lighting layout/information
 - window schedule or information (including size, glass and frame type and opening style)
- construction material details and/or specification (if in addition to the information provided on drawings)
- NatHERS stamp (stamped on each page of the documentation that relates to the assessment)
- QR code (within the certificate and stamp)
- AAO stamp (if required by the AAO)
- NatHERS Certificate.

13b Assessors must ensure that all the information used in the rating is on the final set of approved drawings. This detail may be documented by the architect or building designer as:

- graphical representations (standard industry drawing of wall types, material types, etc)
- notations either in a list or throughout the drawing set.

Assessors may want to consider how the NatHERS Certificate and stamped documentation are going to be used, and to ensure any modelling assumptions that have been made are well documented throughout the process and communicated clearly. Additionally, it may be appropriate for assessors to provide the stamped drawings and NatHERS Certificate together as one pdf package to ensure the documents are kept together.

13.4.2 Producing a certificate

The NatHERS software tools can be used in conjunction with an online certification portal to produce a certificate once all the data has been entered and the design finalised. Assessors should refer to the relevant software tool manual on how to generate the certificate.

13c For Class 2 buildings, each individual dwelling or unit must have an individual NatHERS certificate and the entire building must have a NatHERS summary certificate. (**Tech Note clause 13.6**)

Many states and territories require a minimum star rating for each individual dwelling, as well as an average rating for all the dwellings in a building. The summary certificate must show this information. Note, requirements differ between jurisdictions and assessors should refer to specific requirements of the relevant jurisdiction.

NCC 2019 NatHERS Certificate examples are shown in Figures [13-1](#) and [13-2](#) and NCC 2022 NatHERS Certificate examples are shown in Figures [13.3](#), [13.4](#), [13.5](#) and [13.6](#) below.

Further [examples of the NatHERS Certificate](#) and an [explanation of the changes to the NatHERS 2022 Certificate](#) are available on the NatHERS website.



13. FINALISING THE ASSESSMENT



Figure 13-1: NatHERS Certificate produced by an Accredited Assessor (left) for NCC 2019



Figure 13-2: NatHERS Certificate produced by a non-accredited Assessor (right) for NCC 2019



Figure 13-3: NatHERS Certificate thermal only produced by an Accredited Assessor (left) for NCC 2022



Figure 13-4: NatHERS Certificate Whole of Home produced by an Accredited Assessor (right) for NCC 2022

13. FINALISING THE ASSESSMENT



Figure 13-5: NatHERS Certificate thermal only produced by a non-Accredited Assessor (left) for NCC 2022

Figure 13-6: NatHERS Certificate Whole of Home produced by a non-Accredited Assessor (right) for NCC 2022

13d At the request of a client, a single Class 2 summary certificate can be produced for buildings that are combined and share a lot (e.g. by a bridge, shared underground space or an enclosed walkway), where NCC requirements for combined buildings are met. (**Tech Note clause 13.6**)

This requirement means that each dwelling (or sole-occupancy unit) will still be required to have individual certificates but only one summary certificate that covers all the buildings is required. This is only to occur when requested by the client, as the client needs to be mindful of NCC and state/territory jurisdictional requirements that may be affected by this decision for compliance purposes.

13.4.3 Stamping requirements

13e Before stamping drawing sets with the NatHERS QR code stamp or issuing a NatHERS certificate, assessors must confirm all requirements detailed in the NatHERS Technical Note have been met and that the information in the assessment aligns with the design documentation. (**Tech Note clauses 13.1 to 13.4**)

To be complete, the drawing set must include the requirements outlined in the NatHERS **Technical Note clauses 3.3 and 3.4** (also noted in Section 2.2.1 of this handbook).

13f If any details are not present on the drawings, or differ from the rating assessment, the assessor must return the drawing set to the client or author of the drawings for the information to be added and new drawing versions issued. (**Tech Note clause 3.4**)

Details on the drawing set and relevant schedules, addendums and specifications must align with the assessment and vice versa. The only exception to this is where default values have been applied (see Page 2.3).

13.4.4 Stamping of design documentation

13g The NatHERS QR code stamp must be added electronically to all design documentation that is relevant to the NatHERS assessment. As a minimum this includes but is not limited to:

- site and floor plans
- elevations and sections
- materials documentation
- window, skylight and door schedules
- shadow drawings
- electrical plans including lighting and mechanical ventilation
- insulation information where provided (e.g. contained with construction drawings)
- appliance schedule
- any design amendments
- supporting reports.

The stamp should not obscure any information on the design documentation or the mark of any other practitioner. **(Tech Note clause 13.2)**

13h Assessors must follow directions from their AAO and include their AAO stamp when required. **(Tech Note clause 13.3)**

13i For Class 2 dwellings, the NatHERS Class 2 summary QR code stamp is to be stamped on each page of the documentation that is relevant to the NatHERS assessment. **(Tech Note clause 13.4)**



This glossary is intended to assist readers with understanding terms and acronyms mentioned throughout the handbook. Definitions are expressed within the context of energy efficiency and conducting a NatHERS thermal performance assessment.

Term	Definition
A and B type windows (NatHERS definition)	<p>NatHERS terminology used to define which default window should be selected for a specific openable sash.</p> <p>A and B type windows do not necessarily align with window IDs in NatHERS software tools and have no association or significance to Australian Fenestration Rating Council ratings or window manufacturers. For typical classifications of A and B type windows, refer to Chapter 8 Windows and doors of this handbook.</p>
air tightness	<p>The level of uncontrolled air movement or infiltration into and out of a building, measured in air changes per hour at 50 pascals pressure differential (ACH50).</p> <p>The Chenath engine underpinning NatHERS software tools automatically calculates air tightness infiltration based on the terrain specified, stack and wind infiltration factors, and weather file data (e.g. hourly wind speed).</p>
angle of incidence	<p>In relation to windows, the angle that solar radiation strikes glass.</p> <p>When the sun is perpendicular to the glass it has an angle of incidence of 0°. As the sun angle increases, the effective area of exposure to solar radiation reduces, more solar radiation is reflected and less is transmitted through the glass.</p>
artificial heating or cooling	<p>Mechanical heating, and cooling equipment or appliances. Heating or cooling that is not from a passive heating or passive cooling source.</p>
assessor	<p>The person assessing the energy rating using a NatHERS software tool to determine the thermal performance of a dwelling. An assessor is sometimes referred to as a thermal performance assessor (or TPA).</p> <p>To practice as a NatHERS Accredited Assessor, assessors must hold a Certificate IV in NatHERS Assessment qualification and maintain accreditation with an Assessor Accrediting Organisation.</p> <p>Accredited assessors have also completed training and maintain competency in one or more relevant NatHERS accredited software tool(s).</p> <p>State and territory building regulators have specific requirements as to whether assessments for compliance purposes must be completed by an Accredited Assessor or can be completed by non-accredited assessors.</p> <p>In this handbook, the term 'assessor' refers to accredited and non-accredited assessors, unless stated otherwise.</p>

14. DEFINITIONS

Term	Definition
Assessor Accrediting Organisation (AAO)	A professional organisation with responsibility for accrediting assessors and ensuring they deliver reliable and consistent energy ratings. The AAOs currently operating in Australia are listed on the NatHERS website at: https://www.nathers.gov.au/assessors
Australian Building Codes Board (ABCB)	A National Cabinet standards writing body that is responsible for the development of the National Construction Code .
Australian Fenestration Rating Council (AFRC)	The Australian arm of the US-based National Fenestration Rating Council . The role of the AFRC is to develop, administer and approve comparative energy and related fenestration rating programs that serve the public and satisfy the needs of its private sector partners. They do this by providing fair, accurate, credible and user-friendly information on fenestration product performance.
Australian Glass and Window Association (AGWA)	A membership association of the Australian fenestration industry, comprising nearly 600 window manufacturers and industry suppliers throughout Australia. In 2019, Australian Window Association (AWA) merged with Australian Glass and Glazing Association (AGGA) to form AGWA.
Australian Standard	Documents that set out specifications, procedures and guidelines that aim to ensure that products, services and systems are safe, consistent and reliable. Australian Standards® are developed by a national standards body (like Standards Australia) or other accredited bodies or are adoptions of international standards. These standards become mandatory when referred to in Australian or state and territory legislation. For Australian Standards® referenced in legislation, visit www.standards.org.au . Standards Australia is recognised through a memorandum of understanding with the Australian Government as the peak non-government standards development body in Australia. Standards Australia has produced a Glossary of Building Terms (HB 50—2004) of approximately 11,000 construction industry terms.
average energy consumption per unit area per year (MJ/m²/yr)	The thermal energy load measurement used for NatHERS star bands relevant to each climate zone . It measures a predicted energy consumption per unit area – megajoules per square metre per year.
Building Code of Australia (BCA)	Minimum technical provisions for the design and construction of buildings and other structures in Australia. The BCA forms volume one and volume two of the National Construction Code . It is produced and maintained by the Australian Building Codes Board on behalf of the Australian Government and state and territory governments. State and territory variations from the national provisions are included in appendixes within each volume of the National Construction Code .
Building Sustainability Index (BASIX)	An online assessment tool used as part of the development application process in New South Wales when seeking approval to build. BASIX assesses elements of a proposed design against sustainability targets and is implemented under the <i>Environmental Planning and Assessment Act 1979</i> .



14. DEFINITIONS

Term	Definition
Chenath engine	<p>The software engine developed by CSIRO that underpins the NatHERS Benchmark Tool and other accredited NatHERS software tools.</p> <p>The engine is based on decades of scientific research into the way residential buildings operate in Australian conditions, and uses climate data and average user behaviour, among other factors, to predict the annual energy loads for dwellings. Factors used in the engine, such as underlying assumptions, air infiltration and how air flow is modelled, can be found in the Chenath repository at https://hstar.com.au/Home/Chenath.</p>
clerestory window	<p>A window or series of windows along the top of a dwelling's wall, usually at or near the roof line and commonly considered above 'eye level'.</p> <p>Clerestory windows are a type of fenestration or glass window placed to let in light or allow ventilation.</p>
climate zone (NatHERS definition)	<p>Regions of similar climatic conditions.</p> <p>NatHERS divides Australia into 69 different regions of similar climatic conditions; each is referred to as a NatHERS climate zone. Climate zones are generally aligned with postcode boundaries for convenience, except where there is likely to be a topographical or other feature within the postcode area that affects the local climate. An interactive climate zone map is available on the NatHERS website at: https://www.nathers.gov.au/nathers-accredited-software/nathers-climate-zones-and-weather-files</p> <p>NatHERS climate zones differ from National Construction Code climate zones.</p>
Commonwealth Scientific and Industrial Research Organisation (CSIRO)	<p>An Australian Government corporate entity responsible for scientific research to improve the economic and social performance of industry for the benefit of the community.</p> <p>CSIRO is constituted by and operating under the provisions of the Science and Industry Research Act 1949. CSIRO developed and maintains the Chenath engine used in NatHERS software tools.</p>
compact fluorescent lamp (CFL)	<p>A type of lamp using a phosphor-coated tube technology, designed to replace an equivalent sized general-service incandescent lamp/globe with greater efficiency and life span.</p>
conduction	<p>The transfer of heat from one substance to another by direct contact.</p> <p>Conductive loss or gain is the loss or gain of heat directly through contact with a person, object or floor.</p>
construction systems	<p>The combination of materials used to build the main elements of a dwelling – roof, floor and walls.</p>
convection	<p>The transfer of heat through the circulation of currents from one region to another by the movement of fluids (gas or liquid).</p> <p>In dwellings, convective heating is the process of using the natural circulation of air across a heat source to warm a space. Convective cooling (or stack ventilation) is the upward or downward movement of air through openings in the dwelling envelope, resulting from thermal buoyancy and/or negative pressure generated by the wind when there is a height difference between the air intake and the air outlet.</p>



14. DEFINITIONS

Term	Definition
cooling load	<p>The predicted amount of heat energy that would need to be removed from a space (through cooling) to maintain the temperature in an acceptable range.</p> <p>NatHERS cooling and heating loads, sometimes referred to as 'thermal loads', take into account the dwelling's construction and insulation (including floors, walls, ceilings and roof), and the dwelling's glazing and opening details (including size, performance and shading).</p>
custom window (NatHERS definition)	<p>Terminology used by NatHERS to define a fenestration product on the market that has obtained an Australian Fenestration Rating Council (AFRC) rating, has properties and description detailed on the Window Energy Rating Scheme website and has been included in the AFRC Custom Window Library used in NatHERS software tools.</p> <p>Custom windows should not be confused with 'custom-made' products, or a product that may be available on the market or has obtained an AFRC rating but has not been included in the AFRC window library file used in NatHERS software tools.</p>
default values or provisions	<p>Standard values in NatHERS software tools for modelling certain elements of a dwelling, so an assessment can be completed when some aspects of the design are unknown.</p> <p>Default values are only to be used where specified in the NatHERS Technical Notes, or when there is insufficient information in the design documentation and the client cannot clarify the specific details. Some provisions are worst case, and the rating may be adversely affected. For more information on provisions, refer to the current NatHERS Technical Notes. Previous NatHERS Technical Notes and NatHERS guidance referred to these as 'default settings' or 'defaults'.</p>
default window (NatHERS definition)	<p>Terminology used by NatHERS to define a generic fenestration product considered representative of a specific range of window products, whose properties have been derived by statistical methods and is included in the Default Window Library in NatHERS software tools.</p> <p>Previously known as 'generic windows', these products have no correlation with actual fenestration products supplied by any company but allow a thermal assessment to be conducted when the actual fenestration product is not known or the custom window is not available in the Custom Window Library.</p>
documentation	<p>The set of materials that describe the dwelling to be built and are used in a NatHERS assessment.</p> <p>Documentation consists of plans, drawings, specifications, schedules and addendums that may relate to the rating or assessment. The terms 'documentation', 'design documentation', 'drawing sets' and 'plans' may be used interchangeably in this handbook.</p>
dwelling	<p>A self-contained unit of accommodation used by its occupants to reside in.</p> <p>For the purposes of NatHERS and this handbook, this refers to a house, unit or apartment that is undergoing a NatHERS assessment.</p>



14. DEFINITIONS

Term	Definition
dwelling envelope	<p>The physical separator between the dwelling being assessed and the outside environment or neighbour.</p> <p>The dwelling envelope comprises a dwelling's walls/windows/doors, roofs and floors, and includes the resistance to air, water, heat, light and noise transfer. When modelling in NatHERS software tools, the dwelling envelope includes both conditioned and unconditioned zones. This is different to the National Construction Code definition of a building/thermal envelope, which is defined as the building's fabric that separates artificially heated and cooled spaces from the exterior of the building or other spaces that are not artificially heated or cooled.</p>
emissivity	<p>The ratio of radiant heat emitted from a building surface compared to that of a perfect emitter, also known as a black body.</p> <p>It is expressed as a number between 0 and 1. Low emissivity is more reflective, high emissivity is less reflective. Most building materials will be 0.9. Reflective foils vary from 0.03 to 0.2 for surfaces with an anti-glare coating.</p>
energy efficiency	<p>The ratio of the amount of energy required to provide a given service.</p> <p>For example, a 5 watt LED lightbulb produces the same amount of light as a 75 watt incandescent lightbulb, while using 93% less energy, resulting in higher energy efficiency. An energy-efficient dwelling will use less energy to achieve thermal comfort compared with a dwelling that is less energy efficient.</p>
energy transfer	<p>The movement of energy through the dwelling envelope.</p> <p>Energy transfer occurs mainly because of conduction. Conduction occurs through walls (both external and internal), floors, ceilings roofs, glazing and skylights.</p> <p>Energy transfer can also occur by radiation from surfaces and through windows, and by convection, such as in roof spaces. Energy transfer through a dwelling can be controlled through various insulating qualities, by careful sizing of various elements, the dwelling design (i.e. grouping similar zones) and dwelling shape (i.e. less external wall area).</p>
fenestration	<p>Any glass opening in a dwelling envelope, most notably windows, doors, louvres and skylights.</p>
frame fraction	<p>The ratio of frame to glass in a fenestration product.</p>
ground reflectance	<p>The amount of solar radiation reflected by the ground.</p> <p>Reflectance of the surface of a material is its effectiveness in reflecting radiant energy.</p>
heat pump	<p>A heat pump uses an electric heat exchanger to extract heat from the air to heat the home. One type of heat pump is a reverse cycle air conditioner. Because it transfers rather than generates heat, the heat pump can efficiently provide comfortable temperatures for a home.</p>
heating load	<p>The predicted amount of heat energy that would need to be added to a space (through heating) to maintain the temperature in an acceptable range.</p> <p>Heating and cooling loads, sometimes referred to as 'thermal loads', take into account the dwelling's construction and insulation (including floors, walls, ceilings and roof), and the dwelling's glazing and opening details (including size, performance and shading).</p>



14. DEFINITIONS

Term	Definition
infiltration	<p>Uncontrolled air movement due to breaks in the dwelling's envelope, such as air leakage through construction gaps and unsealed penetrations.</p> <p>For example, unsealed downlights can create an uncontrolled infiltration path by allowing air to escape from the rooms to the roof. This affects the air tightness of the dwelling. Infiltration should not be confused with controlled air movement or ventilation.</p>
insulated glass unit (IGU)	Combination of two or more glazing layers sealed with a gas-filled or vacuum gap between the layers (e.g. double or triple glazing).
k-value	<p>Thermal conductivity, or the measure of the rate of heat flow through a material and the ability of a material to allow the flow of heat from its warmer surface through the material to its colder surface.</p> <p>k-value is determined as the heat energy transferred per unit of time and per unit of surface area divided by the temperature gradient, which is the temperature difference divided by the distance between the two surfaces (the thickness of the material), expressed in watts per meter-kelvin. A material with a low k-value transmits low levels of heat (good insulator); a material with a high k-value transmits high levels of heat (poor insulator).</p>
light emitting diode (LED)	<p>A form of lighting that illuminates through the movement of electrons in a semiconductor material.</p> <p>An LED lamp can replace an equivalent sized general-service incandescent lamp or a CFL with greater efficiency and life span.</p>
low emissivity (low e) glass	A type of glass that has a low thermal emissivity coating applied to reduce the transmission of heat.
mullion	<p>A vertical element of a window frame that forms a division between units of a window, door or screen.</p> <p>A mullion can be used decoratively, or to provide added rigid support to the glazing of large glass windows.</p>
NatHERS Certificate	<p>A document produced by NatHERS accredited software tools that summarises the predicted thermal performance of a dwelling and lists the features contributing to the calculated NatHERS star rating.</p> <p>NatHERS certificates are produced by an accredited NatHERS Assessor or a non-accredited assessor and are primarily used to verify compliance with the National Construction Code. NatHERS previously referred to this as the NatHERS Universal Certificate, or UC.</p>
National Construction Code (NCC)	<p>A set of documents that outline the minimum necessary requirements that must be met by all new dwellings (and new work to existing dwellings) throughout Australia.</p> <p>The NCC is a performance-based code comprising the Building Code of Australia, volume one and volume two; and the Plumbing Code of Australia, volume three.</p>



14. DEFINITIONS

Term	Definition
National Fenestration Rating Council (NFRC)	<p>A United States non-profit organisation that establishes objective window, door and skylight energy performance ratings to help the public compare products and make informed decisions.</p> <p>The Australian Fenestration Rating Council is the Australian arm of the NFRC, with a signed memorandum of understanding so that the intellectual property of the NFRC can be shared with their Australian counterpart.</p>
Nationwide House Energy Rating Scheme (NatHERS)	<p>The national scheme in Australia that provides a star rating system for the potential energy efficiency of dwellings.</p> <p>NatHERS accredits residential building thermal modelling software tools used to estimate a dwelling's potential heating and cooling use, to verify compliance with the NCC or for design purposes. NatHERS also accredits assessor accrediting organisation.</p>
north—true and magnetic	<p>True north, also known as true geographic north, is a constant fixed direction on Earth's axis. True north is used in NatHERS software tools and is usually displayed on drawings of dwelling plans.</p> <p>Magnetic north is the direction from any point on Earth towards Earth's magnetic north pole. Magnetic north therefore varies in position as the magnetic pole moves continually over time. A compass is based on magnetic north, whereas Google Earth is based on true north.</p>
orientation	Positioning of a building in relation to north, seasonal variation in the sun's path and prevailing wind patterns.
party wall	A dividing partition between two adjoining buildings or units; also a division between separate units in a multi-unit apartment complex. This is sometimes called a 'common wall' when used for adjoining dwellings.
passive cooling	A system of features and/or technologies incorporated into a dwelling's design to use and maximise the effects of prevailing breezes to cool the dwelling, with the aim of minimising the need for mechanical cooling that consumes power.
passive design	Design that takes advantage of the climate to maintain a comfortable temperature range in the dwelling with minimal need for mechanical heating and cooling that consumes power.
passive heating	A system of features and/or technologies incorporated into a dwelling's design to use and maximise the effects of the sun's natural capability to heat the dwelling, with the aim of minimising the need for mechanical heating that consumes power.
photovoltaic	A method of generating electrical power by converting solar radiation into direct current electricity.
R-value	<p>Thermal resistance per unit area, or the measure of the resistance to heat flow through a specific thickness of a material.</p> <p>Higher numbers indicate better insulating properties. Thermal resistance (R-value) is the inverse of thermal transmittance (U-value). 'Total R-value' refers to the addition of each material/component's R-value. 'Added R-value' refers to the insulation material/component to be added to a wall, roof or floors to improve the thermal resistance of that system.</p>



14. DEFINITIONS

Term	Definition
recessed light fitting	A light which partially or wholly sits within a roof, wall or floor cavity so that its face is flush, or nearly flush with the internal surface of the room. The most common examples are downlights.
residential building	A structure used by its occupants to reside in. When modelling in NatHERS software tools, residential buildings refer to Class 1 buildings, attached Class 10a buildings, and sole-occupancy units of Class 2 or Class 4 parts of a building, as defined in the Building Code of Australia .
roof window (NatHERS definition)	A glazed element, either fixed or openable, penetrating the roof construction and located in a roof/ceiling that does not have a roof/attic space. This may differ from a broader definition of roof window characteristics, and specifically differs to the NatHERS definition of a skylight .
sarking	A foil product that is often, but not always, reflective and is used to wrap around buildings to provide thermal insulation, moisture barrier and/or air tightness . It may also refer to a layer of boards or bituminous felt placed beneath tiles or other roofing to provide thermal insulation.
skylight (NatHERS definition)	A glazed element that is fixed and therefore not ventilated, penetrating the roof construction and connected to a zone by a built-in shaft that passes through a roof/attic space. This may differ from a broader definition of skylight characteristics, and specifically differs to the NatHERS definition of a roof window .
small air space	An area in a dwelling, such as small pantries, built-in robes, plumbing voids, wall voids, return air ducts and other small non-habitable areas. For example, a small pantry is one that cannot be walked into, as defined in the NatHERS Technical Note .
solar absorptance	A measure of the ability of an object to absorb solar radiation. For example, the proportion of the total incident solar radiation that is absorbed by roofing material (the remainder is reflected).
solar heat gain coefficient (SHGC)	The fraction of incident solar radiation admitted through a window, both directly transmitted as well as absorbed and subsequently released inward. SHGC is expressed as a number between 0 and 1. The lower a window's SHGC, the less solar heat it transmits. SHGC _w refers to the glazing measurement of how readily heat from direct sunlight flows through a window system.
solar reflectance	The fraction of solar radiation being reflected from a surface.
solar thermal electric boosted	Solar hot water systems consist of solar panels or evacuated tubes and a storage unit which is either installed on the roof or at ground level. In areas or during times when there is not enough sunshine to fully heat the water, an electric booster will kick in as a backup.
stack ventilation or stack effect ventilation	The upward or downward movement of air through openings in a dwelling envelope due to thermal buoyancy and/or negative pressure generated by the wind over the roof. It is a type of convective air movement that occurs when there is a height difference between the air intake and the air outlet.



14. DEFINITIONS

Term	Definition
star band	The range of star ratings set for each NatHERS climate zone . Star bands allow fair comparisons of dwellings despite regional variability in weather conditions across Australia. Each star band is based on the average energy consumption per unit area per year (MJ/m ² /yr). The star bands for different climate zones are available on the NatHERS website at: https://www.nathers.gov.au
star rating or NatHERS stars	The system used by NatHERS to score the thermal comfort of a dwelling, ranging from 0 to 10. NatHERS software tools model the average total energy load for a building and this determines its star rating. A 0-star-rated dwelling gives practically no protection from hot or cold weather; a 5-star dwelling indicates a moderate level of thermal performance, but still requires artificial heating and cooling; a 10-star dwelling is unlikely to need any artificially heating or cooling.
(NatHERS) Technical Note	The document that sets out the NatHERS requirements for undertaking thermal performance assessments and rating dwellings in regulatory mode (e.g. <i>Technical Note version 1.2 2014</i>). The NatHERS Technical Note ensures that ratings are conducted consistently.
terrain exposure	How open the area surrounding a dwelling is. The terrain exposure affects the dwelling's access to ventilation and thus can affect the temperature in a dwelling.
thermal break	A thermal break or a thermal barrier is the opposite of a thermal bridge. It includes any material that interrupts the conduction of heat or cold between building elements. Thermal breaks counteract the effects of thermal bridging, reducing heat loss and/or gain and subsequently improving the overall energy efficiency of a building.
thermal bridging	A path of least resistance for heat transfer between conductive materials. This occurs when a more conductive (or poorly insulating) material allows heat flow between a conditioned and unconditioned space or outside. For example when a series of nails or a metal beam penetrates through insulation, creating a bridge between the inside and the outside.
thermal comfort	A person's subjective feeling of how comfortable the surrounding environment is, in response to a mix of properties such as temperature, air flow and humidity.
thermal conductivity	The capacity of a material to conduct heat and allow the flow of heat from its warmer surface through the material to its colder surface, also known as k-value . It is determined as the heat energy transferred per unit of time and per unit of surface area divided by the temperature gradient, which is the temperature difference divided by the distance between the two surfaces (the thickness of the material), expressed in watts per meter-kelvin. A material with a low k-value transmits low levels of heat (good insulator); a material with a high k-value transmits high levels of heat (poor insulator).



14. DEFINITIONS

Term	Definition
thermal mass	<p>The ability of a material to absorb and store heat energy (e.g. from the sun) or moderate the temperature of a space by remaining cool and heating slowly.</p> <p>A lot of heat energy is required to change the temperature of high-density materials such as concrete, bricks and tiles, so they are said to have high thermal mass. Lightweight materials, such as timber, do not store a lot of heat energy so have low thermal mass.</p>
thermal performance	<p>The effectiveness of a dwelling envelope to maintain acceptable levels of human comfort inside the building, relative to the outside weather conditions, through minimising the need for artificial heating or cooling.</p> <p>In relation to a particular building material or element, the extent to which the material or element reduces or promotes heat loss or heat gain.</p>
thermal resistance	<p>The measure of the resistance to heat flow through a specific thickness of a material, also known as R-value.</p> <p>Higher numbers indicate better insulating properties. Thermal resistance (R-value) is the inverse of thermal transmittance (U-value).</p>
thermal transmittance	<p>Also known as U-value, thermal transmittance is a measure of the heat transfer or flow per square meter through a specific thickness of material, divided by the difference in temperature across the material (measured in watts). Well-insulated elements of a dwelling have a low thermal transmittance, whereas poorly insulated parts of a dwelling have a high thermal transmittance. Thermal transmittance (U-value) is the direct inverse to thermal resistance (R-value) $-U = 1/R$.</p>
transom	<p>A transverse horizontal structural beam or bar, or a crosspiece, separating glazed panels (e.g. a door with a window above).</p> <p>A transom is generally used to allow additional light and increase glazing without increasing the glazed door size. It can also occur within larger window frames to separate dissimilar glazed panels.</p>
U-value	<p>The measure of the heat flow per square meter (measured in watts) through a specific thickness of material, such as a wall, floor, ceiling, roof or window;</p> <p>U-value is also known as thermal transmittance and is often expressed as U_w in windows. It demonstrates how well parts of a dwelling transfer heat. The lower the U-value, the better the insulating ability. Thermal transmittance (U-value) is the direct inverse to thermal resistance (R-value)—$U = 1/R$.</p>
ventilation	<p>The controllable movement of air through convection.</p> <p>Controlling ventilation means controlling the potential air paths through a dwelling. Factors such as dwelling orientation and location, window and door placement, window/door type and operability, and extraction fans can affect ventilation. Ventilation should not be confused with uncontrollable air movement through infiltration.</p>
waffle pod	<p>A type of concrete slab floor constructed by pouring concrete over a grid of polystyrene blocks known as 'void forms'.</p>



14. DEFINITIONS

Term	Definition
Window Energy Rating Scheme (WERS)	<p>A scheme that enables Australian Fenestration Rating Council (AFRC) rated windows of member fabricators to display star rating and comparable annual energy impact on a dwelling, in any climate of Australia.</p> <p>To participate in the scheme, window manufacturers must obtain energy ratings for their products from a rating organisation that is accredited by the AFRC and be a member of the Australian Glass and Window Association (AGWA). WERS is managed by the AGWA.</p>
wing wall	<p>Solid projections that are perpendicular to the plane of the 'subject wall' and cast shade on that wall.</p> <p>Wing walls may be created by the other walls of the dwelling, by a courtyard wall or adjoining structures. As well as shade, they also affect the flow of air around and through a dwelling. The Chenath engine modifies air flow through a dwelling based on the location and size of wing walls.</p>
zone (NatHERS definition)	<p>A defined space within a dwelling that is assumed to be operated in a particular way and is predominantly defined by permanent boundaries.</p> <p>For example, the kitchen zone assumes a higher heat load within the dwelling at 6–7 pm each day, to account for the predicted increase in appliance use while cooking.</p>



Acronyms and abbreviations

Acronym/Abbreviation	Meaning
AAO	assessor accrediting organisation
ABCB	Australian Building Codes Board
AFRC	Australian Fenestration Rating Council
AS	Australian Standard
AGWA	Australian Glazing and Window Association
BASIX	Building Sustainability Index
BCA	Building Code of Australia
BDAV	Building Designers Association Victoria
CSIRO	Commonwealth Scientific and Industrial Research Organisation
DWL	Default Window Library
IGU	insulated glass unit
MJ/m²	megajoules per square metre
NatHERS	Nationwide House Energy Rating Scheme
NCC	National Construction Code
NFRC	National Fenestration Rating Council
SA	solar absorbance
SHGC	Solar Heat Gain Coefficient
WERS	Window Energy Rating Scheme